

# Sealing Solutions

Solutions for all sealing applications



## Shaft Seal Catalog

Seals for rotating applications

Section	Series	Name	Material	Page
<b>INCH</b>	<b>SHAFT SEALS</b>			<b>SS 3</b>
	SHAFT SEALS	NOK	ALL	<b>SS 12</b>
		GLOBAL AVAILABILITY	NBR/STEEL	<b>SS 17</b>
	PRESSURE SEALS	JM CLIPPER NOK	ALL	<b>SS 47</b> <b>SS 51</b>
	SHAFT SEAL REFERENCE			<b>SS 57</b>
	<b>V-RINGS</b>			<b>SS 93</b>
	<b>SPRING-ENERGIZED ROTARY SEALS</b>			<b>SS 99</b>
	FLANGED SEALS MISC.			<b>SS 99</b> <b>SS 101</b>
	<b>SHAFT SEALS</b>			<b>SS 103</b>
	<b>METRIC</b>	SHAFT SEALS	SIMRIT	ALL
		GLOBAL AVAILABILITY	NBR/STEEL FPM/STEEL	<b>SS 141</b> <b>SS 225</b>
PRESSURE SEALS		NOK/SIMRIT	ALL	<b>SS 254</b>
<b>V-RINGS</b>				<b>SS 267</b>
V-RINGS				<b>SS 267</b>
AXIAL SHAFT SEALS				<b>SS 274</b>
END CAPS				<b>SS 276</b>
<b>SPRING-ENERGIZED ROTARY SEALS</b>				<b>SS 277</b>
FLANGED SEALS MISC.				<b>SS 277</b> <b>SS 279</b>



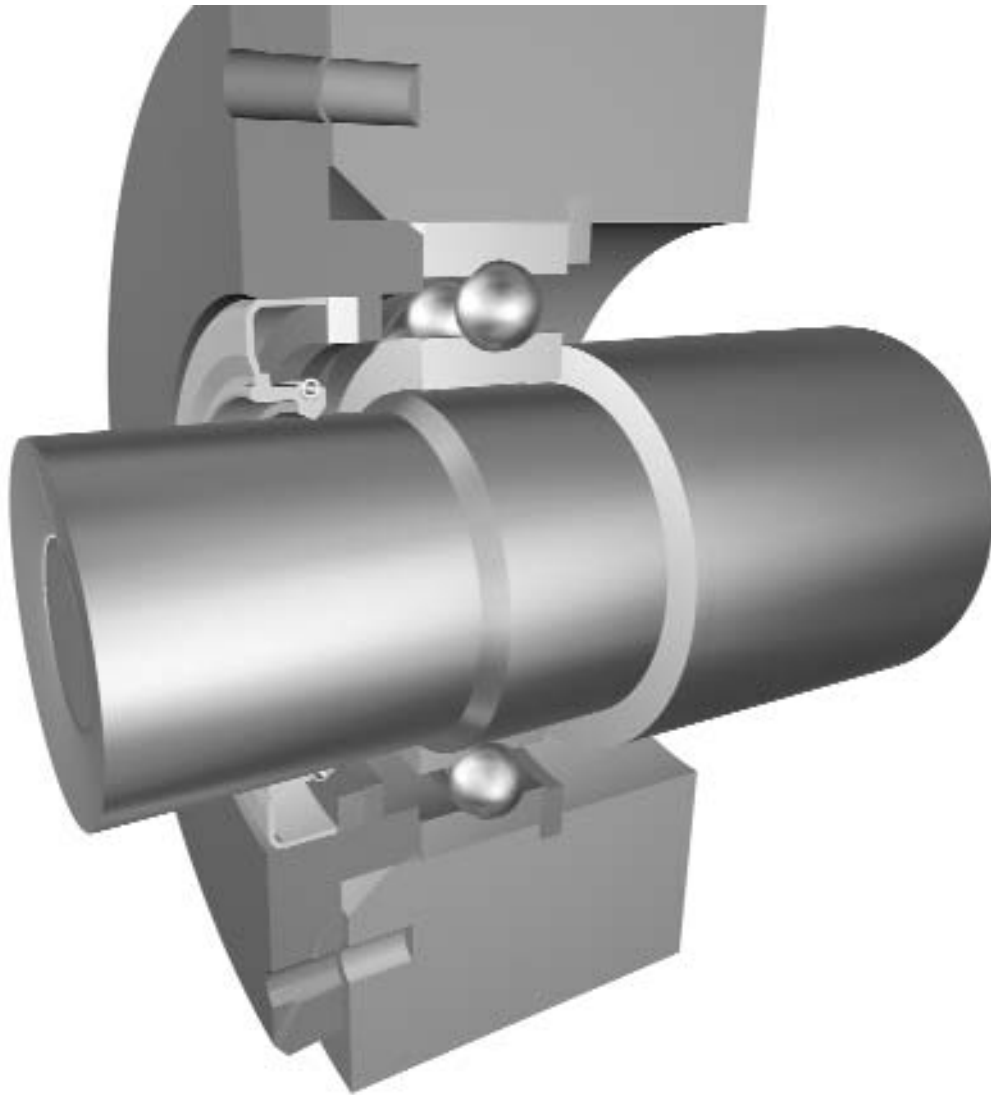











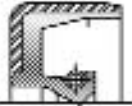
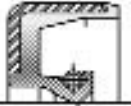









## DESIGN AND SELECTION FOR INCH AND JIS STANDARDS

### STANDARD SEAL DESIGNS

Table I illustrates the 22 basic standard designs commonly used on a variety of applications.

TABLE I. Freudenberg-NOK Standard Seal Type

Body Symbols		A2	B2	B	BR	C
		Material O.D. design with an inner case for greater structural rigidity	Most standardized and economical metal O.D. design	Metal O.D. design with fluid side rubber covered.	Metal O.D. design for greater O.D. sealing ability.	Rubber O.D. design for excellent O.D. sealing ability.
Lip Symbols	S	<b>SA2</b> 	<b>SB2</b> 	<b>SB</b> 	<b>SBR</b> 	<b>SC</b> 
	T	<b>TA2</b> 	<b>TB2</b> 	<b>TB</b> 	<b>TBR</b> 	<b>TC</b> 
V	V	<b>VA2</b> 	<b>VB2</b> 	<b>VB</b> 	<b>VBR</b> 	<b>VC</b> 
	K	<b>KA2</b> 	<b>KB2</b> 	<b>KB</b> 	<b>KBR</b> 	<b>KC</b> 
WP	WP	—	—	<b>WPB</b> 	—	<b>WPC</b> 
		—	—	—	—	—

NOTE:

Metal O.D. seals are most suitable for steel or cast iron housing materials.





Rubber covered O.D. seals are preferred for soft alloy or plastic housing materials and are suitable as well for steel or cast iron housings. Also, this design category is best for rough bore finishes or for materials with a high coefficient of thermal expansion.

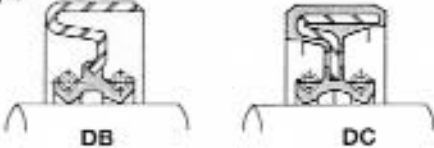
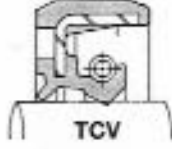
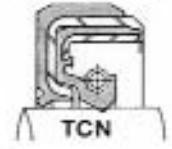
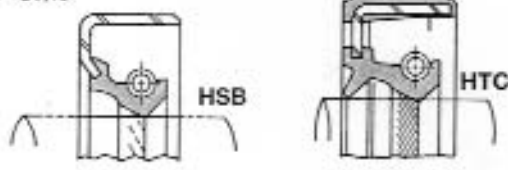
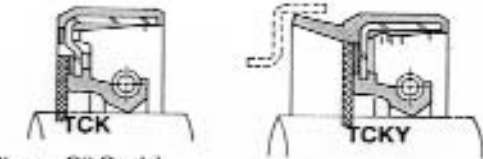

## NONSTANDARD DESIGNS

Special applications which cannot be adequately satisfied by standard designs are illustrated on Table IV.



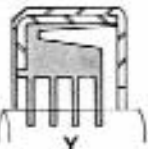
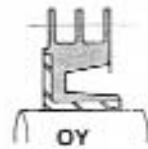

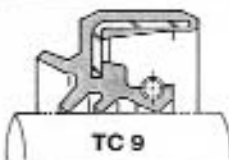

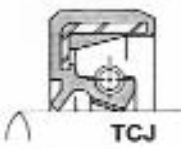
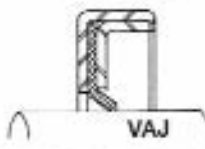



TABLE IV.

Freudenberg-NOK DESIGN	DESIGN CHARACTERISTICS
<p>"D" Style</p>  <p style="text-align: center;">DB                      DC</p>	<p>Applications which require separating two fluids from each other should use two garter spring loaded lips. The "D" style seal incorporates the two lips into one design. Note: The bore depth must be increased to accommodate the two seal lips.</p>
<p>"TCV" (Medium Pressure)</p>  <p style="text-align: center;">TCV</p>	<p>For applications up to 50 psi (3.5 kg/cm<sup>2</sup>), the "TCV" design is recommended. Pressure limit is dependent on shaft speed. Available for shaft diameters less than 2.500" (65 mm).</p>
<p>"TCN" (High Pressure)</p>  <p style="text-align: center;">TCN</p>	<p>Type "TCN" is designed for high pressure applications where continuous pressure may reach 150 psi (10.6 kg/cm<sup>2</sup>). Maximum pressure limit is dependent on shaft speed.</p>
<p>"H" Style</p>  <p style="text-align: center;">HSB                      HTC</p>	<p>Hydrodynamic sealing lips are available with majority designs. Both unidirectional and bidirectional helical ribs are available. The helical ribs help "pump" the oil weepage back under the seal lip. Basic lip design is same as standard seal.</p>
<p>"NF" (Fabric Auxiliary Lip)</p>  <p style="text-align: center;">TCK                      TCKY</p>	<p>Where dirt or dust ingestion is a problem, the "TCK" design provides superior exclusion. Where dust or dirt and moisture (small quantities of water) mixture are evident, combination with a slinger provides excellent results (TCKY).</p>
<p>"QL" (Sleeve Oil Seals)</p>  <p style="text-align: center;">QLN                      QLF</p>	<p>The "QL" seal is specially designed for mud or very dirty applications. Maximum shaft speed is limited to 10 ft/sec. (3M/sec.).</p>
<p>"T4" (Reciprocating)</p>  <p style="text-align: center;">TB4                      TC4</p>	<p>Severe reciprocating shaft applications where oil or oil-water fluid retention is desired can be effectively sealed by the "T4" design. Pressure up to 100 psi (7 kg/cm<sup>2</sup>) can be sealed, such as in shock absorbers.</p>
<p>"DK" (Reciprocating)</p>  <p style="text-align: center;">DKH                      DKB</p>	<p>Dust wiper for hydraulic cylinders. Not recommended for pressures above 5 psi (.35 kg/cm<sup>2</sup>).</p>

## NONSTANDARD DESIGNS

Freudenberg-NOK can supply a number of other special seals which are not usually standard in application nature. Table V illustrates a few of these designs.

TABLE V.

DESIGN TYPE	APPLICATION	EXAMPLE
VS	Valve Stem Seals	 VSW  VSB  VSB5
V	Special Mud Seals	 Y  OY
"5"	Flange Seals	 TC 5  TB 5
"9"	Side Lip Seal	 TC 9
"UJ"	Universal Joint Seals	 UJ  UJB
"RJ"	PTFE Seals	 TCJ  VAJ  SA1J
"O"	Rotating Bore	 OC
"E"	High Shaft Eccentricity	 SBE

INCH SIZE  
SHAFT SEALS



## SEAL NOMENCLATURE

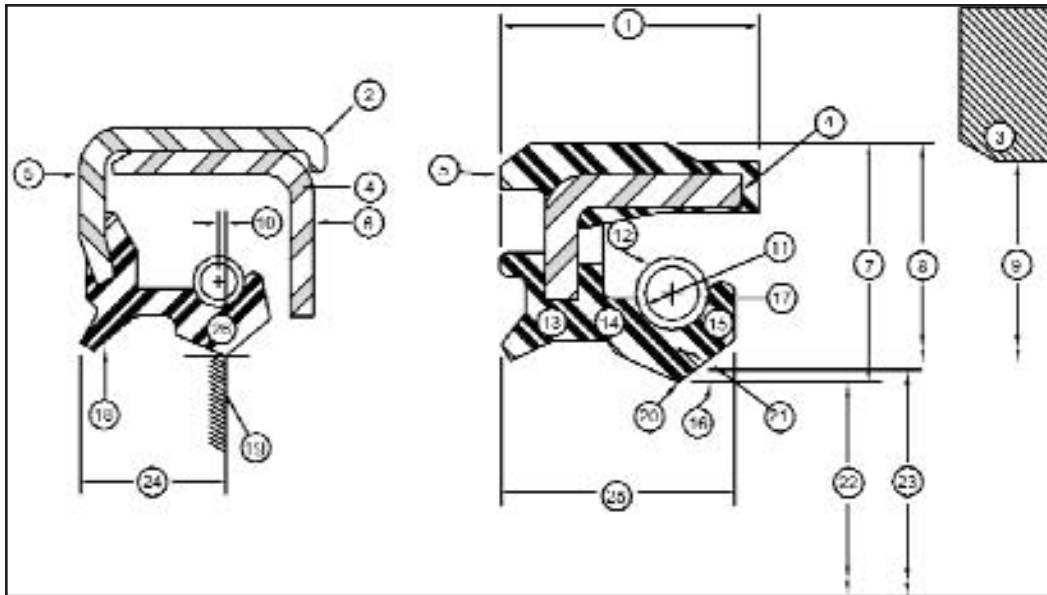

- |     |                           |     |                              |
|-----|---------------------------|-----|------------------------------|
| 1.  | Seal Width                | 14. | Flex Section                 |
| 2.  | Metal Case (Outer)        | 15. | Spring Retainer Lip          |
| 3.  | Housing                   | 16. | Inside Lip Angle             |
| 4.  | Inner Case                | 17. | Toe Face                     |
| 5.  | Outside Face              | 18. | Auxiliary (Dust) Lip         |
| 6.  | Inside Face               | 19. | Rib (Helix)                  |
| 7.  | Radial Wall               | 20. | Contact Point                |
| 8.  | Seal Outer Diameter       | 21. | Inside Lip Surface           |
| 9.  | Housing Bore Diameter     | 22. | Spring Set Lip Diameter      |
| 10. | Spring Position (R-Value) | 23. | Free Lip (Unsprung) Diameter |
| 11. | Spring Groove             | 24. | Contact Line Height          |
| 12. | Garter Spring             | 25. | Lip Height                   |
| 13. | Heel Section              | 26. | Lip Angle                    |

**simrit<sup>®</sup>**



## OPERATING CONDITIONS

### SEAL WITH SPRING Design Limitations

SHAFT DIAMETER	NITRILE LIP MAXIMUM CONTINUOUS SHAFT SPEED	MAXIMUM CONTINUOUS PRESSURE	MAXIMUM TOTAL ECCENTRICITY
General	3,500 rpm	5 psi	0.020"
0.500	7,000 rpm	5 psi	0.004"
1.500	6,000 rpm	5 psi	0.006"
2.500	4,000 rpm	5 psi	0.010"
3.500	3,500 rpm	5 psi	0.013"
4.500	2,600 rpm	5 psi	0.017"

NOTE: Higher shaft speeds possible using higher temperature materials such as polyacrylate, fluoroelastomer or silicone. Slightly higher continuous pressure is possible for shaft speeds below 200 fpm. Higher eccentricity is allowable if shaft speed is reduced.

### SEAL WITHOUT SPRING Design Limitations

SHAFT DIAMETER	MAXIMUM SHAFT SPEED	MAXIMUM CONTINUOUS PRESSURE	MAXIMUM TOTAL ECCENTRICITY
General	2,000 rpm	4 psi	0.005"
0.500	3,500 rpm	4 psi	0.003"
1.500	2,500 rpm	4 psi	0.005"
2.500	2,100 rpm	4 psi	0.006"
3.500	1,500 rpm	4 psi	0.008"
4.500	1,200 rpm	4 psi	0.010"

NOTE: Higher eccentricity is allowable if maximum shaft speed is reduced.

A nonsprung seal design offers a cost effective way to seal high viscosity grease applications. Because the design does not benefit from the constant load of a garter spring, the allowable eccentricity is decreased and the fluids to be sealed are limited.

### ECCENTRICITY

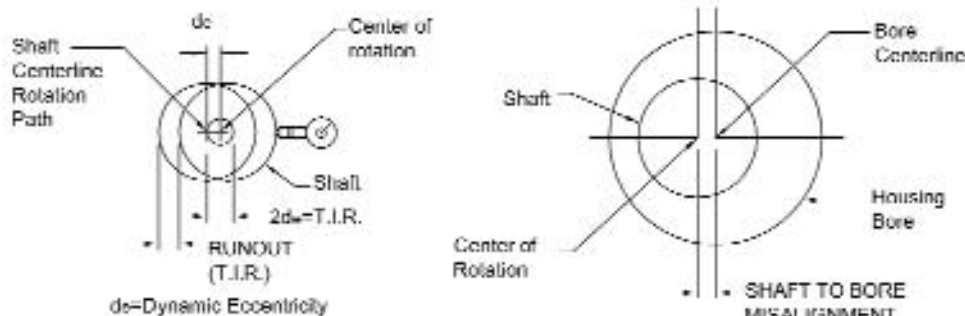

Eccentricity is determined by measuring the shaft run out, TIR and the shaft-to-bore misalignment. Combine the two results for the total eccentricity the seal lip must follow to function effectively. As eccentricity increases, and/or shaft speed increases, it becomes more difficult for the lip to follow the shaft.





## STANDARD MATERIAL PROPERTIES

ASTM/DIN ISO	NBR	ACM	VMQ	FPM (FKM)	HNBR (NEM)	PTFE	FPM*
<b>Wear Resistance</b>	very good	moderate	moderate	very good	moderate	good	very good
<b>High Temperature Oil Resistance</b>	moderate max. 100 C max. 80 C in heavy oil	good max. 150 C	very good max. 180 C	very good max. 200 C (max. 150 C operat.temp.)	good max. 150 C (max 140 C operat.temp.)	good max. 200 C	very good max. 200 C (max. 140 C operat.temp.)
<b>Low Temperature</b>	-40 C	-30 C	-50 C	-25 C	-40 C	-80 C	-10 C
<b>Oil Resistance</b>	good	good	moderate	very good	good	extremely good	extremely good
* special							

## SHAFT RECOMMENDATIONS

### SHAFTS

Seal and shaft compatibility is dependent on four conditions: shaft tolerance, lead-in chamfer, finish and hardness. Proper consideration of these conditions will assist in providing optimal seal performance.

SHAFT HARDNESS is an important factor to prevent excessive wear, deformation, scratches or nicks, and to allow for easy machining for proper roughness. Under normal conditions, the seal contact area of the shaft should be Rockwell C45 minimum.

SHAFT SURFACE ROUGHNESS is very important as this greatly influences the amount of lip wear. The recommended roughness is as follows:

- Rotating 10 to 20  $\mu$  inch Ra (.25  $\mu$ M to .50  $\mu$ M Ra): Rmax = 31 - 126  $\mu$  inch (0.8 - 3.2  $\mu$ M)
- Reciprocating 5 to 10  $\mu$  inch Ra (.13  $\mu$ M to .25  $\mu$ M Ra) The method of achieving this finish should not be overlooked.

Table 6  
**Recommended Shaft Chamfer**

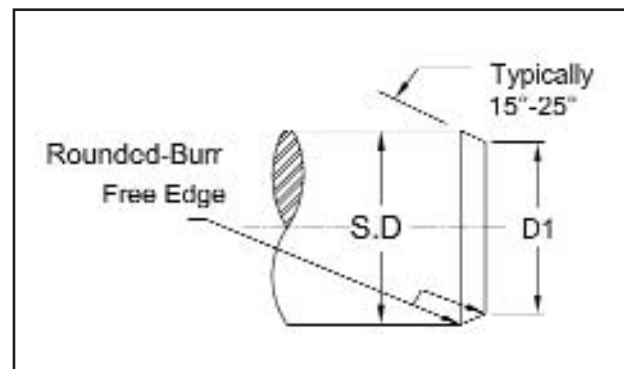

**simrit®**

## SHAFT RECOMMENDATIONS

INCH SIZE  
SHAFT SEALS

**PLUNGE GRINDING** is recommended for rotating shaft applications. For reciprocating applications, centerless grinding is acceptable. Rotating shaft applications require a surface with no machine lead, as machine lead may actually pump fluid from under the seal lip. Also, hard chrome plating is suggested for any cast iron or stainless steel shafts for rotating applications and for steel shafts with reciprocating applications.

**A SHAFT CHAMFER** is suggested to assist in the installation process. Without a proper chamfer, the seal lip may be damaged or distorted resulting in a dislodged garter spring.

**SHAFT TOLERANCE** recommendations for general applications are listed below. The tolerance range should be decreased for high speed or pressure applications.

INCHES	
S.D.	D1
Up to 1.000"	S.D.-0.094
1.001 to 2.000	S.D.-0.140
2.001 to 3.000	S.D.-0.166
3.001 to 4.000	S.D.-0.196
4.001 to 5.000	S.D.-0.220
5.001 to 6.000	S.D.-0.260
6.001 to 7.000	S.D.-0.276
MILLIMETERS	
S.D.	D1
Up to 25.00mm	S.D.-2.40
25.01 to 50.00	S.D.-3.60
50.01 to 75.00	S.D.-4.20
75.01 to 100.00	S.D.-5.00
100.01 to 125.00	S.D.-5.60
125.01 to 150.00	S.D.-6.60
150.01 to 175.00	S.D.-7.00

### Recommended Shaft Tolerance

SHAFT DIAMETER (INCH)	TOLERANCE	SHAFT DIAMETER (DIN/METRIC)	TOLERANCE
Up to 4.000"	±0.003	Up to 100mm	±0.08
4.001 to 6.000	±0.004	100.10 to 150.00	±0.10
6.001 to 10.000	±0.005	150.10 to 250.0	±0.13



## HOUSING RECOMMENDATIONS

### HOUSINGS

Steel and cast iron provide good surfaces for both rubber covered and metal O.D. seals. For soft alloy (aluminum) bores, rubber covered O.D. seals provide better sealing capability. In aluminum or other soft alloy bores, metal O.D. seals occasionally back out of the bore due to the thermal expansion of the soft alloy. Rubber, having a higher coefficient of thermal expansion than carbon steel, will tighten in the bores as temperature rises. Plastic or nylon are not recommended because they typically expand at a high rate causing a major problem for metal O.D. seals. If plastic is to be used, rubber O.D. seals are recommended.

### BORE CHAMFER

A bore chamfer is necessary to assist in installation of the seal. To the right is the recommended configuration for the chamfer.

Proper chamfer angle and depth minimizes cocking or lack of squareness of the seal to the shaft, distortion of the seal cases, and reduces assembly force.

### Recommended Bore Chamfer

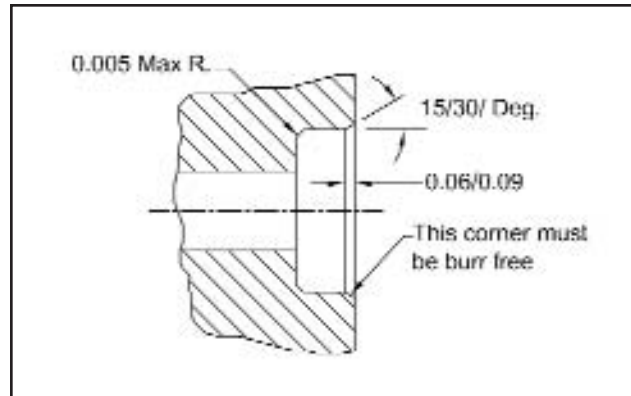

### Surface Roughness

Excessively rough bore finishes may allow paths for fluid to leak between seal O.D. and bore. Below shows the recommended maximum roughness.

	METAL O.D.	RUBBER O.D.
MAXIMUM ROUGHNESS	100 $\mu$ inch Ra 2.50 $\mu$ M Ra	150 $\mu$ inch R <sub>a</sub> 3.75 $\mu$ M R <sub>a</sub>
	492 $\mu$ inch R <sub>max</sub> 12.5 $\mu$ M R <sub>max</sub>	

The rubber O.D. seal is capable of functioning with a rougher finish.

	METAL O.D.	RUBBER O.D.
MINIMUM ROUGHNESS	none	60 $\mu$ inch R <sub>a</sub> 1.5 $\mu$ inch R <sub>a</sub>

A minimum bore roughness is recommended for rubber O.D. seals. This improves retention.

## BORE RECOMMENDATIONS

### BORE DIAMETER TOLERANCE

The recommended housing bore diameter, bore tolerance and nominal pressfit.

#### INCH SIZE

BORE DIAMETER	BORE TOLERANCE	NORMAL PRESSFIT		O.D. TOLERANCE (1)		OUT OF ROUND (2)	
		SEALS WITH METAL O.D.	SEALS. WITH RUBBER O.D.	SEALS WITH METAL O.D.	SEALS. WITH RUBBER O.D.	SEALS WITH METAL O.D.	SEALS WITH RUBBER O.D.
Up to 1.000	±0.001	0.004	0.006	±0.020	±0.030	0.005	0.010
1.001 - 2.000	±0.001	0.004	0.006	±0.020	±0.030	0.006	0.012
2.001 - 3.000	±0.001	0.004	0.006	±0.020	±0.030	0.006	0.014
3.001 - 4.000	±0.0015	0.005	0.008	±0.020	±0.040	0.007	0.018
4.001 - 6.000	±0.0015	0.005	0.010	+0.003 -0.002	±0.040	0.009	0.023
6.001 - 8.000	±0.002	0.006		+0.003 -0.002		0.012	
8.001 - 9.000	±0.002	0.007		+0.004 -0.002		0.015	
9.001 - 10.000	±0.002	0.008		+0.004 -0.002		0.015	

#### EQUIVALENT METRIC SIZE

BORE DIAMETER	BORE TOLERANCE	NORMAL PRESSFIT		O.D. TOLERANCE (1)		OUT OF ROUND (2)	
		SEALS WITH METAL O.D.	SEALS. WITH RUBBER O.D.	SEALS WITH METAL O.D.	SEALS. WITH RUBBER O.D.	SEALS WITH METAL O.D.	SEALS WITH RUBBER O.D.
Up to 25.00	±0.025	0.10	0.15	±0.05	±0.08	0.13	0.25
25.01 - 50.00	±0.025	0.10	0.15	±0.05	±0.08	0.15	0.30
50.01 - 75.00	±0.025	0.10	0.15	±0.05	±0.08	0.15	0.36
75.01 - 100.00	±0.038	0.13	0.20	±0.05	±0.10	0.18	0.46
100.01 - 150.00	±0.038	0.13	0.25	+0.08 -0.05	±0.10	0.23	0.58
150.01 - 200.00	±0.051	0.15		+0.08 -0.05		0.30	
200.01 - 225.00	±0.051	0.18		+0.10 -0.05		0.38	
225.01 - 250.00	±0.051	0.20		+0.10 -0.05		0.38	











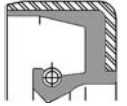
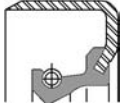
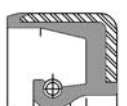

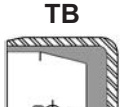
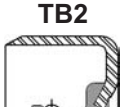
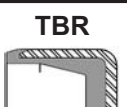
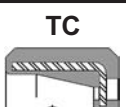
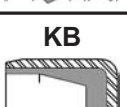

INCH SIZE  
SHAFT SEALS

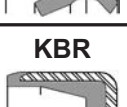
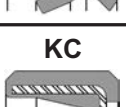

## RADIAL SHAFT SEALS - NBR/STEEL

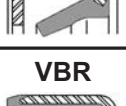
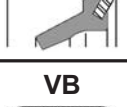
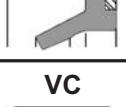
## NOK AVAILABILITY LIST

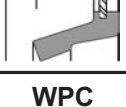
NOK Ref.	Dimensions			Design Type	NOK Ref.	Dimensions			Design Type	SB	
	d	D	H			d	D	H		SB2	SB2
AB0103-E0	0.131	0.500	0.125	VC	AD0913-F0	0.750	1.250	0.252	TB2		
AG6900-E0	0.181	0.750	0.299	KC	AE0913-E0	0.750	1.250	0.252	TC		
UG0515-E0	0.250	0.500	0.126	VC	AB0923-H0	0.750	1.375	0.252	SB		
AC6753-E0	0.312	0.625	0.157	SC	AP0923-E0	0.750	1.375	0.252	TB		
AC0105-E0	0.313	0.750	0.252	SC	AD0923-F0	0.750	1.375	0.252	TB2		
AC0105-H0	0.313	0.750	0.252	SC	ACC154-A0	0.750	1.375	0.311	SC		
AF0222-E0	0.375	0.687	0.157	VB	BF1341-E0	0.750	1.388	0.126	VB		
AB0224-G0	0.375	0.750	0.252	SB	AB7761-E0	0.750	1.499	0.252	SB2		
ACC341-A0	0.375	0.750	0.252	SC	AD7761-E0	0.750	1.500	0.250	TB2		
AC0227-E0	0.375	0.875	0.311	SC	AE7698-E0	0.750	1.575	0.311	TC		
AD0325-F0	0.437	0.875	0.252	TB	AB7762-E0	0.750	1.624	0.252	SB2		
AF0437-F0	0.500	0.750	0.126	VB	AD8948-F0	0.750	1.874	0.252	TB2		
AG0433-H0	0.500	0.687	0.094	VC	AB8779-E0	0.781	1.375	0.311	SB2		
AF0438-E0	0.500	0.751	0.126	VB	AE0948-E0	0.781	1.850	0.374	TC		
AE0442-G0	0.500	0.875	0.252	TC	AC1070-E0	0.813	1.250	0.390	SC		
AB8497-E0	0.500	0.875	0.311	SB	AD6942-E0	0.813	1.375	0.252	TB		
AB7758-E0	0.500	0.999	0.252	SB	UB0017-E0	0.813	1.375	0.374	SB2		
ACC364-A0	0.500	1.000	0.252	SC	AFF492-A0	0.875	1.125	0.118	VB		
AB0456-F0	0.500	1.124	0.252	SB	AB1172-E0	0.875	1.250	0.189	SB		
AB0456-G0	0.500	1.124	0.252	SB2	AB1172-E1	0.875	1.250	0.189	SB		
AB7759-E0	0.500	1.250	0.252	SB	AB1181-F0	0.875	1.375	0.252	SB2		
AB0462-E0	0.500	1.375	0.311	SB2	AP1181-E0	0.875	1.375	0.252	TB		
AF0544-E0	0.562	0.999	0.220	VB	AF1181-E0	0.875	1.375	0.252	VB		
UB0034-E0	0.563	0.875	0.189	SB	AB7763-E0	0.875	1.499	0.252	SB2		
AD7709-E0	0.563	1.125	0.252	TB	ADD326-A0	0.875	1.500	0.311	TB		
AD0645-G0	0.625	1.124	0.250	TB	AB1194-E0	0.875	1.624	0.252	SB2		
AD0657-E0	0.625	1.375	0.252	TB	AD1198-F0	0.875	1.875	0.252	TB		
AF7554-E0	0.625	0.813	0.094	VB	AD1181-I0	0.875	1.375	0.252	TB2		
AF0636-E0	0.625	0.937	0.189	VB	BB0117-E0	0.937	1.828	0.437	SB		
AC0639-E0	0.625	0.999	0.252	SC	AB1232-E0	0.937	1.499	0.252	SB2		
AF8782-E0	0.625	1.000	0.126	VB	AD7647-E0	0.937	1.750	0.311	TB2		
AE8004-E0	0.625	1.000	0.252	TC	UD0461-E0	0.942	1.496	0.252	TB		
AB0645-F0	0.625	1.124	0.252	SB	AA7203-E0	0.969	1.499	0.500	TA		
AG0645-E0	0.625	1.124	0.252	VC	AB1274-E0	0.969	1.624	0.311	SB		
AC0649-E0	0.625	1.125	0.252	SC	AB1274-F0	0.969	1.624	0.311	SB2		
AB0654-E0	0.625	1.250	0.252	SB	UE0323-E0	0.969	2.048	0.374	TC		
AB0657-E0	0.625	1.375	0.252	SB	AP6994-E0	0.997	1.750	0.374	TB		
BF2796-E0	0.625	0.816	0.094	VB	BF2798-E0	1.000	1.254	0.109	VB		
UE0319-E0	0.656	1.575	0.252	TC	AR1432-E0	1.000	1.624	0.374	TB4		
AD7111-E1	0.687	1.250	0.252	TB2	AG1399-E0	1.000	1.250	0.126	VC		
AP0786-E0	0.687	1.124	0.252	TB	AF8521-E0	1.000	1.312	0.126	VB		
AF7027-E0	0.687	1.375	0.118	VB	AB1402-E0	1.000	1.375	0.189	SB		
AFF901-A0	0.750	1.000	0.126	VB	AF1402-F1	1.000	1.375	0.189	VB		
AF0888-F0	0.750	1.000	0.126	VB	AB1403-E0	1.000	1.375	0.252	SB2		
AB0898-E0	0.750	1.125	0.189	SB	AB1403-E1	1.000	1.375	0.252	SB2		
AC0898-E0	0.750	1.125	0.189	SC	AD1407-E0	1.000	1.437	0.311	TB		
ABB515-A0	0.750	1.250	0.189	SB2	AB1408-E0	1.000	1.437	0.252	SB		
AB0913-F0	0.750	1.250	0.252	SB2	AB1410-F0	1.000	1.499	0.252	SB2		

N.B.: MINIMUM LINE ORDER MAY APPLY

## NOK AVAILABILITY LIST

## RADIAL SHAFT SEALS - NBR/STEEL

**INCH SIZE  
SHAFT SEALS**

SB	SB2	NOK Ref.	Dimensions			Design Type	NOK Ref.	Dimensions			Design Type
			d	D	H			d	D	H	
		UP0119-E0	1.000	1.499	0.252	TCV	ADD804-A0	1.250	1.752	0.252	TB2
		AD1410-H0	1.000	1.500	0.250	TB2	AD1826-E0	1.250	1.752	0.252	TB2
<b>SBR</b>	<b>SC</b>	AB7659-E0	1.000	1.625	0.252	SB2	AF1826-E0	1.250	1.752	0.252	VB2
		AB7765-E0	1.000	1.752	0.252	SB2	AB1832-F1	1.250	1.874	0.252	SB2
		AD7765-E0	1.000	1.752	0.252	TB2	AD1832-E0	1.250	1.874	0.252	TB2
		AF7604-E0	1.000	1.781	0.469	VB2	AF1836-F1	1.250	1.979	0.252	VB2
<b>SA2</b>	<b>TA2</b>	AA7681-E0	1.000	1.828	0.295	SA2	AF1837-E0	1.250	1.979	0.406	VB2Y
		AB6922-E0	1.000	1.874	0.252	SB	AB7128-E0	1.250	1.983	0.252	SB2
		UE0112-E0	1.000	1.983	0.311	TC	UF0476-E0	1.250	1.983	0.252	VB2Y
		AD1446-E0	1.000	2.000	0.250	TB2	AB1838-E0	1.250	2.000	0.252	SB2
		AC1446-F0	1.000	2.000	0.252	SC	AC1838-E0	1.250	2.000	0.252	SC
		AA8056-E0	1.000	2.062	0.374	SA2	AD1838-E0	1.250	2.000	0.252	TB2
<b>TB</b>	<b>TB2</b>	BB0150-E0	1.063	1.750	0.437	SB2	AB7127-E0	1.250	2.125	0.252	SB2
		AC8471-E0	1.063	1.498	0.252	SC	UE0136-E0	1.250	2.374	0.311	TC
		AB8071-E0	1.063	1.624	0.437	SB2	AE7705-E0	1.250	2.835	0.374	TC
		AD1617-F0	1.125	2.000	0.252	TB2	AD7772-E0	1.313	2.125	0.311	TB2
<b>TBR</b>	<b>TC</b>	AF1588-F0	1.125	1.375	0.126	VB	AB6819-E0	1.375	1.749	0.189	SB
		AF1591-E0	1.125	1.499	0.189	VB2	AC8559-E0	1.375	1.828	0.252	SC
		AB7375-E0	1.125	1.563	0.252	SB2	AB8202-E1	1.375	1.874	0.311	SB
		AB1598-E0	1.125	1.624	0.252	SB2	AF8522-E0	1.375	1.938	0.252	VB2
		ACC769-A0	1.125	1.624	0.252	SC	ADD347-A1	1.375	2.000	0.311	TB2
<b>KB</b>	<b>KB2</b>	AD1598-F1	1.125	1.624	0.252	TB2	AC2007-E0	1.375	2.062	0.374	SC
		AB7766-E0	1.125	1.752	0.252	SB2	AB7775-E0	1.375	2.250	0.311	SB2
		AF8374-E0	1.125	1.781	0.252	VB2	AD7775-E0	1.375	2.250	0.311	TB2
		AF7103-E0	1.125	1.781	0.469	VB2Y	AC2016-F1	1.375	2.250	0.500	SC
<b>KBR</b>	<b>KC</b>	AB1610-E0	1.125	1.828	0.311	SB	AB7776-E0	1.375	2.374	0.311	SB2
		AE7694-E0	1.125	1.850	0.311	TC	AA7323-E0	1.375	2.437	0.469	TA2
		AB7767-E0	1.125	1.874	0.252	SB2	AD7708-E0	1.375	2.441	0.311	TB2
		AD7767-E0	1.125	1.874	0.252	TB2	AE7708-E0	1.375	2.441	0.311	TC
		AF1616-E0	1.125	1.938	0.343	VB2	AB8523-E0	1.375	2.561	0.374	SB2
<b>KA2</b>	<b>VA2</b>	AB1617-E0	1.125	2.000	0.252	SB2	AE2022-E0	1.375	2.717	0.374	TC
		AD8377-E0	1.125	2.125	0.437	TB2	AE7126-E0	1.375	2.835	0.311	TC
		AE7145-E1	1.125	2.441	0.311	TC	AD7175-E0	1.375	2.125	0.311	TB2
		AD1623-E0	1.126	1.693	0.250	TB2	AH8563-F0	1.399	2.292	0.500	HSBY
<b>VB2</b>	<b>VBR</b>	AD8236-E0	1.156	1.875	0.374	TB2	AD7777-E0	1.437	2.125	0.313	TB2
		AD7268-E0	1.156	2.000	0.311	TB2	BB0230-E0	1.437	2.437	0.469	SB2
		AE7150-E0	1.156	2.062	0.252	TC	AB7777-E0	1.437	2.125	0.311	SB2
		AD7666-E0	1.156	2.062	0.374	TB2	AB7778-E0	1.437	2.250	0.311	SB2
		AA7075-E0	1.187	1.686	0.252	SA2	AB7779-E0	1.437	2.374	0.311	SB2
<b>VB</b>	<b>VC</b>	AB7769-E0	1.187	1.874	0.252	SB2	AB7780-E0	1.437	2.502	0.311	SB2
		AB1779-E0	1.187	2.000	0.252	SB2	UB0498-E0	1.500	1.874	0.252	SB2
		AB1783-E0	1.187	2.062	0.437	SB2	AB2263-E0	1.500	1.875	0.189	SB
		UB0084-E0	1.188	2.438	0.252	SB2	AFF912-A0	1.500	1.875	0.189	VB
		AF1789-E0	1.219	1.979	0.406	VB2	AF2264-E0	1.500	1.875	0.252	VB
<b>WPB</b>	<b>WPC</b>	AC7126-E0	1.240	1.686	0.250	SC	AR2266-F0	1.500	1.983	0.189	VB
		AF7936-E0	1.250	1.686	0.252	VB	BF1161-E0	1.500	1.989	0.252	KB
		ABB512-A0	1.250	1.689	0.252	SB2	AB7368-E0	1.500	2.000	0.311	SB2
		AD1826-E0	1.250	1.752	0.252	SB2	AB7781-E0	1.500	2.125	0.311	SB2

N.B.: MINIMUM LINE ORDER MAY APPLY

Tel.: (418) 688-3202  
Fax: (418) 688-4272

**SS 13**

[www.sealsonline.com](http://www.sealsonline.com)





## RADIAL SHAFT SEALS - NBR/STEEL

## NOK AVAILABILITY LIST

NOK Ref.	Dimensions			Design Type	NOK Ref.	Dimensions			Design Type	SB	SB2
	d	D	H			d	D	H			
AB7860-E0	1.500	2.250	0.311	SB2	AB2600-E0	1.750	2.875	0.252	SB2		
AD7860-E0	1.500	2.250	0.311	TB2	AP6842-E0	1.750	2.998	0.374	SA2		
UF0018-E0	1.500	2.254	0.252	VB2	AD8527-E0	1.750	3.061	0.500	TB2		
AF2285-G0	1.500	2.328	0.406	VB2Y	AF8933-E0	1.875	2.401	0.272	VB2		
AB7782-E0	1.500	2.374	0.311	SB2	AB7798-E0	1.875	2.623	0.311	SB2		
AD7782-E0	1.500	2.374	0.311	TB2	AB7799-E0	1.875	2.750	0.311	SB2		
AA2291-E0	1.500	2.441	0.469	SA2	AB7800-E0	1.875	2.875	0.311	SB2		
AD7783-E0	1.500	2.502	0.311	TB2	AB7801-E0	1.875	3.000	0.311	SB2		
AF8495-E0	1.500	2.623	0.252	VB2Y	UF0200-E0	1.937	2.622	0.260	KB9		
AC2296-E0	1.500	2.750	0.374	SC	AD7803-E0	1.937	2.623	0.311	TB2		
UD0173-E0	1.550	2.690	0.500	TB2	AB7804-E0	1.937	2.750	0.311	SB2		
AA7601-E0	1.563	2.125	0.437	TA2	AB7805-E0	1.937	2.875	0.311	SB2		
AB7785-E0	1.563	2.374	0.311	SB2	AB7806-E0	1.937	3.000	0.311	SB2		
AD7877-E0	1.563	2.437	0.374	TB2	UF0038-F0	1.938	2.502	0.280	KB5Y		
AB7786-E0	1.563	2.502	0.311	SB2	ACC784-A0	2.000	2.502	0.252	SC		
AD2323-E0	1.563	2.875	0.469	TB2	UD0154-E0	2.000	2.502	0.252	TB2		
AE7676-E0	1.563	3.150	0.311	TC	UF0225-E0	2.000	2.562	0.220	VB2Y		
ABB544-A0	1.625	2.000	0.189	SB	UB0218-E0	2.000	2.565	0.331	SB5Y		
AD7788-E0	1.625	2.250	0.311	TB2	UF0195-E0	2.000	2.623	0.252	KB5Y		
AF2458-F0	1.625	2.328	0.437	VB2Y	UF0213-E0	2.000	2.624	0.252	KB2		
AB2459-E0	1.625	2.374	0.311	SB2	AE6873-E0	2.000	2.717	0.563	TC		
AA8765-E0	1.625	2.437	0.374	TA2	UD0241-E0	2.000	2.742	0.374	TB2		
UB0646-E0	1.625	2.441	0.311	SB2	AA7325-E0	2.000	2.750	0.252	VA		
AB7789-E0	1.625	2.502	0.311	SB2	AB2919-E0	2.000	2.750	0.311	SB2		
AD7789-E0	1.625	2.502	0.311	TB2	AB7807-E0	2.000	2.875	0.311	SB2		
AF7276-E0	1.625	2.562	0.252	VBY	AA2928-E0	2.000	2.995	0.500	TA2		
AB7790-E0	1.625	2.623	0.311	SB2	AB7940-E0	2.000	2.997	0.374	SB2		
AD7667-E0	1.687	2.835	0.500	TB2	AD2931-F0	2.000	3.000	0.311	TB2		
UF0217-E0	1.687	2.328	0.280	KBY	AD7808-E0	2.000	3.125	0.311	TB2		
AF2533-E0	1.687	2.502	0.280	VB2	BF1060-E0	2.000	3.623	0.252	VB2Y		
AD6858-E0	1.687	2.502	0.374	TB2	UF0219-E0	2.048	2.728	0.252	KB9		
UH0246-E0	1.687	2.557	0.465	HTCY	UF0216-E0	2.062	3.000	0.311	KB2		
AF2535-E0	1.687	2.623	0.374	VB2	AC2980-E0	2.063	2.875	0.374	SC		
AD6789-E0	1.687	2.623	0.500	TB2	UD0075-E0	2.063	3.000	0.311	TB2		
UF0230-E0	1.730	2.336	0.252	KB9	AF8224-E0	2.094	2.716	0.358	VB2		
UF0260-E0	1.730	2.401	0.240	VB2Y	AF2993-F0	2.125	2.875	0.252	VB2		
AB2573-E0	1.750	2.125	0.189	SB	AF8389-E0	2.125	3.000	0.311	KB2		
AF2573-F0	1.750	2.125	0.189	VB	AB7810-E0	2.125	3.000	0.374	SB2		
AC2576-F0	1.750	2.250	0.311	SC	AD7811-E0	2.125	3.125	0.374	TB2		
UB0086-E0	1.750	2.250	0.414	SB	AD3005-F0	2.125	3.189	0.469	TB2		
AB7795-E0	1.750	2.374	0.311	SB2	BFF953-A0	2.180	3.000	0.500	KB2		
UB0368-E0	1.750	2.438	0.311	SB2	AD7816-E0	2.187	3.251	0.374	TB2		
UF0719-E0	1.750	2.502	0.252	VB2Y	AB7153-E0	2.250	3.000	0.374	SB2		
AB7095-E0	1.750	2.502	0.311	SB2	UF0067-E0	2.250	3.251	0.252	VB2Y		
AB7796-E0	1.750	2.623	0.311	SB2	AB7817-E0	2.250	3.251	0.374	SB2		
AB7686-E0	1.750	2.686	0.374	SB2	AA3132-G0	2.250	3.350	0.469	SA2		
AF8057-E0	1.750	2.718	0.358	VB2Y	AB3135-E0	2.250	3.371	0.374	SB2		
AB7797-E0	1.750	2.750	0.311	SB2	AA8531-E0	2.250	3.623	0.469	SA2		

N.B.: MINIMUM LINE ORDER MAY APPLY

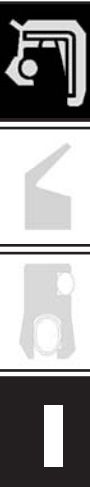

## NOK AVAILABILITY LIST

## RADIAL SHAFT SEALS - NBR/STEEL

SB	SB2	NOK Ref.	Dimensions			Design Type	NOK Ref.	Dimensions			Design Type
			d	D	H			d	D	H	
		AB3129-F0	2.250	3.371	0.374	SB2	AA7411-E0	3.187	4.249	0.469	SA2
		AE3138-E0	2.250	3.500	0.500	TC	AA7412-E0	3.250	4.249	0.469	TA2
		AD3167-E0	2.313	3.125	0.374	TB	AD7836-E0	3.250	4.376	0.500	TB2
<b>SBR</b>	<b>SC</b>	AB3169-E0	2.313	3.251	0.500	SB	AB3809-E0	3.250	4.500	0.500	SB2
		UB0142-E0	2.328	3.000	0.374	SB2	AB7837-E0	3.250	4.626	0.500	SB2
		AB3253-E0	2.375	3.125	0.374	SB2	AA3794-Z1	3.250	4.000	0.500	SA
		AD7818-E0	2.375	3.251	0.374	TB2	BB0525-E0	3.250	4.748	0.500	SB2
<b>SA2</b>	<b>TA2</b>	AB7738-E0	2.375	3.256	0.437	SB2	AB7839-E0	3.375	4.376	0.500	SB2
		AA3257-E0	2.375	3.350	0.469	TA2	AB7840-E0	3.375	4.500	0.500	SB2
		AB7819-E0	2.375	3.371	0.374	SB2	AB7841-E0	3.375	4.626	0.500	SB2
		AA3262-E0	2.375	3.483	0.500	TA2	AB3874-E1	3.437	4.500	0.469	SB
		AB7820-E0	2.375	3.500	0.374	SB2	AA8223-E0	3.438	4.756	0.563	SA2
<b>TB</b>	<b>TB2</b>	AD7820-E0	2.375	3.500	0.374	TB2	AC3888-E0	3.500	4.375	0.374	SC
		AA3267-F0	2.375	3.623	0.358	SA2	AB3891-F0	3.500	4.500	0.500	SB2
		UB0658-E0	2.438	3.350	0.374	SB2	AB7844-E0	3.500	4.750	0.500	SB2
		AB3338-E0	2.500	3.251	0.374	SB2	BC0595-E0	3.500	4.996	0.500	SC
<b>TBR</b>	<b>TC</b>	AD3338-E0	2.500	3.251	0.374	TB2	AB7845-E0	3.625	4.626	0.500	SB2
		UH0214-E0	2.500	3.297	0.327	HTBIY	AB3963-E0	3.625	4.750	0.500	SB2
		AB3347-F0	2.500	3.500	0.374	SB2	AD7846-E0	3.625	4.875	0.500	TB2
		AA3349-E0	2.500	3.500	0.500	TA2	AD7847-E0	3.625	4.999	0.500	TB2
		AD7079-F0	2.500	3.623	0.374	TB2	UA0080-E0	3.750	4.500	0.469	TA2
<b>KB</b>	<b>KB2</b>	UA0220-E0	2.625	3.371	0.437	TA2	AD4017-E0	3.750	4.750	0.500	TB2
		AB7824-E0	2.625	3.623	0.374	SB2	AB4020-E0	3.750	4.999	0.500	SB2
		ADD864-A0	2.625	3.623	0.374	TB2	AB4023-X0	3.750	5.248	0.626	SB2
		AD7824-E0	2.625	3.623	0.374	TB2	AB7850-E0	3.875	4.875	0.500	SB2
<b>KBR</b>	<b>KC</b>	BB0461-E0	2.625	3.375	0.374	SB2	AD4037-E0	3.875	4.999	0.500	TB2
		AB3478-F0	2.750	3.500	0.374	SB2	AB7851-E0	3.875	5.125	0.500	SB2
		AB7827-E0	2.750	3.751	0.374	SB2	AD7852-E0	3.875	5.250	0.500	TB2
		UA0029-E0	2.750	3.876	0.438	SA2	UA0078-E0	3.875	5.375	0.437	SA2
		AB3487-E0	2.750	4.249	0.626	SB2	UA0071-E0	3.875	5.690	0.626	SA2
<b>KA2</b>	<b>VA2</b>	UZ0212-E0	2.875	3.875	0.409	HTBIY	AB4122-X0	4.000	5.500	0.563	SB2
		AB7830-E0	2.875	3.876	0.374	SB2	AB4109-E0	4.000	4.999	0.500	SB2
		BB0504-E0	2.937	3.751	0.500	SB2	AB4116-F0	4.000	5.125	0.500	SB2
		AD3589-E0	2.937	4.000	0.437	TB2	AB7853-E0	4.000	5.250	0.500	SB2
		BB1853-E0	2.938	3.756	0.500	SB2	AB7854-E0	4.000	5.375	0.500	SB2
<b>VB2</b>	<b>VBR</b>	AE9158-E0	3.000	3.750	0.437	TC	UA0074-E0	4.000	5.625	0.437	SA2
		AD3673-E0	3.000	4.248	0.626	TB2	AD7855-E0	4.250	5.250	0.500	TB2
		AB7831-E0	3.000	3.751	0.437	SB2	AB4180-E0	4.250	5.375	0.500	SB2
		AB7832-E0	3.000	3.876	0.437	SB2	AB4228-E0	4.374	5.500	0.563	SB2
		AB3664-E0	3.000	4.003	0.437	SB2	AD9109-E0	4.437	5.500	0.563	TB2
<b>VB</b>	<b>VC</b>	AB3665-E0	3.000	4.003	0.469	SB2	UA0073-E0	4.500	5.375	0.437	SA2
		UA0085-E0	3.000	4.999	0.437	SA2	AB4255-F0	4.500	5.500	0.500	SB2
		AD3704-E0	3.125	4.000	0.437	TB2	AD4262-E0	4.500	5.750	0.500	TB2
		AD3706-F0	3.125	4.122	0.563	TB	AB4306-E1	4.622	5.748	0.563	SB
<b>WPB</b>	<b>WPC</b>	AF8542-E0	3.125	4.125	0.236	KB2	AD4370-E0	4.748	6.248	0.563	TB2
		AB3705-E0	3.125	4.125	0.500	SB2	AD4362-E0	4.750	5.750	0.500	TB2
		AD3708-E0	3.125	4.249	0.500	TB2	AB7858-E0	4.750	6.001	0.500	SB2
		AB7835-E0	3.125	4.500	0.500	SB2	AB4413-E2	4.937	6.248	0.563	SB

N.B.: MINIMUM LINE ORDER MAY APPLY





# GLOBAL AVAILABILITY NBR/STEEL



INCH SIZE  
SHAFT SEALS

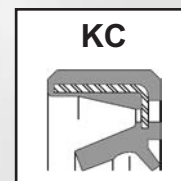
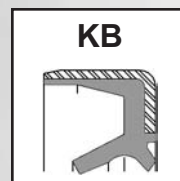
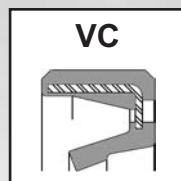
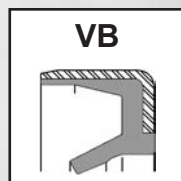
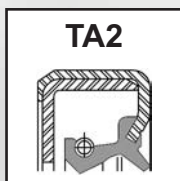
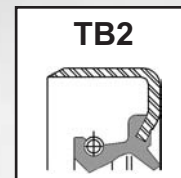
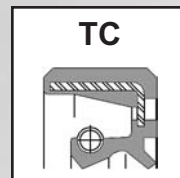
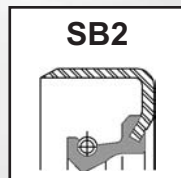
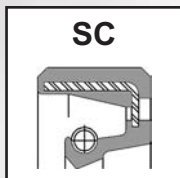

## RADIAL SHAFT SEALS - NBR/STEEL

## GLOBAL AVAILABILITY LIST

Ref. Number	Dimensions			DESIGN TYPE										SC
	d	D	H	SC	SB2	SA2	TC	TB2	TA2	VB	VC	KB	KC	
S0012500500-158	0.125	0.500	0.158	*	*	*	*	*	*	*	*	*	X	
S0012500500-250	0.125	0.500	0.250	*	*	*	*	*	*	*	*	*	X	
S0015700500-158	0.157	0.500	0.158	*	*	*	*	*	*	*	*	*	X	
S0018700750-250	0.187	0.750	0.250	*	*	*	*	X	*	*	*	*	*	
S0025000500-125	0.250	0.500	0.125	*	*	*	*	*	*	*	*	*	X	
S0031200500-125	0.312	0.500	0.125	*	*	*	*	*	*	*	*	*	X	
S0031200625-157	0.312	0.625	0.157	*	*	*	*	X	*	*	*	*	*	
S0031200687-250	0.312	0.687	0.250	*	*	*	*	X	*	*	*	*	*	
S0031200865-250	0.312	0.865	0.250	*	*	*	*	X	*	*	*	*	*	
S0031200999-375	0.312	0.999	0.375	*	*	*	*	*	*	X	*	*	*	
S0031300999-313	0.313	0.999	0.313	*	*	*	*	*	*	*	X	*	*	
S0032700500-125	0.327	0.500	0.125	*	*	*	*	*	*	*	*	*	X	
S0037500562-094	0.375	0.562	0.094	*	*	*	*	*	*	*	*	X	*	
S0037500562-125	0.375	0.562	0.125	*	*	*	*	*	*	*	*	*	X	
S0037500750-250	0.375	0.750	0.250	*	*	*	X	X	*	*	X	*	*	
S0037500819-250	0.375	0.819	0.250	*	*	*	*	X	*	*	*	*	*	
S0037500836-187	0.375	0.836	0.187	*	*	*	*	*	*	X	*	*	*	
S0037500875-250	0.375	0.875	0.250	*	*	*	*	X	*	X	*	*	*	
S0037500938-188	0.375	0.938	0.188	*	*	*	*	*	*	*	*	X	*	
S0037501124-250	0.375	1.124	0.250	*	*	*	*	X	*	*	*	*	*	
S0040900789-197	0.409	0.789	0.197	*	*	*	*	*	*	*	*	*	X	
S0043400999-250	0.434	0.999	0.250	*	*	*	*	*	*	*	X	*	*	
S0043700624-125	0.437	0.624	0.125	*	*	*	*	*	*	*	*	*	X	
S0043800877-250	0.438	0.877	0.250	*	*	*	*	X	*	*	*	*	*	
S0043800999-375	0.438	0.999	0.375	*	*	*	X	*	*	*	*	*	*	
S0046801124-375	0.468	1.124	0.375	*	*	*	*	*	*	X	*	*	*	
S0050000687-093	0.500	0.687	0.093	*	*	*	*	*	*	*	*	*	X	
S0050000688-094	0.500	0.688	0.094	*	*	*	*	*	*	*	*	*	X	
S0050000749-165	0.500	0.749	0.165	*	*	*	*	*	*	*	X	*	*	
S0050000843-250	0.500	0.843	0.250	*	*	*	*	*	*	*	*	X	*	
S0050000875-125	0.500	0.875	0.125	*	*	*	*	*	*	*	*	*	X	
S0050000875-250	0.500	0.875	0.250	*	*	*	*	X	*	X	X	X	*	
S0050000999-250	0.500	0.999	0.250	*	*	*	X	*	*	X	X	*	*	
S0050001000-250	0.500	1.000	0.250	*	*	*	*	*	*	*	X	*	*	
S0050001124-250	0.500	1.124	0.250	*	*	*	X	X	*	X	*	*	*	
S0050001250-250	0.500	1.250	0.250	*	*	*	X	*	*	*	X	*	*	
S0050001375-250	0.500	1.375	0.250	*	*	*	X	*	*	X	*	*	*	
S0050001750-125	0.500	1.750	0.125	*	*	*	*	*	*	*	*	X	*	
S0051500751-125	0.515	0.751	0.125	*	*	*	*	*	*	*	*	*	X	
S0051500875-125	0.515	0.875	0.125	*	*	*	*	*	*	*	*	*	X	
S0053101124-312	0.531	1.124	0.312	*	*	*	*	*	*	X	*	*	*	
S0056200875-187	0.562	0.875	0.187	*	*	*	*	*	*	*	X	*	*	
S0056200999-250	0.562	0.999	0.250	*	*	*	*	*	*	*	X	*	*	
S0056201124-343	0.562	1.124	0.343	*	*	X	*	*	*	*	*	*	*	
S0056201250-250	0.562	1.250	0.250	*	*	*	*	*	*	X	*	*	*	
S0056201375-250	0.562	1.375	0.250	*	*	*	*	*	*	X	*	*	*	
S0056201375-406	0.562	1.375	0.406	*	*	*	*	*	X	*	*	*	*	
S0056300999-250	0.563	0.999	0.250	*	*	*	X	*	*	*	*	*	*	

X: EXISTING TOOLING \* : ON REQUEST



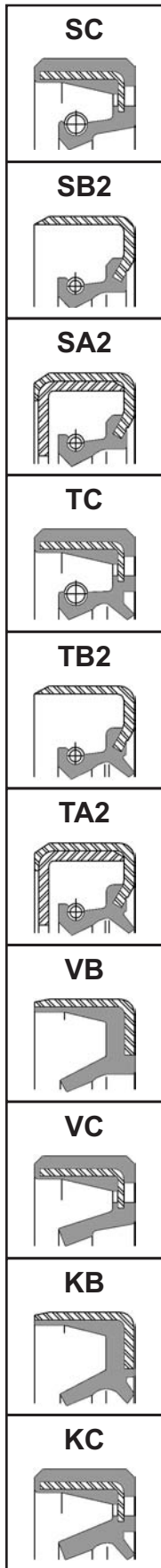







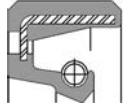
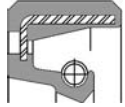





N.B.: MINIMUM LINE ORDER MAY APPLY



## GLOBAL AVAILABILITY LIST

## RADIAL SHAFT SEALS - NBR/STEEL

INCH SIZE  
SHAFT SEALS

SC 	Ref. Number	Dimensions			DESIGN TYPE									
		d	D	H	SC	SB2	SA2	TC	TB2	TA2	VB	VC	KB	KC
	S0056301124-250	0.563	1.124	0.250	•	•	•	•	•	•	X	•	•	•
	S0059001125-313	0.590	1.125	0.313	•	•	•	•	X	•	•	X	•	•
	S0059300935-175	0.593	0.935	0.175	•	•	•	•	•	•	•	•	•	X
	S0059301124-312	0.593	1.124	0.312	•	•	•	•	•	•	X	•	•	•
	S0059301250-312	0.593	1.250	0.312	•	•	•	•	•	•	X	•	•	•
	S0059301375-312	0.593	1.375	0.312	•	•	•	•	•	•	X	•	•	•
	S0059401124-250	0.594	1.124	0.250	•	•	•	•	•	•	•	•	X	•
	S0062500812-125	0.625	0.812	0.125	•	•	•	•	•	•	•	•	•	X
	S0062500813-094	0.625	0.813	0.094	•	•	•	•	•	•	•	•	•	X
	S0062500875-094	0.625	0.875	0.094	•	•	•	•	•	•	•	•	•	X
	S0062500876-125	0.625	0.876	0.125	•	•	•	•	•	•	•	•	•	X
	S0062500933-188	0.625	0.933	0.188	•	•	•	•	•	•	•	•	X	•
	S0062500938-188	0.625	0.938	0.188	•	•	•	•	•	•	•	•	X	•
	S0062500999-250	0.625	0.999	0.250	•	•	•	X	•	•	X	X	X	•
	S0062501000-250	0.625	1.000	0.250	•	•	•	•	•	•	•	X	•	•
	S0062501124-250	0.625	1.124	0.250	•	•	•	X	•	•	X	•	•	•
	S0062501124-375	0.625	1.124	0.375	•	•	•	X	•	X	•	X	•	•
	S0062501125-250	0.625	1.125	0.250	•	•	•	•	X	•	•	X	•	•
	S0062501125-312	0.625	1.125	0.312	•	•	•	•	X	•	•	•	•	•
	S0062501250-250	0.625	1.250	0.250	•	•	•	•	•	•	X	X	•	•
	S0062501375-250	0.625	1.375	0.250	•	•	•	X	•	•	X	X	X	•
	S0062501375-312	0.625	1.375	0.312	•	•	•	•	•	X	•	•	•	•
	S0062501377-250	0.625	1.377	0.250	•	•	•	•	•	X	•	•	•	•
	S0062501377-406	0.625	1.377	0.406	•	•	X	•	•	•	•	•	•	•
	S0062501499-250	0.625	1.499	0.250	•	•	•	X	•	•	X	X	•	•
	S0062501561-250	0.625	1.561	0.250	•	•	•	•	•	•	X	•	•	•
	S0062501624-312	0.625	1.624	0.312	•	•	•	•	•	•	X	•	•	•
	S0065601124-250	0.656	1.124	0.250	•	•	•	X	•	•	•	•	•	•
	S0065601250-250	0.656	1.250	0.250	•	•	•	X	•	•	•	•	•	•
	S0065601375-313	0.656	1.375	0.313	•	•	•	X	•	•	•	•	•	•
	S0065601575-250	0.656	1.575	0.250	•	•	•	X	•	•	X	•	•	•
	S0066901187-185	0.669	1.187	0.185	•	•	•	X	•	•	•	•	•	•
	S0066901250-250	0.669	1.250	0.250	•	•	•	•	•	•	•	•	X	•
	S0068701624-250	0.687	1.624	0.250	•	•	•	•	•	•	X	•	•	•
	S0068801124-250	0.688	1.124	0.250	•	•	•	X	•	•	•	•	•	•
	S0068801125-250	0.688	1.125	0.250	•	•	•	•	•	•	•	X	•	•
	S0068801187-188	0.688	1.187	0.188	•	•	•	X	•	•	•	•	•	•
	S0068801250-313	0.688	1.250	0.313	•	•	•	X	•	•	•	•	•	•
	S0068801375-250	0.688	1.375	0.250	•	•	•	•	•	•	•	•	X	•
	S0068801375-312	0.688	1.375	0.312	•	•	•	•	•	•	•	X	•	•
	S0068801375-313	0.688	1.375	0.313	•	•	•	X	•	•	•	•	•	•
	S0068801499-250	0.688	1.499	0.250	•	•	•	X	•	•	•	•	•	•
	S0071801250-375	0.718	1.250	0.375	•	•	•	•	•	•	X	•	•	•
	S0075000999-156	0.750	0.999	0.156	•	•	•	•	•	•	•	•	•	X
	S0075001000-125	0.750	1.000	0.125	•	•	•	•	•	•	•	•	•	X
	S0075001062-188	0.750	1.062	0.188	•	•	•	•	•	•	X	•	•	•
	S0075001124-125	0.750	1.124	0.125	•	•	•	X	•	•	•	•	•	•
	S0075001124-188	0.750	1.124	0.188	•	•	•	•	•	•	X	•	•	•

X: EXISTING TOOLING    •: ON REQUEST

N.B.: MINIMUM LINE ORDER MAY APPLY

**Tel.: (204) 783-9617**  
**Fax: (204) 783-6091**

**SS**

**19**

[www.sealsonline.com](http://www.sealsonline.com)



## RADIAL SHAFT SEALS - NBR/STEEL

## GLOBAL AVAILABILITY LIST

Ref. Number	Dimensions			DESIGN TYPE										SC
	d	D	H	SC	SB2	SA2	TC	TB2	TA2	VB	VC	KB	KC	
S0075001125-156	0.750	1.125	0.156	*	*	*	*	*	*	*	*	*	*	X
S0075001125-250	0.750	1.125	0.250	*	*	*	*	*	*	*	X	*	*	*
S0075001187-250	0.750	1.187	0.250	*	*	*	X	*	*	*	*	*	*	*
S0075001250-188	0.750	1.250	0.188	*	*	*	X	*	*	*	*	*	*	*
S0075001250-250	0.750	1.250	0.250	*	*	*	X	X	*	X	*	X	*	*
S0075001250-313	0.750	1.250	0.313	*	*	*	*	*	*	*	X	*	*	*
S0075001260-250	0.750	1.260	0.250	*	*	*	X	*	*	*	*	*	*	*
S0075001301-250	0.750	1.301	0.250	*	*	*	*	*	*	*	*	X	*	*
S0075001312-250	0.750	1.312	0.250	*	*	*	*	*	*	X	*	*	*	*
S0075001375-250	0.750	1.375	0.250	*	*	*	*	*	*	X	*	*	*	*
S0075001375-375	0.750	1.375	0.375	*	*	*	X	*	*	*	*	*	*	*
S0075001499-250	0.750	1.499	0.250	*	*	*	X	*	*	X	*	*	*	*
S0075001561-375	0.750	1.561	0.375	*	*	X	*	*	*	*	*	*	*	*
S0075001570-250	0.750	1.570	0.250	*	*	*	*	*	*	*	X	*	*	*
S0075001575-197	0.750	1.575	0.197	*	*	*	*	*	*	*	X	*	*	*
S0075001624-250	0.750	1.624	0.250	*	*	*	*	*	*	X	*	*	*	*
S0075001752-250	0.750	1.752	0.250	*	*	*	X	*	*	X	*	*	*	*
S0075001874-250	0.750	1.874	0.250	*	*	*	X	*	*	X	*	*	*	*
S0075002047-312	0.750	2.047	0.312	*	*	*	*	*	*	X	*	*	*	*
S0075002047-313	0.750	2.047	0.313	*	*	*	X	*	*	*	*	*	*	*
S0075002127-250	0.750	2.127	0.250	*	*	*	*	*	*	X	*	*	*	*
S0078101250-250	0.781	1.250	0.250	*	*	*	*	*	*	X	*	*	*	*
S0078101375-313	0.781	1.375	0.313	*	*	*	X	*	*	*	*	*	*	*
S0078101499-313	0.781	1.499	0.313	*	*	*	X	*	*	*	*	*	*	*
S0078101624-250	0.781	1.624	0.250	*	*	*	X	*	*	*	*	*	*	*
S0078101624-313	0.781	1.624	0.313	*	*	*	*	*	*	X	*	*	*	*
S0078101828-250	0.781	1.828	0.250	*	*	*	*	*	*	X	*	*	*	*
S0078102502-313	0.781	2.502	0.313	*	*	*	*	X	*	*	*	*	*	*
S0078701124-188	0.787	1.124	0.188	*	*	*	X	*	*	*	*	*	*	*
S0078701378-276	0.787	1.378	0.276	*	*	X	*	*	*	*	*	*	*	*
S0081201250-250	0.812	1.250	0.250	*	*	*	*	*	*	X	*	*	*	*
S0081201312-250	0.812	1.312	0.250	*	*	*	X	*	*	*	*	*	*	*
S0081201375-312	0.812	1.375	0.312	*	*	*	*	*	*	X	*	*	*	*
S0081201375-406	0.812	1.375	0.406	*	*	X	*	*	*	*	*	*	*	*
S0081201575-375	0.812	1.575	0.375	*	*	X	*	*	*	*	*	*	*	*
S0081202441-375	0.812	2.441	0.375	*	*	*	*	*	*	X	*	*	*	*
S0081301063-125	0.813	1.063	0.125	*	*	*	*	*	*	*	*	*	*	X
S0081301250-188	0.813	1.250	0.188	*	*	*	X	*	*	*	*	*	*	*
S0081301375-375	0.813	1.375	0.375	*	*	*	X	*	*	*	*	*	*	*
S0081301624-250	0.813	1.624	0.250	*	*	*	*	*	*	X	*	*	*	*
S0081301752-250	0.813	1.752	0.250	*	*	*	X	*	*	*	*	*	*	*
S0084301374-312	0.843	1.374	0.312	*	*	*	*	*	*	X	*	*	*	*
S0084301828-312	0.843	1.828	0.312	*	*	*	*	*	*	X	*	*	*	*
S0084401828-313	0.844	1.828	0.313	*	*	*	*	*	*	X	*	*	*	*
S0087501125-125	0.875	1.125	0.125	*	*	*	*	*	*	*	*	X	*	*
S0087501128-125	0.875	1.128	0.125	*	*	*	*	*	*	*	*	X	*	*
S0087501250-188	0.875	1.250	0.188	*	*	*	X	*	*	X	*	*	*	*
S0087501250-250	0.875	1.250	0.250	*	*	*	*	X	*	*	*	*	*	*

X: EXISTING TOOLING \* : ON REQUEST



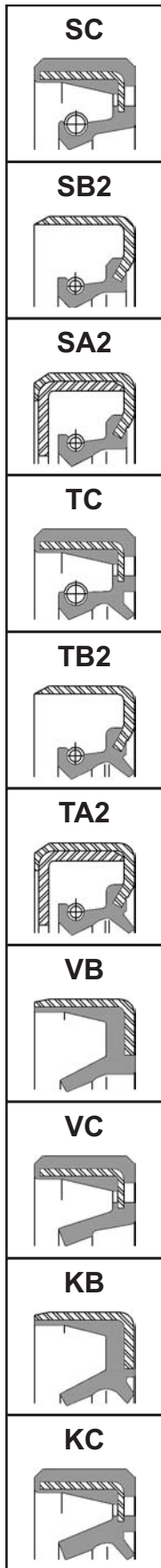







N.B.: MINIMUM LINE ORDER MAY APPLY

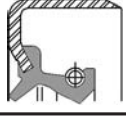
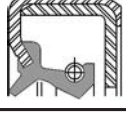

## GLOBAL AVAILABILITY LIST

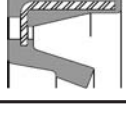
## RADIAL SHAFT SEALS - NBR/STEEL

**INCH SIZE  
SHAFT SEALS**

SC 	Ref. Number	Dimensions			DESIGN TYPE										
		d	D	H	SC	SB2	SA2	TC	TB2	TA2	VB	VC	KB	KC	
	S0087501255-182	0.875	1.255	0.182	•	•	•	•	•	•	•	•	•	X	•
	S0087501375-250	0.875	1.375	0.250	•	•	•	X	•	•	X	X	•	•	•
	S0087501375-252	0.875	1.375	0.252	•	•	•	•	X	•	•	•	•	•	•
	S0087501375-312	0.875	1.375	0.312	•	•	•	X	•	X	X	•	•	•	•
	S0087501375-375	0.875	1.375	0.375	•	•	•	X	•	•	•	•	•	•	•
	S0087501499-250	0.875	1.499	0.250	•	•	•	X	•	•	X	•	•	•	•
	S0087501499-313	0.875	1.499	0.313	•	•	•	X	•	•	•	•	•	•	•
	S0087501500-313	0.875	1.500	0.313	•	•	•	•	•	•	•	X	•	•	•
	S0087501575-250	0.875	1.575	0.250	•	•	•	X	•	•	•	•	•	•	•
	S0087501577-250	0.875	1.577	0.250	•	•	•	•	•	•	X	•	•	•	•
	S0087501624-250	0.875	1.624	0.250	•	•	•	•	•	•	X	•	•	•	•
	S0087501752-250	0.875	1.752	0.250	•	•	•	•	•	•	X	•	•	•	•
	S0087501828-375	0.875	1.828	0.375	•	•	•	•	•	•	X	•	•	•	•
	S0087501874-250	0.875	1.874	0.250	•	•	•	X	•	•	X	•	•	•	•
	S0087502000-250	0.875	2.000	0.250	•	•	•	X	•	•	•	•	•	•	•
	S0090601499-390	0.906	1.499	0.390	•	•	•	•	•	•	X	•	•	•	•
	S0093701499-250	0.937	1.499	0.250	•	•	•	•	•	•	X	•	•	•	•
	S0093701624-250	0.937	1.624	0.250	•	•	•	•	•	•	X	•	•	•	•
	S0093701746-312	0.937	1.746	0.312	•	•	•	•	•	•	•	X	•	•	•
	S0093701750-312	0.937	1.750	0.312	•	•	•	•	•	•	•	X	•	•	•
	S0093701752-250	0.937	1.752	0.250	•	•	•	•	•	•	X	•	•	•	•
	S0093701828-437	0.937	1.828	0.437	•	•	X	•	•	•	•	•	•	•	•
	S0093801375-250	0.938	1.375	0.250	•	•	•	•	•	•	X	•	•	•	•
	S0093801500-250	0.938	1.500	0.250	•	•	•	X	•	•	•	•	•	•	•
	S0093801624-250	0.938	1.624	0.250	•	•	•	X	•	•	•	•	•	•	•
	S0093801752-250	0.938	1.752	0.250	•	•	•	X	•	•	•	•	•	•	•
	S0093801828-250	0.938	1.828	0.250	•	•	•	X	•	•	•	•	•	•	•
	S0093802048-312	0.938	2.048	0.312	•	•	•	•	•	•	•	X	•	•	•
	S0094701625-400	0.947	1.625	0.400	•	•	•	•	X	•	•	•	•	•	•
	S0096801500-187	0.968	1.500	0.187	•	•	•	•	•	•	•	•	•	•	X
	S0096801624-250	0.968	1.624	0.250	•	•	•	•	•	•	X	•	•	•	•
	S0096801688-312	0.968	1.688	0.312	•	•	•	•	•	•	•	X	•	•	•
	S0096801750-312	0.968	1.750	0.312	•	•	•	•	•	•	•	X	•	•	•
	S0096801752-250	0.968	1.752	0.250	•	•	•	•	•	•	X	•	•	•	•
	S0096801828-437	0.968	1.828	0.437	•	•	X	•	•	•	•	•	•	•	•
	S0096801850-375	0.968	1.850	0.375	•	•	•	X	•	•	•	•	•	•	•
	S0096801874-437	0.968	1.874	0.437	•	•	X	•	•	•	•	•	•	•	•
	S0096802047-375	0.968	2.047	0.375	•	•	•	X	•	•	•	•	•	•	•
	S0096802048-375	0.968	2.048	0.375	•	•	•	•	•	•	•	•	X	•	•
	S0096802062-437	0.968	2.062	0.437	•	•	X	•	•	•	•	•	•	•	•
	S0096802440-375	0.968	2.440	0.375	•	•	•	•	•	•	X	•	•	•	•
	S0096901499-313	0.969	1.499	0.313	•	•	X	X	•	•	•	•	•	•	•
	S0096901624-250	0.969	1.624	0.250	•	•	•	X	•	•	•	•	•	•	•
	S0096901752-250	0.969	1.752	0.250	•	•	•	X	•	•	•	•	•	•	•
	S0096901828-438	0.969	1.828	0.438	•	•	•	X	•	•	•	•	•	•	•
	S0096902440-250	0.969	2.440	0.250	•	•	•	•	•	•	•	X	•	•	•
	S0098401499-250	0.984	1.499	0.250	•	•	•	•	•	•	X	•	•	•	•
	S0098401500-250	0.984	1.500	0.250	•	•	•	•	•	•	•	X	•	•	•

X: EXISTING TOOLING    •: ON REQUEST

N.B.: MINIMUM LINE ORDER MAY APPLY

**Tel.: (780) 414-1871**  
**Fax: (780) 487-5419**

**SS 21**

[www.sealsonline.com](http://www.sealsonline.com)



## RADIAL SHAFT SEALS - NBR/STEEL

## GLOBAL AVAILABILITY LIST

Ref. Number	Dimensions			DESIGN TYPE										SC 
	d	D	H	SC	SB2	SA2	TC	TB2	TA2	VB	VC	KB	KC	
S0098401596-250	0.984	1.596	0.250	•	•	•	•	•	•	•	X	•	•	•
S0098402062-437	0.984	2.062	0.437	•	•	X	•	•	•	•	•	•	•	•
S0099901618-195	0.999	1.618	0.195	•	•	•	•	•	•	•	X	•	•	•
S0100001250-250	1.000	1.250	0.250	•	•	•	•	•	•	•	•	X	•	•
S0100001376-250	1.000	1.376	0.250	•	•	•	X	•	•	•	•	•	•	•
S0100001437-125	1.000	1.437	0.125	•	X	•	•	•	•	•	•	•	•	•
S0100001437-250	1.000	1.437	0.250	•	•	•	X	X	•	X	•	•	•	•
S0100001438-250	1.000	1.438	0.250	•	•	•	•	•	•	•	•	X	•	•
S0100001499-188	1.000	1.499	0.188	•	•	•	•	•	•	•	•	•	X	•
S0100001499-250	1.000	1.499	0.250	•	•	•	X	•	•	X	X	•	•	•
S0100001499-312	1.000	1.499	0.312	•	•	•	•	•	•	X	•	•	•	•
S0100001500-312	1.000	1.500	0.312	•	•	•	•	•	•	•	•	X	•	•
S0100001561-250	1.000	1.561	0.250	•	•	•	•	•	•	•	X	•	X	•
S0100001575-250	1.000	1.575	0.250	•	•	•	•	•	•	•	X	•	•	•
S0100001624-250	1.000	1.624	0.250	•	•	•	X	•	•	X	•	•	X	•
S0100001624-437	1.000	1.624	0.437	•	•	X	•	•	•	•	•	•	•	•
S0100001686-250	1.000	1.686	0.250	•	•	•	•	•	•	•	X	•	•	•
S0100001750-375	1.000	1.750	0.375	•	•	•	•	X	•	•	•	•	•	•
S0100001752-250	1.000	1.752	0.250	•	•	•	X	•	•	X	X	•	•	•
S0100001752-312	1.000	1.752	0.312	•	•	•	•	•	•	X	•	•	•	•
S0100001752-375	1.000	1.752	0.375	•	•	X	•	•	•	X	•	•	•	•
S0100001781-469	1.000	1.781	0.469	•	•	•	•	•	•	•	•	•	X	•
S0100001828-250	1.000	1.828	0.250	•	•	•	•	•	•	•	X	•	•	•
S0100001851-250	1.000	1.851	0.250	•	•	•	X	•	•	•	•	•	X	•
S0100001874-250	1.000	1.874	0.250	•	•	•	X	•	•	X	•	•	•	•
S0100001938-250	1.000	1.938	0.250	•	•	•	•	•	•	•	•	•	X	•
S0100001982-313	1.000	1.982	0.313	•	•	•	•	•	•	•	X	•	•	•
S0100002000-250	1.000	2.000	0.250	•	•	•	X	•	•	X	•	•	•	•
S0100002000-500	1.000	2.000	0.500	•	•	•	•	•	•	•	•	X	•	•
S0100002047-250	1.000	2.047	0.250	•	•	•	•	•	•	•	X	•	•	•
S0100002047-312	1.000	2.047	0.312	•	•	•	•	•	•	•	X	•	•	•
S0100002047-375	1.000	2.047	0.375	•	•	•	•	•	•	•	•	X	•	•
S0100002062-250	1.000	2.062	0.250	•	•	•	•	•	•	•	X	•	•	•
S0100002062-375	1.000	2.062	0.375	•	•	•	•	X	•	•	•	•	•	•
S0100002063-250	1.000	2.063	0.250	•	•	•	X	•	•	•	•	•	•	•
S0100002250-250	1.000	2.250	0.250	•	•	•	X	•	•	•	•	•	•	•
S0100002441-375	1.000	2.441	0.375	•	•	•	•	•	•	•	X	X	•	•
S0100002533-250	1.000	2.533	0.250	•	•	•	•	•	•	•	X	•	•	•
S0103101575-313	1.031	1.575	0.313	•	•	X	•	•	•	•	•	•	•	•
S0106201561-375	1.062	1.561	0.375	•	•	X	•	•	•	•	•	•	•	•
S0106201686-375	1.062	1.686	0.375	•	•	•	•	•	•	•	X	•	•	•
S0106201752-312	1.062	1.752	0.312	•	•	•	•	•	•	•	X	•	•	•
S0106201828-375	1.062	1.828	0.375	•	•	•	•	•	•	•	X	•	•	•
S0106201874-250	1.062	1.874	0.250	•	•	•	•	•	•	•	X	•	•	•
S0106201983-437	1.062	1.983	0.437	•	•	X	•	•	•	•	•	•	•	•
S0106202000-250	1.062	2.000	0.250	•	•	•	•	•	•	•	X	•	•	•
S0106202062-375	1.062	2.062	0.375	•	•	•	•	•	•	•	X	•	•	•
S0106202835-375	1.062	2.835	0.375	•	•	•	•	•	•	•	X	•	•	•

X: EXISTING TOOLING •: ON REQUEST



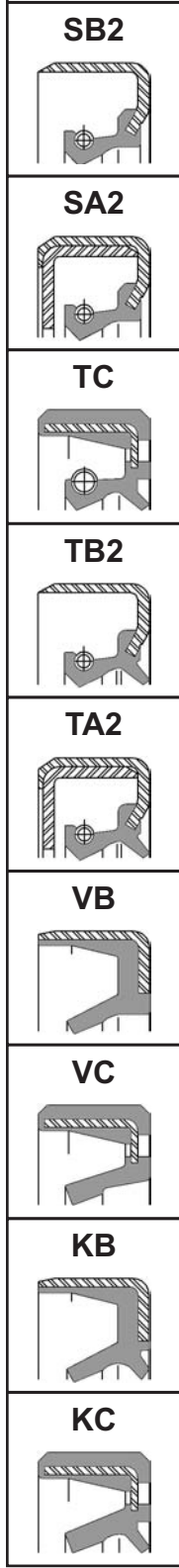



N.B.: MINIMUM LINE ORDER MAY APPLY



## GLOBAL AVAILABILITY LIST

## RADIAL SHAFT SEALS - NBR/STEEL

INCH SIZE  
SHAFT SEALS

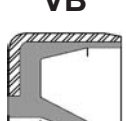
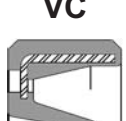
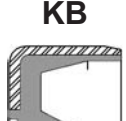
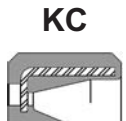
SC 	Ref. Number	Dimensions			DESIGN TYPE									
		d	D	H	SC	SB2	SA2	TC	TB2	TA2	VB	VC	KB	KC
	S0106301499-250	1.063	1.499	0.250	•	•	•	X	•	•	•	X	•	•
	S0106301561-250	1.063	1.561	0.250	•	•	•	X	•	•	•	•	•	•
	S0106301624-250	1.063	1.624	0.250	•	•	•	X	•	•	•	•	•	•
	S0106301686-250	1.063	1.686	0.250	•	•	•	X	•	•	•	•	•	•
	S0106301752-250	1.063	1.752	0.250	•	•	•	X	•	•	•	•	•	•
	S0106301874-250	1.063	1.874	0.250	•	•	•	X	•	•	•	•	•	•
	S0106301979-250	1.063	1.979	0.250	•	•	•	X	•	•	•	•	•	•
	S0106302000-250	1.063	2.000	0.250	•	•	•	X	•	•	•	•	•	•
	S0106302062-250	1.063	2.062	0.250	•	•	•	X	•	•	•	•	•	•
	S0108501561-375	1.085	1.561	0.375	•	•	•	•	•	•	X	•	•	•
	S0112501438-203	1.125	1.438	0.203	•	•	•	•	•	•	•	•	X	•
	S0112501499-188	1.125	1.499	0.188	•	•	•	X	•	•	•	•	X	•
	S0112501499-250	1.125	1.499	0.250	•	X	•	•	•	•	•	•	•	•
	S0112501561-250	1.125	1.561	0.250	•	•	•	•	•	•	X	•	•	•
	S0112501562-250	1.125	1.562	0.250	•	•	•	X	•	•	•	•	X	•
	S0112501562-375	1.125	1.562	0.375	•	•	X	•	•	•	•	•	•	•
	S0112501565-250	1.125	1.565	0.250	•	•	•	X	•	•	•	•	•	•
	S0112501569-197	1.125	1.569	0.197	•	•	•	•	•	•	•	•	X	•
	S0112501575-250	1.125	1.575	0.250	•	•	•	•	•	•	X	•	•	•
	S0112501624-190	1.125	1.624	0.190	•	•	•	X	•	•	•	•	•	•
	S0112501624-250	1.125	1.624	0.250	•	•	•	X	•	•	X	•	•	•
	S0112501625-250	1.125	1.625	0.250	•	•	•	•	X	•	•	•	•	•
	S0112501625-312	1.125	1.625	0.312	•	•	•	•	X	•	•	•	•	•
	S0112501733-375	1.125	1.733	0.375	•	•	•	X	•	•	•	•	•	•
	S0112501752-250	1.125	1.752	0.250	•	•	•	X	•	•	X	•	X	•
	S0112501778-406	1.125	1.778	0.406	•	X	•	•	•	•	•	•	•	•
	S0112501780-469	1.125	1.780	0.469	•	•	•	•	•	•	•	•	X	•
	S0112501781-469	1.125	1.781	0.469	•	•	•	•	•	•	X	•	•	•
	S0112501828-250	1.125	1.828	0.250	•	•	•	X	•	•	X	X	•	•
	S0112501832-312	1.125	1.832	0.312	•	•	•	•	•	•	•	X	•	•
	S0112501850-312	1.125	1.850	0.312	•	•	•	•	X	•	•	•	•	•
	S0112501851-313	1.125	1.851	0.313	•	•	X	•	•	•	•	•	•	•
	S0112501874-250	1.125	1.874	0.250	•	•	•	X	•	•	X	•	•	•
	S0112501874-438	1.125	1.874	0.438	•	•	X	•	•	•	•	•	•	•
	S0112501938-563	1.125	1.938	0.563	•	•	•	•	•	•	X	•	X	•
	S0112501983-250	1.125	1.983	0.250	•	•	•	X	•	•	X	•	•	•
	S0112502000-250	1.125	2.000	0.250	•	•	•	X	•	•	•	•	•	•
	S0112502000-375	1.125	2.000	0.375	•	•	•	•	•	•	X	•	•	•
	S0112502047-250	1.125	2.047	0.250	•	•	•	•	•	•	•	•	X	•
	S0112502047-312	1.125	2.047	0.312	•	•	•	•	•	•	X	•	•	•
	S0112502062-250	1.125	2.062	0.250	•	•	•	•	•	•	X	•	X	•
	S0112502062-437	1.125	2.062	0.437	•	•	X	•	•	•	•	•	•	•
	S0112502063-313	1.125	2.063	0.313	•	•	•	X	•	•	•	•	•	•
	S0112502125-313	1.125	2.125	0.313	•	•	•	X	•	•	•	•	•	•
	S0112502250-250	1.125	2.250	0.250	•	•	•	X	•	•	•	•	•	•
	S0112502250-500	1.125	2.250	0.500	•	•	X	•	•	•	•	•	•	•
	S0112502437-468	1.125	2.437	0.468	•	•	X	•	•	•	•	•	•	•
	S0112502441-250	1.125	2.441	0.250	•	•	•	X	X	•	X	•	•	•

X: EXISTING TOOLING    •: ON REQUEST

N.B.: MINIMUM LINE ORDER MAY APPLY

Tel.: (604) 278-6808  
Fax: (604) 278-6180

**SS**

**23**

[www.sealsonline.com](http://www.sealsonline.com)





## RADIAL SHAFT SEALS - NBR/STEEL

## GLOBAL AVAILABILITY LIST

Ref. Number	Dimensions			DESIGN TYPE										SC 
	d	D	H	SC	SB2	SA2	TC	TB2	TA2	VB	VC	KB	KC	
S0112502533-250	1.125	2.533	0.250	•	•	•	•	•	•	X	•	•	•	
S0112502835-375	1.125	2.835	0.375	•	•	•	•	•	•	X	•	•	•	
S0115601686-250	1.156	1.686	0.250	•	•	•	•	•	•	X	•	•	•	
S0115601686-312	1.156	1.686	0.312	•	•	•	•	•	•	•	X	•	•	
S0115601874-250	1.156	1.874	0.250	•	•	•	X	•	•	•	•	•	•	
S0115602000-250	1.156	2.000	0.250	•	•	•	•	•	•	X	•	•	•	
S0115602062-375	1.156	2.062	0.375	•	•	•	•	•	•	X	•	•	•	
S0115602063-313	1.156	2.063	0.313	•	•	•	X	•	•	•	•	•	•	
S0115602125-437	1.156	2.125	0.437	•	•	•	•	•	•	X	•	•	•	
S0115602834-375	1.156	2.834	0.375	•	•	•	•	•	•	X	•	•	•	
S0117002031-375	1.170	2.031	0.375	•	•	X	•	•	•	•	•	•	•	
S0117501828-375	1.175	1.828	0.375	•	•	•	•	•	X	X	•	•	•	
S0117502031-500	1.175	2.031	0.500	•	•	•	X	•	•	•	•	•	•	
S0118101454-158	1.181	1.454	0.158	•	•	•	•	•	•	•	•	•	X	
S0118701627-250	1.187	1.627	0.250	•	•	•	•	•	•	•	•	•	X	
S0118701828-375	1.187	1.828	0.375	•	•	•	•	•	•	X	•	•	•	
S0118701874-250	1.187	1.874	0.250	•	•	•	•	•	•	X	•	•	•	
S0118702062-250	1.187	2.062	0.250	•	•	•	•	•	•	X	•	•	•	
S0118702125-250	1.187	2.125	0.250	•	•	•	•	•	•	X	•	•	•	
S0118702250-250	1.187	2.250	0.250	•	•	•	•	•	•	X	•	•	•	
S0118702437-250	1.187	2.437	0.250	•	•	•	•	•	•	X	•	•	•	
S0118702441-250	1.187	2.441	0.250	•	•	•	•	•	•	X	•	•	•	
S0118702686-500	1.187	2.686	0.500	•	•	•	•	•	•	X	•	•	•	
S0118801686-375	1.188	1.686	0.375	•	•	•	•	X	•	•	•	•	•	
S0118801687-250	1.188	1.687	0.250	•	•	•	X	•	•	•	•	•	•	
S0118801752-250	1.188	1.752	0.250	•	•	•	X	•	•	•	•	•	•	
S0118801828-375	1.188	1.828	0.375	•	•	•	X	•	•	•	•	•	•	
S0118801874-375	1.188	1.874	0.375	•	•	•	X	•	•	•	•	•	•	
S0118801875-250	1.188	1.875	0.250	•	•	•	X	•	•	•	•	•	•	
S0118801983-250	1.188	1.983	0.250	•	•	•	X	•	•	X	•	•	•	
S0118802000-250	1.188	2.000	0.250	•	•	•	X	•	•	X	•	•	•	
S0118802125-313	1.188	2.125	0.313	•	•	•	X	•	•	•	•	•	•	
S0118802441-250	1.188	2.441	0.250	•	•	•	X	•	•	•	•	•	•	
S0118802441-380	1.188	2.441	0.380	•	•	•	X	•	•	•	•	•	•	
S0121801983-437	1.218	1.983	0.437	•	•	X	•	•	•	•	•	•	•	
S0121802000-437	1.218	2.000	0.437	•	•	X	•	X	•	•	•	•	•	
S0121901968-469	1.219	1.968	0.469	•	•	•	•	•	•	•	•	X	•	
S0121901979-250	1.219	1.979	0.250	•	•	•	•	•	•	X	•	X	•	
S0121901979-406	1.219	1.979	0.406	•	•	•	•	•	•	X	X	X	•	
S0121901983-250	1.219	1.983	0.250	•	•	•	•	•	•	•	X	•	•	
S0123402250-250	1.234	2.250	0.250	•	•	•	X	•	•	•	•	•	•	
S0125001500-125	1.250	1.500	0.125	•	•	•	•	•	•	•	•	X	•	
S0125001504-156	1.250	1.504	0.156	•	•	•	•	•	•	•	•	X	•	
S0125001625-188	1.250	1.625	0.188	•	•	•	X	•	•	•	•	•	•	
S0125001625-250	1.250	1.625	0.250	•	•	•	•	•	•	•	X	•	•	
S0125001686-188	1.250	1.686	0.188	•	•	•	•	•	•	•	•	X	•	
S0125001686-250	1.250	1.686	0.250	•	•	•	•	X	•	X	•	•	•	
S0125001687-250	1.250	1.687	0.250	•	•	•	X	•	•	•	X	•	•	

X: EXISTING TOOLING •: ON REQUEST



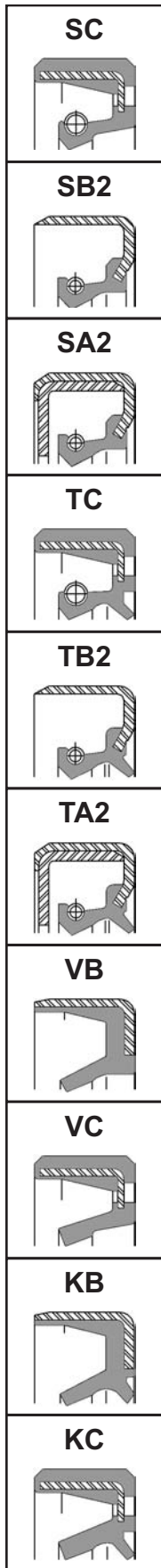







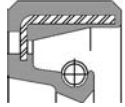
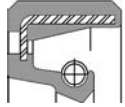





N.B.: MINIMUM LINE ORDER MAY APPLY



## GLOBAL AVAILABILITY LIST

## RADIAL SHAFT SEALS - NBR/STEEL

**INCH SIZE  
SHAFT SEALS**

SC 	Ref. Number	Dimensions			DESIGN TYPE									
		d	D	H	SC	SB2	SA2	TC	TB2	TA2	VB	VC	KB	KC
	S0125001687-313	1.250	1.687	0.313	•	•	•	•	•	•	X	•	•	•
	S0125001752-250	1.250	1.752	0.250	•	•	•	•	•	•	X	•	•	•
	S0125001753-250	1.250	1.753	0.250	•	•	•	•	•	•	•	X	•	•
	S0125001874-250	1.250	1.874	0.250	•	•	•	X	•	•	X	•	•	•
	S0125001953-484	1.250	1.953	0.484	X	•	•	•	•	•	•	•	•	•
	S0125001955-250	1.250	1.955	0.250	•	•	•	•	•	•	X	•	•	•
	S0125001955-435	1.250	1.955	0.435	•	•	•	X	•	•	•	•	•	•
	S0125001968-438	1.250	1.968	0.438	•	•	•	•	•	•	•	•	X	•
	S0125001979-250	1.250	1.979	0.250	•	•	•	•	•	•	X	X	X	•
	S0125001979-406	1.250	1.979	0.406	•	•	•	•	•	•	•	•	X	•
	S0125001983-250	1.250	1.983	0.250	•	•	•	•	•	•	X	•	X	•
	S0125001983-437	1.250	1.983	0.437	•	•	X	•	•	•	•	•	•	•
	S0125002000-250	1.250	2.000	0.250	•	•	•	X	•	•	X	•	X	•
	S0125002000-312	1.250	2.000	0.312	•	•	•	•	•	•	•	X	•	•
	S0125002000-375	1.250	2.000	0.375	•	•	•	X	•	•	•	•	•	•
	S0125002000-438	1.250	2.000	0.438	•	•	•	X	•	•	•	•	•	•
	S0125002047-375	1.250	2.047	0.375	•	•	•	•	•	•	X	•	•	•
	S0125002062-250	1.250	2.062	0.250	•	•	•	•	•	•	X	•	•	•
	S0125002062-438	1.250	2.062	0.438	•	•	X	•	•	•	•	•	•	•
	S0125002125-250	1.250	2.125	0.250	•	•	•	X	X	•	X	•	•	•
	S0125002250-250	1.250	2.250	0.250	•	•	•	•	•	•	•	•	X	•
	S0125002250-375	1.250	2.250	0.375	•	•	•	•	•	•	•	X	•	•
	S0125002252-375	1.250	2.252	0.375	•	•	•	•	•	•	X	•	•	•
	S0125002374-313	1.250	2.374	0.313	•	•	•	•	•	•	X	•	•	•
	S0125002437-313	1.250	2.437	0.313	•	•	•	•	X	•	•	•	•	•
	S0125002437-375	1.250	2.437	0.375	•	•	•	•	•	•	X	•	•	•
	S0125002438-250	1.250	2.438	0.250	•	•	•	X	•	•	•	•	•	•
	S0125002440-310	1.250	2.440	0.310	•	•	•	•	•	•	•	X	•	•
	S0125002441-250	1.250	2.441	0.250	•	•	•	X	•	•	•	•	•	•
	S0125002441-375	1.250	2.441	0.375	•	•	•	•	•	•	X	•	•	•
	S0125002502-313	1.250	2.502	0.313	•	•	•	X	•	•	•	•	•	•
	S0125002502-375	1.250	2.502	0.375	•	•	•	•	•	•	X	•	•	•
	S0125002561-500	1.250	2.561	0.500	•	•	X	•	•	•	•	•	•	•
	S0125002713-468	1.250	2.713	0.468	•	•	X	•	•	•	•	•	•	•
	S0125002835-375	1.250	2.835	0.375	•	•	•	•	•	•	X	X	•	•
	S0125002877-250	1.250	2.877	0.250	•	•	•	•	•	•	X	•	•	•
	S0125003155-500	1.250	3.155	0.500	•	•	X	•	•	•	•	•	•	•
	S0125003156-500	1.250	3.156	0.500	•	•	•	•	•	•	X	•	•	•
	S0126001771-315	1.260	1.771	0.315	•	•	•	•	•	•	•	X	•	•
	S0128102000-375	1.281	2.000	0.375	•	•	•	•	•	•	X	•	•	•
	S0130102046-490	1.301	2.046	0.490	•	•	•	•	•	•	X	•	•	•
	S0131201874-375	1.312	1.874	0.375	•	•	•	•	•	•	X	•	•	•
	S0131201983-375	1.312	1.983	0.375	•	•	•	•	•	•	X	•	•	•
	S0131202000-312	1.312	2.000	0.312	•	•	•	•	•	•	X	•	•	•
	S0131202062-437	1.312	2.062	0.437	•	•	•	•	•	•	X	•	•	•
	S0131202106-375	1.312	2.106	0.375	•	•	•	•	•	•	X	•	•	•
	S0131202125-312	1.312	2.125	0.312	•	•	•	•	•	•	X	•	•	•
	S0131202250-312	1.312	2.250	0.312	•	•	•	•	•	•	X	•	•	•

X: EXISTING TOOLING    •: ON REQUEST

N.B.: MINIMUM LINE ORDER MAY APPLY

**Tel.: (418) 688-3202**  
**Fax: (418) 688-4272**

**SS 25**

[www.sealsonline.com](http://www.sealsonline.com)



## RADIAL SHAFT SEALS - NBR/STEEL

## GLOBAL AVAILABILITY LIST

Ref. Number	Dimensions			DESIGN TYPE										SC
	d	D	H	SC	SB2	SA2	TC	TB2	TA2	VB	VC	KB	KC	
S0131202374-312	1.312	2.374	0.312	•	•	•	•	•	•	X	•	•	•	
S0131202374-500	1.312	2.374	0.500	•	•	X	•	•	•	•	•	•	•	
S0131202835-468	1.312	2.835	0.468	•	•	•	•	•	•	X	•	•	•	
S0131302062-313	1.313	2.062	0.313	•	•	•	X	•	•	X	•	•	•	
S0131302250-313	1.313	2.250	0.313	•	•	•	X	•	•	•	•	•	•	
S0131302282-250	1.313	2.282	0.250	•	•	•	•	•	•	X	•	•	•	
S0132602061-375	1.326	2.061	0.375	•	•	•	X	•	•	•	•	•	•	
S0132802061-313	1.328	2.061	0.313	•	•	•	X	•	•	•	•	•	•	
S0132802227-313	1.328	2.227	0.313	•	•	•	X	•	•	•	•	•	•	
S0132802312-435	1.328	2.312	0.435	•	•	•	X	•	•	•	•	•	•	
S0136502081-313	1.365	2.081	0.313	•	•	•	X	•	•	•	•	•	•	
S0136502261-313	1.365	2.261	0.313	•	•	•	X	•	•	•	•	•	•	
S0136502374-435	1.365	2.374	0.435	•	•	•	X	•	•	•	•	•	•	
S0136502502-600	1.365	2.502	0.600	•	•	•	•	•	•	X	•	•	•	
S0137201979-490	1.372	1.979	0.490	•	•	•	X	•	•	•	•	•	•	
S0137201979-500	1.372	1.979	0.500	•	•	•	•	•	•	X	•	•	•	
S0137501750-188	1.375	1.750	0.188	•	•	•	•	•	•	•	•	X	•	
S0137501750-219	1.375	1.750	0.219	•	•	•	•	•	•	X	•	•	•	
S0137501828-250	1.375	1.828	0.250	•	•	•	X	•	•	•	•	•	•	
S0137501828-313	1.375	1.828	0.313	•	•	•	X	•	•	•	•	•	•	
S0137501835-250	1.375	1.835	0.250	•	•	•	X	•	•	•	•	•	•	
S0137501874-188	1.375	1.874	0.188	•	•	•	•	•	•	•	•	X	•	
S0137501874-250	1.375	1.874	0.250	•	•	•	X	•	•	X	•	X	•	
S0137501874-313	1.375	1.874	0.313	•	•	•	•	•	•	X	•	•	•	
S0137501874-437	1.375	1.874	0.437	•	•	•	•	•	X	•	•	•	•	
S0137501938-250	1.375	1.938	0.250	•	•	•	•	•	•	X	•	X	•	
S0137501983-375	1.375	1.983	0.375	•	•	X	•	•	•	•	•	•	•	
S0137502000-312	1.375	2.000	0.312	•	•	•	•	•	•	•	X	•	•	
S0137502000-313	1.375	2.000	0.313	•	•	X	X	•	•	X	•	•	•	
S0137502000-328	1.375	2.000	0.328	•	•	X	•	•	•	•	•	•	•	
S0137502000-375	1.375	2.000	0.375	•	•	•	•	•	X	•	•	•	•	
S0137502062-250	1.375	2.062	0.250	•	•	•	•	X	•	•	X	•	•	
S0137502063-313	1.375	2.063	0.313	•	•	•	X	•	•	•	•	•	•	
S0137502106-313	1.375	2.106	0.313	•	•	•	•	•	•	X	•	•	•	
S0137502125-312	1.375	2.125	0.312	•	•	•	•	•	•	•	X	•	•	
S0137502125-313	1.375	2.125	0.313	•	•	X	X	•	•	X	•	•	•	
S0137502125-438	1.375	2.125	0.438	•	•	X	•	•	•	•	•	•	•	
S0137502250-312	1.375	2.250	0.312	•	•	•	•	•	•	X	•	•	•	
S0137502250-313	1.375	2.250	0.313	•	•	•	X	•	•	•	•	•	•	
S0137502282-250	1.375	2.282	0.250	•	•	•	•	•	•	•	•	X	•	
S0137502374-312	1.375	2.374	0.312	•	•	•	•	•	•	X	•	•	•	
S0137502374-313	1.375	2.374	0.313	•	•	•	X	•	•	•	•	•	•	
S0137502437-250	1.375	2.437	0.250	•	•	•	X	•	•	•	•	•	•	
S0137502438-250	1.375	2.438	0.250	•	•	•	X	•	•	•	•	•	•	
S0137502441-313	1.375	2.441	0.313	•	•	•	X	•	•	X	•	•	•	
S0137502500-321	1.375	2.500	0.321	•	•	•	•	•	•	X	•	•	•	
S0137502502-313	1.375	2.502	0.313	•	•	•	X	•	•	•	•	•	•	
S0137502502-375	1.375	2.502	0.375	•	•	•	•	•	•	X	•	•	•	

X: EXISTING TOOLING •: ON REQUEST



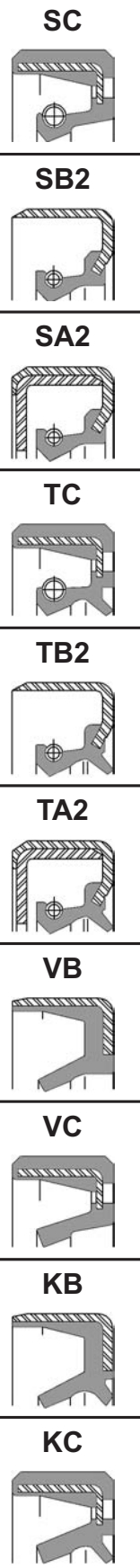



N.B.: MINIMUM LINE ORDER MAY APPLY



## GLOBAL AVAILABILITY LIST

## RADIAL SHAFT SEALS - NBR/STEEL

INCH SIZE  
SHAFT SEALS

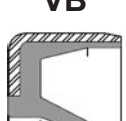
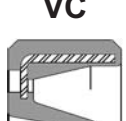
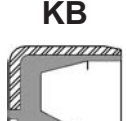
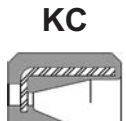
SC 	Ref. Number	Dimensions			DESIGN TYPE									
		d	D	H	SC	SB2	SA2	TC	TB2	TA2	VB	VC	KB	KC
	S0137502562-375	1.375	2.562	0.375	•	•	•	X	•	•	X	•	•	•
	S0137502623-313	1.375	2.623	0.313	•	•	•	•	•	•	X	•	•	•
	S0137502623-375	1.375	2.623	0.375	•	•	•	•	•	•	X	•	•	•
	S0137502716-313	1.375	2.716	0.313	•	•	•	X	•	•	•	•	•	•
	S0137502716-468	1.375	2.716	0.468	•	•	X	•	•	•	•	•	•	•
	S0137502835-313	1.375	2.835	0.313	•	•	•	•	•	•	X	•	•	•
	S0137502875-468	1.375	2.875	0.468	•	•	•	•	•	•	X	•	•	•
	S0137503150-375	1.375	3.150	0.375	•	•	•	•	•	•	X	•	•	•
	S0137503189-500	1.375	3.189	0.500	•	•	•	X	•	•	•	•	•	•
	S0137503350-468	1.375	3.350	0.468	•	•	X	•	•	•	•	•	•	•
	S0139902292-500	1.399	2.292	0.500	•	•	•	•	•	•	X	•	•	•
	S0141702614-313	1.417	2.614	0.313	•	•	•	X	•	•	•	•	•	•
	S0143701937-250	1.437	1.937	0.250	•	•	•	X	•	•	•	•	•	•
	S0143701998-125	1.437	1.998	0.125	•	•	•	•	•	•	•	•	•	X
	S0143702312-375	1.437	2.312	0.375	•	•	•	•	•	•	X	•	•	•
	S0143702437-312	1.437	2.437	0.312	•	•	•	•	•	•	X	•	•	•
	S0143702502-312	1.437	2.502	0.312	•	•	•	•	•	•	X	•	•	•
	S0143702502-500	1.437	2.502	0.500	•	•	X	•	•	•	•	•	•	•
	S0143702686-375	1.437	2.686	0.375	•	•	•	•	•	•	X	•	•	•
	S0143703000-500	1.437	3.000	0.500	•	•	•	•	•	•	X	•	•	•
	S0143801978-500	1.438	1.978	0.500	•	•	•	•	•	•	•	X	•	•
	S0143802000-313	1.438	2.000	0.313	•	•	•	•	•	•	•	X	•	•
	S0143802063-313	1.438	2.063	0.313	•	•	•	•	•	•	X	•	•	•
	S0143802125-313	1.438	2.125	0.313	•	•	•	X	•	•	X	•	•	•
	S0143802125-375	1.438	2.125	0.375	•	•	•	•	X	•	•	•	•	•
	S0143802250-313	1.438	2.250	0.313	•	•	•	•	•	•	X	•	•	•
	S0143802374-313	1.438	2.374	0.313	•	•	•	•	•	•	X	•	•	•
	S0143802437-313	1.438	2.437	0.313	•	•	•	X	•	•	•	•	•	•
	S0143802502-313	1.438	2.502	0.313	•	•	•	X	•	•	•	•	•	•
	S0143802686-313	1.438	2.686	0.313	•	•	•	X	•	•	•	•	•	•
	S0143802750-313	1.438	2.750	0.313	•	•	•	X	•	•	•	•	•	•
	S0145002075-312	1.450	2.075	0.312	•	•	•	X	•	•	•	•	•	•
	S0146802375-375	1.468	2.375	0.375	•	•	•	•	•	•	X	•	•	•
	S0146802437-375	1.468	2.437	0.375	•	•	•	•	•	•	X	•	•	•
	S0148402254-313	1.484	2.254	0.313	•	•	•	X	•	•	•	•	•	•
	S0150001874-250	1.500	1.874	0.250	•	•	•	X	•	•	X	•	X	X
	S0150001938-250	1.500	1.938	0.250	•	•	•	•	•	•	•	•	X	•
	S0150001983-188	1.500	1.983	0.188	•	•	•	•	•	•	X	•	X	•
	S0150001983-250	1.500	1.983	0.250	•	•	•	•	•	•	X	X	•	•
	S0150001983-313	1.500	1.983	0.313	•	•	•	X	•	•	•	•	•	•
	S0150001984-438	1.500	1.984	0.438	•	•	X	•	•	•	•	•	•	•
	S0150001989-250	1.500	1.989	0.250	X	•	•	•	•	•	X	•	•	•
	S0150002000-250	1.500	2.000	0.250	•	•	•	•	X	•	•	•	X	•
	S0150002000-312	1.500	2.000	0.312	•	•	•	X	•	•	•	•	•	•
	S0150002000-313	1.500	2.000	0.313	•	•	•	X	•	•	X	•	•	•
	S0150002048-375	1.500	2.048	0.375	•	•	•	•	•	•	X	•	•	•
	S0150002062-210	1.500	2.062	0.210	•	•	•	•	•	•	•	•	X	•
S0150002062-313	1.500	2.062	0.313	•	•	•	X	•	•	•	•	•	•	

X: EXISTING TOOLING    •: ON REQUEST

N.B.: MINIMUM LINE ORDER MAY APPLY

Tel.: (514) 334-2220  
Fax: (514) 333-8329

**SS**

**27**

[www.sealsonline.com](http://www.sealsonline.com)



## RADIAL SHAFT SEALS - NBR/STEEL

## GLOBAL AVAILABILITY LIST

Ref. Number	Dimensions			DESIGN TYPE										SC 
	d	D	H	SC	SB2	SA2	TC	TB2	TA2	VB	VC	KB	KC	
S0150002066-250	1.500	2.066	0.250	•	•	•	•	X	•	•	•	•	•	
S0150002125-312	1.500	2.125	0.312	•	•	•	X	•	•	X	•	•	•	
S0150002222-312	1.500	2.222	0.312	•	•	•	•	•	•	X	•	•	•	
S0150002250-313	1.500	2.250	0.313	•	•	•	X	•	•	X	•	•	•	
S0150002254-312	1.500	2.254	0.312	•	•	X	•	•	•	•	•	•	•	
S0150002260-406	1.500	2.260	0.406	•	•	•	•	•	X	•	•	•	•	
S0150002328-406	1.500	2.328	0.406	•	•	•	•	•	•	•	•	X	•	
S0150002328-500	1.500	2.328	0.500	•	•	•	•	•	•	X	•	X	•	
S0150002332-406	1.500	2.332	0.406	•	•	•	•	•	•	X	•	•	•	
S0150002374-250	1.500	2.374	0.250	•	X	•	•	•	•	•	•	•	•	
S0150002374-313	1.500	2.374	0.313	•	•	•	•	•	•	X	•	•	•	
S0150002374-500	1.500	2.374	0.500	•	•	X	•	•	•	•	•	•	•	
S0150002437-313	1.500	2.437	0.313	•	•	•	X	•	•	•	•	•	•	
S0150002437-375	1.500	2.437	0.375	•	•	•	•	•	•	X	•	•	•	
S0150002438-250	1.500	2.438	0.250	•	•	•	•	•	•	•	•	X	•	
S0150002440-617	1.500	2.440	0.617	•	•	•	•	•	X	•	•	•	•	
S0150002500-375	1.500	2.500	0.375	•	•	•	•	•	X	•	•	•	•	
S0150002502-312	1.500	2.502	0.312	•	•	•	•	•	•	X	•	•	•	
S0150002502-313	1.500	2.502	0.313	•	•	•	X	•	•	•	•	•	•	
S0150002502-500	1.500	2.502	0.500	•	•	X	•	•	•	•	•	•	•	
S0150002561-313	1.500	2.561	0.313	•	•	•	X	•	•	X	•	•	•	
S0150002561-500	1.500	2.561	0.500	•	•	•	•	•	X	•	•	•	•	
S0150002686-500	1.500	2.686	0.500	•	•	•	•	•	•	X	•	•	•	
S0150002716-468	1.500	2.716	0.468	•	•	X	•	•	•	•	•	•	•	
S0150002721-325	1.500	2.721	0.325	•	•	•	•	•	•	•	X	•	•	
S0150002750-312	1.500	2.750	0.312	•	•	•	•	•	•	X	•	•	•	
S0150002750-313	1.500	2.750	0.313	•	•	•	X	•	•	•	•	•	•	
S0150002758-312	1.500	2.758	0.312	•	•	•	•	•	•	X	•	•	•	
S0150002758-500	1.500	2.758	0.500	•	•	•	•	•	•	•	X	•	•	
S0150002835-313	1.500	2.835	0.313	•	•	•	•	•	•	X	•	•	•	
S0150002875-313	1.500	2.875	0.313	•	•	•	X	•	•	•	•	•	•	
S0150002875-468	1.500	2.875	0.468	•	•	X	•	•	•	•	•	•	•	
S0150002996-500	1.500	2.996	0.500	•	•	X	•	•	•	•	•	•	•	
S0150003000-375	1.500	3.000	0.375	•	•	•	•	•	•	X	•	•	•	
S0150003150-500	1.500	3.150	0.500	•	•	•	•	•	•	X	•	•	•	
S0150202377-453	1.502	2.377	0.453	•	•	•	•	•	•	X	•	•	•	
S0153102374-375	1.531	2.374	0.375	•	•	X	•	•	•	•	•	•	•	
S0156202125-375	1.562	2.125	0.375	•	•	•	•	•	•	X	•	•	•	
S0156202250-312	1.562	2.250	0.312	•	•	•	•	•	•	•	X	•	•	
S0156202250-375	1.562	2.250	0.375	•	•	•	•	X	•	•	•	•	•	
S0156202250-500	1.562	2.250	0.500	•	•	•	•	•	X	•	•	•	•	
S0156202437-375	1.562	2.437	0.375	•	•	•	•	•	•	X	•	•	•	
S0156202502-500	1.562	2.502	0.500	•	•	X	•	•	•	•	•	•	•	
S0156202531-500	1.562	2.531	0.500	•	•	X	•	•	•	•	•	•	•	
S0156202686-375	1.562	2.686	0.375	•	•	•	•	•	•	X	•	•	•	
S0156202758-500	1.562	2.758	0.500	•	•	X	•	•	•	•	•	•	•	
S0156202875-375	1.562	2.875	0.375	•	•	•	•	•	•	X	•	•	•	
S0156203150-312	1.562	3.150	0.312	•	•	•	•	•	•	X	•	•	•	

X: EXISTING TOOLING •: ON REQUEST



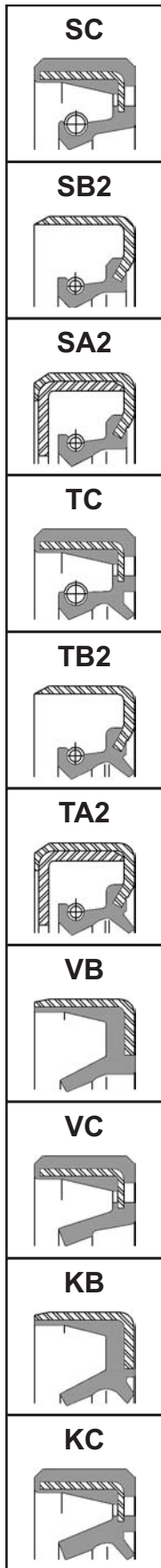







N.B.: MINIMUM LINE ORDER MAY APPLY

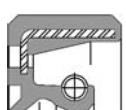

## GLOBAL AVAILABILITY LIST

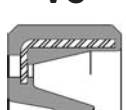
## RADIAL SHAFT SEALS - NBR/STEEL

**INCH SIZE  
SHAFT SEALS**

SC 	Ref. Number	Dimensions			DESIGN TYPE										
		d	D	H	SC	SB2	SA2	TC	TB2	TA2	VB	VC	KB	KC	
	S0156302062-203	1.563	2.062	0.203	•	•	•	•	•	•	•	•	•	X	•
	S0156302063-250	1.563	2.063	0.250	•	•	•	X	•	•	•	•	•	•	•
	S0156302125-313	1.563	2.125	0.313	•	•	•	X	•	•	•	•	•	•	•
	S0156302250-313	1.563	2.250	0.313	•	•	•	X	•	•	•	•	•	•	•
	S0156302270-338	1.563	2.270	0.338	•	•	•	•	•	•	•	X	•	•	•
	S0156302374-313	1.563	2.374	0.313	•	•	•	•	•	•	X	•	•	•	•
	S0156302441-500	1.563	2.441	0.500	•	•	•	•	•	•	X	•	•	•	•
	S0156302502-313	1.563	2.502	0.313	•	•	•	X	•	•	X	•	•	•	•
	S0156302561-313	1.563	2.561	0.313	•	•	•	X	•	•	•	•	•	•	•
	S0156302623-312	1.563	2.623	0.312	•	•	•	•	•	•	X	•	•	•	•
	S0156302686-313	1.563	2.686	0.313	•	•	•	X	•	•	•	•	•	•	•
	S0156302686-375	1.563	2.686	0.375	•	•	•	•	•	•	•	•	X	•	•
	S0156302750-500	1.563	2.750	0.500	•	•	X	•	•	•	•	•	•	•	•
	S0156302875-313	1.563	2.875	0.313	•	•	X	•	•	•	X	•	•	•	•
	S0156502624-515	1.565	2.624	0.515	•	•	•	•	•	•	•	X	•	•	•
	S0157502284-315	1.575	2.284	0.315	•	•	•	•	•	•	X	•	•	•	•
	S0157502441-394	1.575	2.441	0.394	X	•	•	•	•	•	•	•	•	•	•
	S0157802082-250	1.578	2.082	0.250	•	•	•	X	•	•	•	•	•	•	•
	S0157802408-313	1.578	2.408	0.313	•	•	•	•	•	X	•	•	•	•	•
	S0157802408-500	1.578	2.408	0.500	•	•	X	•	•	•	•	•	•	•	•
	S0159302437-468	1.593	2.437	0.468	•	•	X	•	•	•	•	•	•	•	•
	S0159302502-250	1.593	2.502	0.250	•	•	•	X	•	•	•	•	•	•	•
	S0159402125-250	1.594	2.125	0.250	•	•	•	X	•	•	•	•	•	•	•
	S0159402502-313	1.594	2.502	0.313	•	•	•	X	•	•	•	•	•	•	•
	S0159402758-313	1.594	2.758	0.313	•	•	•	X	•	•	•	•	•	•	•
	S0160602374-375	1.606	2.374	0.375	•	•	•	•	•	•	•	X	•	•	•
	S0161402205-273	1.614	2.205	0.273	•	•	•	•	X	•	•	•	•	•	•
	S0161802531-438	1.618	2.531	0.438	•	•	•	•	•	•	X	•	•	•	•
	S0161802575-500	1.618	2.575	0.500	•	•	•	•	•	•	X	•	•	•	•
	S0162502000-250	1.625	2.000	0.250	•	•	•	X	•	•	X	•	•	•	•
	S0162502116-312	1.625	2.116	0.312	•	•	•	•	•	•	X	•	•	•	•
	S0162502125-250	1.625	2.125	0.250	•	•	•	X	•	•	•	•	X	•	•
	S0162502250-313	1.625	2.250	0.313	•	•	•	X	•	•	X	•	•	•	•
	S0162502328-375	1.625	2.328	0.375	•	•	•	•	•	•	•	X	•	•	•
	S0162502328-438	1.625	2.328	0.438	•	•	•	•	•	•	•	•	X	•	•
	S0162502374-250	1.625	2.374	0.250	•	•	•	X	•	•	•	•	•	•	•
	S0162502374-313	1.625	2.374	0.313	•	•	X	X	•	•	X	•	•	•	•
	S0162502374-500	1.625	2.374	0.500	•	•	X	•	•	•	•	•	•	•	•
	S0162502375-375	1.625	2.375	0.375	•	•	•	•	•	•	•	•	X	•	•
	S0162502437-313	1.625	2.437	0.313	•	•	•	X	•	•	X	•	•	•	•
	S0162502441-313	1.625	2.441	0.313	•	•	•	•	•	•	X	•	•	•	•
	S0162502500-313	1.625	2.500	0.313	•	•	•	X	•	•	•	•	•	•	•
	S0162502502-313	1.625	2.502	0.313	•	•	•	X	•	•	X	•	•	•	•
	S0162502623-313	1.625	2.623	0.313	•	•	•	•	•	•	X	•	•	•	•
	S0162502686-375	1.625	2.686	0.375	•	•	•	X	•	•	•	•	•	•	•
	S0162502750-250	1.625	2.750	0.250	•	•	•	•	•	•	•	•	•	•	•
	S0162502750-312	1.625	2.750	0.312	•	•	•	•	•	•	X	•	•	•	•
	S0162502758-313	1.625	2.758	0.313	•	•	•	X	•	•	•	•	•	•	•

X: EXISTING TOOLING    •: ON REQUEST

N.B.: MINIMUM LINE ORDER MAY APPLY

**Tel.: (888) 238-5885**  
**Fax: (888) 238-1664**

**SS 29**

[www.sealsonline.com](http://www.sealsonline.com)



## RADIAL SHAFT SEALS - NBR/STEEL

## GLOBAL AVAILABILITY LIST

Ref. Number	Dimensions			DESIGN TYPE									SC
	d	D	H	SC	SB2	SA2	TC	TB2	TA2	VB	VC	KB	
S0162502835-468	1.625	2.835	0.468	•	•	X	•	•	•	•	•	•	•
S0162502875-313	1.625	2.875	0.313	•	•	•	X	•	•	X	•	•	•
S0162503000-312	1.625	3.000	0.312	•	•	•	•	•	X	•	•	•	•
S0162503000-313	1.625	3.000	0.313	•	•	X	•	•	•	•	•	•	•
S0165602937-375	1.656	2.937	0.375	•	•	•	•	•	•	X	•	•	•
S0166802712-375	1.668	2.712	0.375	•	•	•	•	•	•	X	•	•	•
S0167702124-188	1.677	2.124	0.188	•	•	•	•	X	•	•	•	•	•
S0168702374-312	1.687	2.374	0.312	•	•	•	•	•	•	X	•	•	•
S0168702437-312	1.687	2.437	0.312	•	•	•	•	•	•	X	•	•	•
S0168702502-312	1.687	2.502	0.312	•	•	•	•	•	•	X	•	•	•
S0168702561-500	1.687	2.561	0.500	•	•	•	•	•	•	X	X	•	•
S0168702750-312	1.687	2.750	0.312	•	•	•	•	•	•	X	•	•	•
S0168702835-468	1.687	2.835	0.468	•	•	•	•	•	•	X	•	•	•
S0168703000-375	1.687	3.000	0.375	•	•	•	•	•	•	X	•	•	•
S0168703125-500	1.687	3.125	0.500	•	•	•	•	•	•	X	•	•	•
S0168802166-313	1.688	2.166	0.313	•	X	•	•	•	•	•	•	•	•
S0168802328-313	1.688	2.328	0.313	•	•	•	•	•	•	X	•	•	•
S0168802437-313	1.688	2.437	0.313	•	•	•	X	•	•	•	•	•	•
S0168802502-312	1.688	2.502	0.312	•	•	•	•	•	•	X	•	•	•
S0168802623-500	1.688	2.623	0.500	•	•	•	X	•	•	•	•	•	•
S0168802623-531	1.688	2.623	0.531	•	•	•	•	•	•	X	•	•	•
S0168802712-375	1.688	2.712	0.375	•	•	•	•	•	•	X	•	•	•
S0168802750-375	1.688	2.750	0.375	•	•	•	•	•	•	X	•	•	•
S0168802875-469	1.688	2.875	0.469	•	•	•	•	•	•	X	•	•	•
S0171802623-500	1.718	2.623	0.500	•	•	X	•	•	•	•	•	•	•
S0171902561-500	1.719	2.561	0.500	•	•	•	•	•	•	X	X	X	•
S0173002336-250	1.730	2.336	0.250	X	•	•	•	•	•	•	•	•	•
S0173402401-210	1.734	2.401	0.210	•	•	•	•	•	•	•	•	X	•
S0175002125-188	1.750	2.125	0.188	•	•	•	X	•	•	•	•	•	•
S0175002250-187	1.750	2.250	0.187	•	•	•	•	X	•	•	•	•	•
S0175002250-188	1.750	2.250	0.188	•	•	•	X	•	•	•	•	X	•
S0175002250-313	1.750	2.250	0.313	•	•	X	X	•	•	•	•	•	•
S0175002318-375	1.750	2.318	0.375	•	•	•	•	•	•	X	•	•	•
S0175002328-312	1.750	2.328	0.312	•	•	•	•	•	•	•	•	X	•
S0175002328-437	1.750	2.328	0.437	•	•	•	X	•	•	•	•	•	•
S0175002346-500	1.750	2.346	0.500	•	•	•	•	•	•	•	X	•	•
S0175002356-500	1.750	2.356	0.500	•	•	•	•	•	•	•	X	•	•
S0175002374-313	1.750	2.374	0.313	•	•	•	•	•	•	X	•	•	•
S0175002437-313	1.750	2.437	0.313	•	•	•	X	•	•	X	•	•	•
S0175002438-312	1.750	2.438	0.312	•	•	•	•	•	•	•	X	•	•
S0175002441-313	1.750	2.441	0.313	•	•	•	X	•	•	X	•	•	•
S0175002449-312	1.750	2.449	0.312	•	•	•	•	•	•	X	•	•	•
S0175002502-313	1.750	2.502	0.313	•	•	•	•	•	•	X	•	•	•
S0175002561-312	1.750	2.561	0.312	•	•	•	•	•	•	X	•	•	•
S0175002561-313	1.750	2.561	0.313	•	•	•	X	•	•	•	•	•	•
S0175002565-313	1.750	2.565	0.313	•	•	•	•	•	•	X	•	•	•
S0175002623-313	1.750	2.623	0.313	•	•	•	•	•	•	X	•	•	•
S0175002686-375	1.750	2.686	0.375	•	•	•	X	•	•	X	•	•	•

X: EXISTING TOOLING •: ON REQUEST



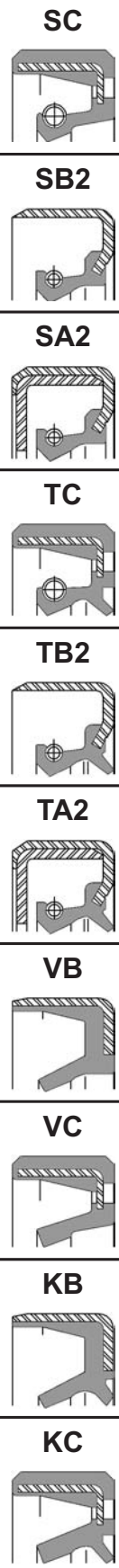







N.B.: MINIMUM LINE ORDER MAY APPLY



## GLOBAL AVAILABILITY LIST

## RADIAL SHAFT SEALS - NBR/STEEL

INCH SIZE  
SHAFT SEALS

SC 	Ref. Number	Dimensions			DESIGN TYPE									
		d	D	H	SC	SB2	SA2	TC	TB2	TA2	VB	VC	KB	KC
	S0175002686-500	1.750	2.686	0.500	•	•	•	•	•	•	X	•	•	•
	S0175002715-438	1.750	2.715	0.438	•	•	•	•	•	•	•	X	•	•
	S0175002717-438	1.750	2.717	0.438	•	•	•	•	•	•	X	•	•	•
	S0175002750-313	1.750	2.750	0.313	•	•	•	X	•	•	X	•	•	•
	S0175002756-375	1.750	2.756	0.375	•	•	•	•	X	•	•	•	•	•
	S0175002758-375	1.750	2.758	0.375	•	•	•	•	•	•	X	•	•	•
	S0175002810-313	1.750	2.810	0.313	•	•	•	•	•	•	X	•	•	•
	S0175002875-313	1.750	2.875	0.313	•	•	•	X	•	•	•	•	•	•
	S0175002875-500	1.750	2.875	0.500	•	•	X	•	•	•	•	•	•	•
	S0175002996-375	1.750	2.996	0.375	•	•	•	•	•	•	X	•	•	•
	S0175003000-313	1.750	3.000	0.313	•	•	•	X	•	•	•	•	•	•
	S0175003000-375	1.750	3.000	0.375	•	•	•	•	•	•	X	•	•	•
	S0175003061-313	1.750	3.061	0.313	•	•	•	X	•	•	•	•	•	•
	S0175003061-375	1.750	3.061	0.375	•	•	•	•	•	•	X	•	•	•
	S0175003189-313	1.750	3.189	0.313	•	•	•	X	•	•	•	•	•	•
	S0175003189-437	1.750	3.189	0.437	•	•	•	•	•	•	X	•	•	•
	S0175003543-438	1.750	3.543	0.438	•	•	•	X	•	•	•	•	•	•
	S0175003543-500	1.750	3.543	0.500	•	•	X	•	•	•	•	•	•	•
	S0175003937-312	1.750	3.937	0.312	•	•	•	•	•	•	X	•	•	•
	S0176202261-313	1.762	2.261	0.313	•	•	•	X	•	•	•	•	•	•
	S0177602416-375	1.776	2.416	0.375	•	•	•	•	•	•	X	•	•	•
	S0178102252-313	1.781	2.252	0.313	•	•	•	•	•	•	X	•	•	•
	S0178102502-312	1.781	2.502	0.312	•	•	X	•	•	•	•	•	•	•
	S0178102502-313	1.781	2.502	0.313	•	•	•	•	X	•	•	•	•	•
	S0178102623-313	1.781	2.623	0.313	•	•	•	X	•	•	•	•	•	•
	S0178302285-250	1.783	2.285	0.250	•	•	•	•	X	•	•	•	•	•
	S0179702726-516	1.797	2.726	0.516	•	•	•	•	•	•	•	•	X	•
	S0181102327-437	1.811	2.327	0.437	•	•	•	•	•	•	•	•	X	•
	S0181202437-468	1.812	2.437	0.468	•	•	X	•	•	•	•	•	•	•
	S0181202497-250	1.812	2.497	0.250	•	•	•	X	•	•	•	•	•	•
	S0181202686-375	1.812	2.686	0.375	•	•	•	•	•	•	X	•	•	•
	S0181202750-375	1.812	2.750	0.375	•	•	•	•	•	•	X	•	•	•
	S0181202875-375	1.812	2.875	0.375	•	•	•	•	•	•	X	•	•	•
	S0181203189-437	1.812	3.189	0.437	•	•	X	•	•	•	•	•	•	•
	S0181302437-315	1.813	2.437	0.315	•	•	•	X	•	•	•	•	•	•
	S0181302623-313	1.813	2.623	0.313	•	•	•	X	•	•	•	•	•	•
	S0181302750-313	1.813	2.750	0.313	•	•	•	X	•	•	•	•	•	•
	S0181302875-313	1.813	2.875	0.313	•	•	•	X	•	•	•	•	•	•
	S0181303001-563	1.813	3.001	0.563	•	•	•	•	•	•	X	•	•	•
	S0184302750-375	1.843	2.750	0.375	•	•	•	•	•	•	X	•	•	•
	S0187502125-375	1.875	2.125	0.375	•	•	•	•	•	•	X	•	•	•
	S0187502397-250	1.875	2.397	0.250	•	•	•	•	X	•	•	•	•	•
	S0187502398-250	1.875	2.398	0.250	•	•	•	•	•	•	•	X	•	•
	S0187502400-240	1.875	2.400	0.240	•	•	•	•	X	•	•	•	•	•
	S0187502471-313	1.875	2.471	0.313	•	•	•	•	•	•	X	•	•	•
	S0187502502-312	1.875	2.502	0.312	•	•	•	•	•	•	X	•	•	•
	S0187502502-313	1.875	2.502	0.313	•	•	•	X	•	•	•	•	•	•
	S0187502623-250	1.875	2.623	0.250	•	•	•	•	•	•	•	X	•	•

X: EXISTING TOOLING \* : ON REQUEST

N.B.: MINIMUM LINE ORDER MAY APPLY

Tel.: (204) 783-9617  
Fax: (204) 783-6091

**SS**

**31**

[www.sealsonline.com](http://www.sealsonline.com)





## RADIAL SHAFT SEALS - NBR/STEEL

## GLOBAL AVAILABILITY LIST

Ref. Number	Dimensions			DESIGN TYPE										SC
	d	D	H	SC	SB2	SA2	TC	TB2	TA2	VB	VC	KB	KC	
S0187502623-313	1.875	2.623	0.313	•	•	•	•	•	•	X	•	•	•	
S0187502628-328	1.875	2.628	0.328	•	•	•	•	•	•	•	•	X	•	
S0187502686-375	1.875	2.686	0.375	•	•	•	•	•	•	X	X	•	•	
S0187502750-312	1.875	2.750	0.312	•	•	•	X	•	X	•	•	•	•	
S0187502750-313	1.875	2.750	0.313	•	•	•	•	•	•	X	•	•	•	
S0187502758-375	1.875	2.758	0.375	•	•	•	•	•	•	X	•	•	•	
S0187502782-438	1.875	2.782	0.438	•	•	X	•	•	X	•	•	•	•	
S0187502835-375	1.875	2.835	0.375	•	•	•	•	•	•	X	•	•	•	
S0187502875-313	1.875	2.875	0.313	•	•	•	X	•	•	X	•	•	•	
S0187502877-375	1.875	2.877	0.375	•	•	•	•	•	•	X	•	•	•	
S0187502997-250	1.875	2.997	0.250	•	•	•	•	•	•	•	•	X	•	
S0187503000-312	1.875	3.000	0.312	•	•	•	•	•	•	X	•	•	•	
S0187503000-313	1.875	3.000	0.313	•	•	•	X	•	•	•	•	•	•	
S0187503000-500	1.875	3.000	0.500	•	•	•	•	•	•	•	•	X	•	
S0187503061-313	1.875	3.061	0.313	•	•	•	•	•	X	X	•	•	•	
S0187503125-312	1.875	3.125	0.312	•	•	•	•	•	•	X	•	•	•	
S0187503189-375	1.875	3.189	0.375	•	•	•	•	•	•	X	•	•	•	
S0187503189-469	1.875	3.189	0.469	•	•	X	•	•	•	•	•	•	•	
S0187503249-480	1.875	3.249	0.480	•	•	•	•	•	•	X	•	•	•	
S0187503251-500	1.875	3.251	0.500	•	•	X	•	•	•	•	•	•	•	
S0187503317-438	1.875	3.317	0.438	•	•	•	•	•	X	•	•	•	•	
S0189302434-250	1.893	2.434	0.250	•	•	•	X	•	•	•	•	•	•	
S0191502533-250	1.915	2.533	0.250	•	•	•	X	•	•	•	•	•	•	
S0193003543-375	1.930	3.543	0.375	•	•	•	•	•	X	•	•	•	•	
S0193702412-468	1.937	2.412	0.468	•	•	•	•	•	•	X	•	•	•	
S0193702437-250	1.937	2.437	0.250	•	•	•	•	•	•	X	•	•	•	
S0193702561-500	1.937	2.561	0.500	•	•	•	•	•	•	X	•	•	•	
S0193702620-250	1.937	2.620	0.250	•	•	•	•	•	•	•	X	•	•	
S0193702623-312	1.937	2.623	0.312	•	•	•	•	•	•	X	•	•	•	
S0193702625-250	1.937	2.625	0.250	•	•	•	•	•	•	•	X	•	•	
S0193702750-312	1.937	2.750	0.312	•	•	•	•	•	•	X	•	•	•	
S0193702758-500	1.937	2.758	0.500	•	•	X	•	•	•	•	•	•	•	
S0193702875-312	1.937	2.875	0.312	•	•	•	•	•	•	X	•	•	•	
S0193702996-375	1.937	2.996	0.375	•	•	•	•	•	•	X	•	•	•	
S0193703061-375	1.937	3.061	0.375	•	•	•	•	•	•	X	•	•	•	
S0193703061-500	1.937	3.061	0.500	•	•	X	•	•	•	•	•	•	•	
S0193703189-375	1.937	3.189	0.375	•	•	•	•	•	•	X	•	•	•	
S0193703250-375	1.937	3.250	0.375	•	•	•	•	•	•	•	X	•	•	
S0193703375-375	1.937	3.375	0.375	•	•	•	•	•	•	X	•	•	•	
S0193703543-375	1.937	3.543	0.375	•	•	•	•	•	X	•	•	•	•	
S0193703543-500	1.937	3.543	0.500	•	•	•	•	•	X	•	•	•	•	
S0193802437-250	1.938	2.437	0.250	•	•	•	X	•	•	•	•	•	•	
S0193802502-281	1.938	2.502	0.281	•	•	•	•	•	•	•	•	X	•	
S0193802502-375	1.938	2.502	0.375	•	•	•	•	•	•	X	•	•	•	
S0193802506-281	1.938	2.506	0.281	•	•	•	•	•	•	•	•	X	•	
S0193802623-313	1.938	2.623	0.313	•	•	•	X	•	•	•	•	•	•	
S0193802686-313	1.938	2.686	0.313	•	•	•	•	•	•	X	•	•	•	
S0193802750-313	1.938	2.750	0.313	•	•	•	X	•	•	•	•	•	•	

X: EXISTING TOOLING •: ON REQUEST



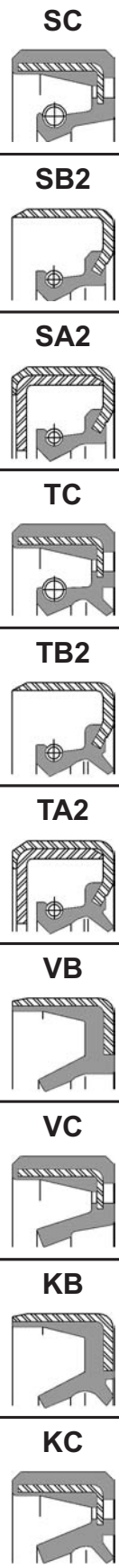







N.B.: MINIMUM LINE ORDER MAY APPLY

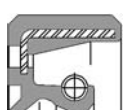

## GLOBAL AVAILABILITY LIST

## RADIAL SHAFT SEALS - NBR/STEEL

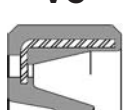
INCH SIZE  
SHAFT SEALS

SC 	Ref. Number	Dimensions			DESIGN TYPE									
		d	D	H	SC	SB2	SA2	TC	TB2	TA2	VB	VC	KB	KC
	S0193802997-313	1.938	2.997	0.313	•	•	•	X	•	•	•	•	•	•
	S0193803000-313	1.938	3.000	0.313	•	•	•	X	•	•	X	•	•	•
	S0193803061-313	1.938	3.061	0.313	•	•	•	X	•	•	•	•	•	•
	S0193803125-500	1.938	3.125	0.500	•	•	•	X	•	•	X	•	•	•
	S0193803251-313	1.938	3.251	0.313	•	•	•	X	•	•	•	•	•	•
	S0193803543-313	1.938	3.543	0.313	•	•	•	X	•	•	•	•	•	•
	S0196802686-500	1.968	2.686	0.500	•	•	X	•	•	•	•	•	•	•
	S0196802742-500	1.968	2.742	0.500	•	•	X	•	•	•	•	•	•	•
	S0196802875-468	1.968	2.875	0.468	•	•	X	•	•	•	•	•	•	•
	S0196902623-313	1.969	2.623	0.313	•	•	•	•	•	•	X	•	•	•
	S0196902742-500	1.969	2.742	0.500	•	•	X	•	•	•	•	•	•	•
	S0196902875-469	1.969	2.875	0.469	•	•	X	•	•	•	•	•	•	•
	S0198302502-281	1.983	2.502	0.281	•	•	•	•	•	•	•	•	X	•
	S0200002371-250	2.000	2.371	0.250	•	•	•	•	•	•	•	•	X	•
	S0200002502-250	2.000	2.502	0.250	•	•	•	•	X	•	•	X	X	•
	S0200002563-227	2.000	2.563	0.227	•	•	•	•	•	•	•	•	X	•
	S0200002565-500	2.000	2.565	0.500	•	•	•	•	•	•	•	•	X	•
	S0200002623-250	2.000	2.623	0.250	X	•	•	•	•	•	•	•	•	•
	S0200002623-313	2.000	2.623	0.313	•	•	•	X	•	•	X	•	•	•
	S0200002635-235	2.000	2.635	0.235	•	•	•	•	•	•	•	•	X	•
	S0200002686-375	2.000	2.686	0.375	•	•	•	X	•	•	X	•	•	•
	S0200002716-375	2.000	2.716	0.375	•	•	•	•	•	•	X	•	•	•
	S0200002745-230	2.000	2.745	0.230	•	•	•	•	•	•	•	•	X	•
	S0200002750-313	2.000	2.750	0.313	•	•	•	•	•	•	X	X	•	•
	S0200002750-500	2.000	2.750	0.500	•	•	X	X	•	•	•	•	•	•
	S0200002835-468	2.000	2.835	0.468	•	•	X	•	•	•	•	•	•	•
	S0200002875-313	2.000	2.875	0.313	•	•	•	X	•	X	•	•	•	•
	S0200002875-468	2.000	2.875	0.468	•	•	X	•	•	•	•	•	•	•
	S0200002875-500	2.000	2.875	0.500	•	•	X	•	•	•	•	X	•	•
	S0200002880-375	2.000	2.880	0.375	•	•	•	•	•	•	X	•	•	•
	S0200002965-313	2.000	2.965	0.313	•	•	•	•	•	•	•	•	X	•
	S0200002965-500	2.000	2.965	0.500	•	•	•	•	•	•	•	•	X	•
	S0200002968-313	2.000	2.968	0.313	•	•	•	•	•	•	•	•	X	•
	S0200002996-375	2.000	2.996	0.375	•	•	•	•	•	X	•	X	•	•
	S0200002997-375	2.000	2.997	0.375	•	•	X	•	•	•	•	•	•	•
	S0200003000-250	2.000	3.000	0.250	•	•	•	X	•	•	•	•	•	•
	S0200003000-313	2.000	3.000	0.313	•	•	•	•	•	•	X	•	•	•
	S0200003000-375	2.000	3.000	0.375	•	•	X	•	•	•	•	•	•	•
	S0200003061-500	2.000	3.061	0.500	•	•	X	•	•	X	•	•	•	•
	S0200003062-375	2.000	3.062	0.375	•	•	•	•	•	•	X	•	•	•
	S0200003125-312	2.000	3.125	0.312	•	•	•	•	•	•	X	•	•	•
	S0200003150-375	2.000	3.150	0.375	•	•	•	•	•	X	•	•	•	•
	S0200003189-375	2.000	3.189	0.375	•	•	•	•	•	•	X	•	•	•
	S0200003251-438	2.000	3.251	0.438	•	•	X	•	•	X	•	•	•	•
	S0200003350-468	2.000	3.350	0.468	•	•	•	•	•	X	•	•	•	•
	S0200003371-438	2.000	3.371	0.438	•	•	X	•	•	X	•	•	•	•
	S0200003500-500	2.000	3.500	0.500	•	•	•	•	•	X	•	•	•	•
	S0206202875-437	2.062	2.875	0.437	•	•	X	•	•	•	•	•	•	•

X: EXISTING TOOLING    •: ON REQUEST

N.B.: MINIMUM LINE ORDER MAY APPLY

Tel.: (780) 414-1871  
Fax: (780) 487-5419

**SS**

**33**

[www.sealsonline.com](http://www.sealsonline.com)



## RADIAL SHAFT SEALS - NBR/STEEL

## GLOBAL AVAILABILITY LIST

Ref. Number	Dimensions			DESIGN TYPE										SC
	d	D	H	SC	SB2	SA2	TC	TB2	TA2	VB	VC	KB	KC	
S0206202996-375	2.062	2.996	0.375	•	•	•	•	•	•	X	•	•	•	
S0206203000-375	2.062	3.000	0.375	•	•	•	•	•	•	X	•	•	•	
S0206203000-500	2.062	3.000	0.500	•	•	X	•	•	•	•	•	•	•	
S0206203190-437	2.062	3.190	0.437	•	•	•	•	•	X	•	•	•	•	
S0206302875-375	2.063	2.875	0.375	•	•	•	•	•	•	X	•	•	•	
S0206303000-313	2.063	3.000	0.313	•	•	•	•	•	•	•	•	X	•	
S0206303125-375	2.063	3.125	0.375	•	•	•	X	•	•	•	•	•	•	
S0206303189-375	2.063	3.189	0.375	•	•	•	X	•	•	•	•	•	•	
S0207202871-565	2.072	2.871	0.565	•	•	•	•	•	•	•	X	•	•	
S0209803160-375	2.098	3.160	0.375	•	•	•	•	X	•	•	•	•	•	
S0212502750-375	2.125	2.750	0.375	•	•	•	•	•	•	X	•	•	•	
S0212502750-500	2.125	2.750	0.500	•	•	•	•	•	•	X	•	•	•	
S0212502758-437	2.125	2.758	0.437	•	•	•	•	•	•	X	•	•	•	
S0212502763-250	2.125	2.763	0.250	•	•	•	X	•	•	•	•	•	•	
S0212502835-468	2.125	2.835	0.468	•	•	X	•	•	•	•	•	•	•	
S0212502875-250	2.125	2.875	0.250	•	•	•	•	•	•	•	•	X	•	
S0212502875-438	2.125	2.875	0.438	•	•	X	X	•	X	X	•	•	•	
S0212502891-251	2.125	2.891	0.251	•	•	•	•	•	•	•	•	X	•	
S0212502997-438	2.125	2.997	0.438	•	•	X	•	•	•	•	•	•	•	
S0212503000-250	2.125	3.000	0.250	•	•	•	•	•	•	•	•	X	•	
S0212503000-375	2.125	3.000	0.375	•	•	•	•	•	X	•	•	•	•	
S0212503061-500	2.125	3.061	0.500	•	•	•	X	•	X	X	•	•	•	
S0212503062-475	2.125	3.062	0.475	•	•	•	•	•	•	•	•	•	X	
S0212503125-375	2.125	3.125	0.375	•	•	•	•	•	•	X	•	•	•	
S0212503125-438	2.125	3.125	0.438	•	•	X	•	•	•	•	•	•	•	
S0212503189-375	2.125	3.189	0.375	•	•	•	•	•	•	X	•	•	•	
S0212503251-438	2.125	3.251	0.438	•	•	X	•	•	•	•	•	•	•	
S0212503264-500	2.125	3.264	0.500	•	•	•	•	•	•	X	•	•	•	
S0212503350-375	2.125	3.350	0.375	•	•	•	•	•	X	•	•	•	•	
S0212503371-313	2.125	3.371	0.313	•	•	•	•	•	•	X	•	•	•	
S0212503371-375	2.125	3.371	0.375	•	•	•	•	•	X	X	•	•	•	
S0212503371-438	2.125	3.371	0.438	•	•	X	•	•	•	•	•	•	•	
S0212503371-500	2.125	3.371	0.500	•	•	•	•	•	•	X	•	•	•	
S0212503372-375	2.125	3.372	0.375	•	•	•	•	•	•	•	•	X	•	
S0212503372-438	2.125	3.372	0.438	•	•	•	•	•	•	X	•	•	•	
S0212503500-375	2.125	3.500	0.375	•	•	•	•	•	X	•	•	•	•	
S0212503543-500	2.125	3.543	0.500	•	•	•	•	•	X	•	•	•	•	
S0212503623-468	2.125	3.623	0.468	•	•	X	•	•	•	•	•	•	•	
S0212503623-469	2.125	3.623	0.469	•	•	•	•	•	•	X	•	•	•	
S0215603189-437	2.156	3.189	0.437	•	•	X	•	•	•	•	•	•	•	
S0218003000-495	2.180	3.000	0.495	X	•	•	•	•	•	•	•	•	•	
S0218702835-468	2.187	2.835	0.468	•	•	•	•	•	•	X	•	•	•	
S0218703062-375	2.187	3.062	0.375	•	•	•	•	•	•	X	•	•	•	
S0218703147-687	2.187	3.147	0.687	•	•	•	•	•	•	X	•	•	•	
S0218703189-437	2.187	3.189	0.437	•	•	•	•	•	•	X	•	•	•	
S0218703251-375	2.187	3.251	0.375	•	•	•	•	•	•	X	•	•	•	
S0218703350-375	2.187	3.350	0.375	•	•	•	•	•	X	•	•	•	•	
S0218703371-375	2.187	3.371	0.375	•	•	•	•	•	X	•	•	•	•	

X: EXISTING TOOLING •: ON REQUEST



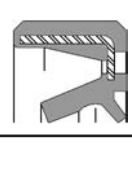
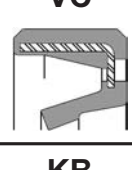
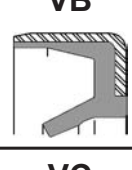
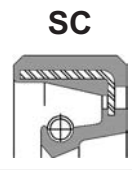







N.B.: MINIMUM LINE ORDER MAY APPLY



## GLOBAL AVAILABILITY LIST

## RADIAL SHAFT SEALS - NBR/STEEL

INCH SIZE  
SHAFT SEALS

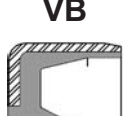
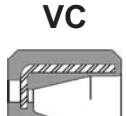
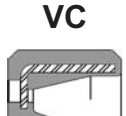
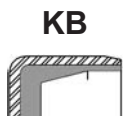
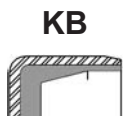
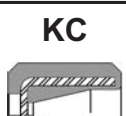
SC 	Ref. Number	Dimensions			DESIGN TYPE									
		d	D	H	SC	SB2	SA2	TC	TB2	TA2	VB	VC	KB	KC
	S0218703500-375	2.187	3.500	0.375	•	•	•	•	•	X	•	•	•	•
	S0218703623-468	2.187	3.623	0.468	•	•	•	•	•	X	•	•	•	•
	S0218704331-375	2.187	4.331	0.375	•	•	•	•	•	•	•	X	•	•
	S0218802875-375	2.188	2.875	0.375	•	•	•	•	•	•	X	•	•	•
	S0218803000-375	2.188	3.000	0.375	•	•	•	•	•	•	X	•	•	•
	S0218803251-438	2.188	3.251	0.438	•	•	X	•	•	•	•	•	•	•
	S0218803350-438	2.188	3.350	0.438	•	•	X	•	•	•	•	•	•	•
	S0221503000-375	2.215	3.000	0.375	•	•	•	X	•	•	•	•	•	•
	S0225002625-188	2.250	2.625	0.188	•	•	•	•	•	•	•	•	X	•
	S0225002997-438	2.250	2.997	0.438	•	•	•	•	•	X	•	•	•	•
	S0225003000-250	2.250	3.000	0.250	•	•	•	•	•	X	•	•	•	•
	S0225003000-375	2.250	3.000	0.375	•	•	•	X	•	•	X	•	•	•
	S0225003000-438	2.250	3.000	0.438	•	•	•	•	•	X	•	•	•	•
	S0225003061-375	2.250	3.061	0.375	•	•	•	X	•	•	X	•	•	•
	S0225003061-438	2.250	3.061	0.438	•	•	X	•	•	•	•	•	•	•
	S0225003061-500	2.250	3.061	0.500	•	•	•	•	•	X	•	•	•	•
	S0225003125-375	2.250	3.125	0.375	•	•	•	•	•	X	X	•	•	•
	S0225003189-437	2.250	3.189	0.437	•	•	•	•	•	X	•	•	•	•
	S0225003251-375	2.250	3.251	0.375	•	•	•	X	•	•	X	•	•	•
	S0225003251-438	2.250	3.251	0.438	•	•	X	•	•	X	•	•	•	•
	S0225003251-500	2.250	3.251	0.500	•	•	X	•	•	•	•	•	•	•
	S0225003264-312	2.250	3.264	0.312	•	•	•	•	•	•	X	•	•	•
	S0225003350-375	2.250	3.350	0.375	•	•	•	•	•	X	•	•	•	•
	S0225003350-438	2.250	3.350	0.438	•	•	X	•	•	•	•	•	•	•
	S0225003371-375	2.250	3.371	0.375	•	•	•	•	•	•	•	X	X	•
	S0225003371-438	2.250	3.371	0.438	•	•	•	•	•	X	•	•	•	•
	S0225003440-250	2.250	3.440	0.250	•	•	•	•	•	•	•	•	X	•
	S0225003500-438	2.250	3.500	0.438	•	•	•	•	•	X	•	•	•	•
	S0225003543-500	2.250	3.543	0.500	•	•	•	•	•	X	•	•	•	•
	S0225003623-468	2.250	3.623	0.468	•	•	•	•	•	X	•	•	•	•
	S0225003751-438	2.250	3.751	0.438	•	•	X	•	•	•	•	•	•	•
	S0225003751-500	2.250	3.751	0.500	•	•	•	•	•	X	•	•	•	•
	S0225003814-250	2.250	3.814	0.250	•	•	•	•	•	•	X	•	•	•
	S0225003876-438	2.250	3.876	0.438	•	•	X	•	•	•	•	•	•	•
	S0225004003-438	2.250	4.003	0.438	•	•	X	•	•	•	•	•	•	•
	S0228103155-375	2.281	3.155	0.375	X	•	•	•	•	•	•	•	•	•
	S0231203125-375	2.312	3.125	0.375	•	•	•	•	•	•	X	•	•	•
	S0231203251-375	2.312	3.251	0.375	•	•	•	•	•	X	•	•	•	•
	S0231203350-375	2.312	3.350	0.375	•	•	•	•	•	X	•	•	•	•
	S0231203371-468	2.312	3.371	0.468	•	•	X	•	•	•	•	•	•	•
	S0231203500-375	2.312	3.500	0.375	•	•	•	•	•	X	•	•	•	•
	S0231303000-250	2.313	3.000	0.250	•	•	•	•	•	•	•	•	X	•
	S0231303125-375	2.313	3.125	0.375	•	•	•	X	•	•	•	•	•	•
	S0231303251-438	2.313	3.251	0.438	•	•	X	•	•	•	•	•	•	•
	S0231303371-438	2.313	3.371	0.438	•	•	•	X	•	•	•	•	•	•
	S0231303500-313	2.313	3.500	0.313	•	•	•	X	•	•	•	•	•	•
	S0231303500-500	2.313	3.500	0.500	•	•	X	•	•	•	•	•	•	•
	S0231303751-500	2.313	3.751	0.500	•	•	•	X	•	•	•	•	•	•

X: EXISTING TOOLING    •: ON REQUEST

N.B.: MINIMUM LINE ORDER MAY APPLY

**Tel.: (604) 278-6808**  
**Fax: (604) 278-6180**

**SS      35**

[www.sealsonline.com](http://www.sealsonline.com)



## RADIAL SHAFT SEALS - NBR/STEEL

## GLOBAL AVAILABILITY LIST

Ref. Number	Dimensions			DESIGN TYPE									SC
	d	D	H	SC	SB2	SA2	TC	TB2	TA2	VB	VC	KB	
S0232803000-312	2.328	3.000	0.312	X	.	.	.	.	.	.	.	.	.
S0233002997-312	2.330	2.997	0.312	X	.	.	.	.	.	.	.	.	.
S0237502996-500	2.375	2.996	0.500	.	.	.	.	.	.	X	.	.	.
S0237503000-250	2.375	3.000	0.250	.	.	.	.	.	.	.	.	.	X
S0237503000-375	2.375	3.000	0.375	.	.	.	.	.	.	X	.	.	.
S0237503061-375	2.375	3.061	0.375	.	.	.	.	.	.	X	.	.	.
S0237503061-438	2.375	3.061	0.438	.	.	X	.	.	.	.	.	.	.
S0237503125-375	2.375	3.125	0.375	.	.	.	X	.	.	X	.	.	.
S0237503125-438	2.375	3.125	0.438	.	.	.	.	.	X	.	.	.	.
S0237503189-375	2.375	3.189	0.375	.	.	.	.	.	.	X	.	.	.
S0237503251-374	2.375	3.251	0.374	.	.	.	.	.	.	X	.	.	.
S0237503251-375	2.375	3.251	0.375	.	.	.	.	.	X	.	.	.	.
S0237503251-453	2.375	3.251	0.453	.	.	.	X	.	.	.	.	.	.
S0237503350-375	2.375	3.350	0.375	.	.	.	.	.	X	.	.	.	.
S0237503350-469	2.375	3.350	0.469	.	.	.	.	.	X	.	.	.	.
S0237503371-438	2.375	3.371	0.438	.	.	X	.	.	X	.	.	.	.
S0237503481-438	2.375	3.481	0.438	.	.	X	.	.	X	.	.	.	.
S0237503481-663	2.375	3.481	0.663	.	.	.	.	.	X	.	.	.	.
S0237503500-375	2.375	3.500	0.375	.	.	X	.	.	.	.	.	.	.
S0237503543-375	2.375	3.543	0.375	.	.	.	.	.	X	.	.	.	.
S0237503543-468	2.375	3.543	0.468	.	.	.	.	.	.	.	X	.	.
S0237503601-437	2.375	3.601	0.437	.	.	.	.	.	X	.	.	.	.
S0237503623-359	2.375	3.623	0.359	.	.	.	X	.	.	X	.	.	.
S0237503623-375	2.375	3.623	0.375	.	.	.	.	.	X	.	.	.	.
S0237503625-438	2.375	3.625	0.438	.	.	X	.	.	.	.	.	.	.
S0237503751-500	2.375	3.751	0.500	.	.	.	.	.	X	.	.	.	.
S0237503876-375	2.375	3.876	0.375	.	.	.	.	.	X	.	.	.	.
S0237503876-438	2.375	3.876	0.438	.	.	X	.	.	.	.	.	.	.
S0243703125-375	2.437	3.125	0.375	.	.	.	.	.	.	X	.	.	.
S0243703251-437	2.437	3.251	0.437	.	.	.	.	.	X	.	.	.	.
S0243703350-375	2.437	3.350	0.375	.	.	.	.	.	X	.	.	.	.
S0243703371-375	2.437	3.371	0.375	.	.	.	.	.	X	.	.	.	.
S0243703371-418	2.437	3.371	0.418	.	.	.	.	.	X	.	.	.	.
S0243703543-375	2.437	3.543	0.375	.	.	.	.	.	X	.	.	.	.
S0243803125-380	2.438	3.125	0.380	.	.	.	X	.	.	.	.	.	.
S0243803251-438	2.438	3.251	0.438	.	.	X	.	.	.	.	.	.	.
S0243803350-375	2.438	3.350	0.375	.	.	.	.	.	.	X	.	.	.
S0243803371-438	2.438	3.371	0.438	.	.	X	.	.	.	.	.	.	.
S0243803500-438	2.438	3.500	0.438	.	.	X	.	.	.	.	.	.	.
S0249703245-420	2.497	3.245	0.420	.	.	.	.	.	.	.	.	X	.
S0250003000-250	2.500	3.000	0.250	.	.	.	.	.	.	.	.	X	.
S0250003189-375	2.500	3.189	0.375	.	.	.	.	.	.	X	.	.	.
S0250003245-438	2.500	3.245	0.438	.	.	X	.	.	.	.	.	.	.
S0250003247-500	2.500	3.247	0.500	.	.	.	.	.	X	.	.	.	.
S0250003251-250	2.500	3.251	0.250	.	.	.	.	.	.	.	.	X	.
S0250003251-375	2.500	3.251	0.375	.	.	.	.	.	.	X	.	.	.
S0250003251-438	2.500	3.251	0.438	.	.	X	.	.	X	.	.	.	.
S0250003350-438	2.500	3.350	0.438	.	.	X	.	.	.	.	.	.	.

X: EXISTING TOOLING    •: ON REQUEST



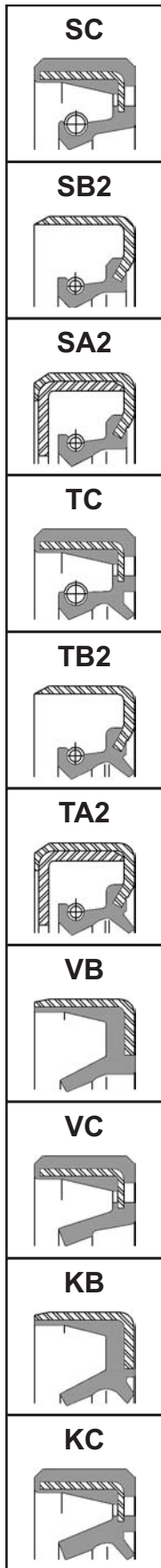









N.B.: MINIMUM LINE ORDER MAY APPLY

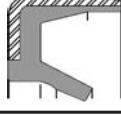
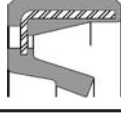

## GLOBAL AVAILABILITY LIST

## RADIAL SHAFT SEALS - NBR/STEEL

INCH SIZE  
SHAFT SEALS

SC 	Ref. Number	Dimensions			DESIGN TYPE									
		d	D	H	SC	SB2	SA2	TC	TB2	TA2	VB	VC	KB	KC
	S0250003350-468	2.500	3.350	0.468	•	•	•	•	•	X	•	•	•	•
	S0250003371-375	2.500	3.371	0.375	•	•	•	•	•	•	X	•	•	•
	S0250003371-438	2.500	3.371	0.438	•	•	X	•	•	•	•	•	•	•
	S0250003428-375	2.500	3.428	0.375	•	•	•	•	•	•	X	•	•	•
	S0250003500-375	2.500	3.500	0.375	•	•	•	•	•	X	X	•	•	•
	S0250003500-406	2.500	3.500	0.406	•	•	•	X	•	•	•	•	•	•
	S0250003500-438	2.500	3.500	0.438	•	•	X	•	•	X	X	•	•	•
	S0250003500-500	2.500	3.500	0.500	•	•	•	•	X	•	•	•	•	•
	S0250003543-438	2.500	3.543	0.438	•	•	X	•	•	•	•	•	•	•
	S0250003543-500	2.500	3.543	0.500	•	•	•	•	•	X	•	•	•	•
	S0250003623-375	2.500	3.623	0.375	•	•	X	X	•	•	X	•	•	•
	S0250003623-438	2.500	3.623	0.438	•	•	X	•	•	•	•	•	•	•
	S0250003751-438	2.500	3.751	0.438	•	•	X	•	•	X	•	•	•	•
	S0250003876-468	2.500	3.876	0.468	•	•	•	•	•	X	•	•	•	•
	S0250004003-375	2.500	4.003	0.375	•	•	•	•	•	•	X	•	•	•
	S0250004003-468	2.500	4.003	0.468	•	•	X	•	•	•	•	•	•	•
	S0255603937-375	2.556	3.937	0.375	•	•	•	•	•	•	X	•	•	•
	S0256203623-375	2.562	3.623	0.375	•	•	•	•	•	X	•	•	•	•
	S0256203750-375	2.562	3.750	0.375	•	•	•	•	•	X	•	•	•	•
	S0256303481-500	2.563	3.481	0.500	•	•	•	•	•	X	•	•	•	•
	S0256303500-438	2.563	3.500	0.438	•	•	X	•	•	•	•	•	•	•
	S0256303623-438	2.563	3.623	0.438	•	•	X	•	•	•	•	•	•	•
	S0256303632-500	2.563	3.632	0.500	•	•	•	•	•	X	•	•	•	•
	S0256303751-438	2.563	3.751	0.438	•	•	X	•	•	•	•	•	•	•
	S0256303876-438	2.563	3.876	0.438	•	•	X	•	•	•	•	•	•	•
	S0259803481-500	2.598	3.481	0.500	•	•	•	•	•	X	•	•	•	•
	S0259804000-500	2.598	4.000	0.500	•	•	•	•	•	•	X	•	•	•
	S0262503251-438	2.625	3.251	0.438	•	•	X	•	•	•	•	•	•	•
	S0262503350-375	2.625	3.350	0.375	•	•	•	•	•	X	•	•	•	•
	S0262503371-375	2.625	3.371	0.375	•	•	X	•	•	X	•	•	•	•
	S0262503371-438	2.625	3.371	0.438	•	•	•	•	•	X	•	•	•	•
	S0262503374-438	2.625	3.374	0.438	•	•	•	•	•	X	•	•	•	•
	S0262503481-438	2.625	3.481	0.438	•	•	•	•	•	X	•	•	•	•
	S0262503481-500	2.625	3.481	0.500	•	•	X	•	•	•	•	•	•	•
	S0262503500-375	2.625	3.500	0.375	•	•	•	•	•	•	X	•	•	•
	S0262503500-438	2.625	3.500	0.438	•	•	X	•	•	•	•	•	•	•
	S0262503623-375	2.625	3.623	0.375	•	•	•	•	•	X	X	•	•	•
	S0262503623-438	2.625	3.623	0.438	•	•	•	•	•	X	•	•	•	•
	S0262503624-468	2.625	3.624	0.468	•	•	X	•	•	•	•	•	•	•
	S0262503751-375	2.625	3.751	0.375	•	•	•	•	•	X	•	•	•	•
	S0262503876-438	2.625	3.876	0.438	•	•	X	•	•	•	•	•	•	•
	S0262503876-468	2.625	3.876	0.468	•	•	•	•	•	X	•	•	•	•
	S0262503936-438	2.625	3.936	0.438	•	•	X	•	•	•	•	•	•	•
	S0262504003-375	2.625	4.003	0.375	•	•	•	•	•	X	•	•	•	•
	S0262504249-468	2.625	4.249	0.468	•	•	•	•	•	X	•	•	•	•
	S0262504370-438	2.625	4.370	0.438	•	•	•	•	•	X	•	•	•	•
	S0262504437-437	2.625	4.437	0.437	•	•	•	•	•	X	•	•	•	•
	S0262504438-438	2.625	4.438	0.438	•	•	X	•	•	•	•	•	•	•

X: EXISTING TOOLING    •: ON REQUEST

N.B.: MINIMUM LINE ORDER MAY APPLY

Tel.: (418) 688-3202  
Fax: (418) 688-4272

**SS 37**

[www.sealsonline.com](http://www.sealsonline.com)



## RADIAL SHAFT SEALS - NBR/STEEL

## GLOBAL AVAILABILITY LIST

Ref. Number	Dimensions			DESIGN TYPE									SC
	d	D	H	SC	SB2	SA2	TC	TB2	TA2	VB	VC	KB	
S0268703500-500	2.687	3.500	0.500	•	•	X	•	•	•	•	•	•	•
S0268703876-468	2.687	3.876	0.468	•	•	X	•	•	•	•	•	•	•
S0268803500-375	2.688	3.500	0.375	•	•	•	•	•	•	•	•	X	•
S0268803751-438	2.688	3.751	0.438	•	•	•	•	•	•	X	•	•	•
S0268803876-438	2.688	3.876	0.438	•	•	X	•	•	•	•	•	•	•
S0275003481-438	2.750	3.481	0.438	•	•	•	•	•	•	X	•	•	•
S0275003500-250	2.750	3.500	0.250	•	•	•	•	•	•	•	•	X	•
S0275003500-375	2.750	3.500	0.375	•	•	•	X	•	X	X	•	•	•
S0275003500-438	2.750	3.500	0.438	•	•	X	•	•	•	•	•	•	•
S0275003538-437	2.750	3.538	0.437	•	•	X	•	•	•	•	•	•	•
S0275003543-375	2.750	3.543	0.375	•	•	•	•	•	X	•	•	•	•
S0275003623-375	2.750	3.623	0.375	•	•	•	•	•	X	•	•	•	•
S0275003623-438	2.750	3.623	0.438	•	•	X	•	•	•	•	•	•	•
S0275003751-375	2.750	3.751	0.375	•	•	•	•	•	X	•	•	•	•
S0275003751-438	2.750	3.751	0.438	•	•	X	•	•	X	X	•	•	•
S0275003765-438	2.750	3.765	0.438	•	•	X	•	•	•	•	•	•	•
S0275003876-375	2.750	3.876	0.375	•	•	•	•	•	•	X	•	•	•
S0275003876-438	2.750	3.876	0.438	•	•	X	•	•	X	X	•	•	•
S0275003936-438	2.750	3.936	0.438	•	•	X	•	•	•	•	•	•	•
S0281203500-375	2.812	3.500	0.375	•	•	•	X	•	•	•	•	•	•
S0281204249-468	2.812	4.249	0.468	•	•	•	•	•	X	•	•	•	•
S0281303751-438	2.813	3.751	0.438	•	•	•	•	•	•	X	•	•	•
S0281303876-438	2.813	3.876	0.438	•	•	X	•	•	•	•	•	•	•
S0281304003-438	2.813	4.003	0.438	•	•	X	•	•	•	•	•	•	•
S0281304249-438	2.813	4.249	0.438	•	•	X	•	•	•	•	•	•	•
S0284403939-500	2.844	3.939	0.500	•	•	•	•	•	X	•	•	•	•
S0287503623-375	2.875	3.623	0.375	•	•	•	•	•	•	X	•	•	•
S0287503623-438	2.875	3.623	0.438	•	•	X	•	•	•	•	•	•	•
S0287503751-375	2.875	3.751	0.375	•	•	•	•	•	X	•	•	•	•
S0287503751-438	2.875	3.751	0.438	•	•	X	•	•	X	•	•	•	•
S0287503876-375	2.875	3.876	0.375	•	•	•	•	•	X	•	•	•	•
S0287503876-438	2.875	3.876	0.438	•	•	•	•	•	X	•	•	•	•
S0287504003-375	2.875	4.003	0.375	•	•	•	•	•	X	•	•	•	•
S0287504003-438	2.875	4.003	0.438	•	•	•	•	•	X	•	•	•	•
S0287504125-375	2.875	4.125	0.375	•	•	•	•	•	X	•	•	•	•
S0287504249-500	2.875	4.249	0.500	•	•	•	•	•	X	•	•	•	•
S0287504501-438	2.875	4.501	0.438	•	•	X	•	•	•	•	•	•	•
S0287504625-437	2.875	4.625	0.437	•	•	•	•	•	X	•	•	•	•
S0290103601-232	2.901	3.601	0.232	•	•	•	•	X	•	•	•	•	•
S0292503940-500	2.925	3.940	0.500	•	•	•	•	•	•	X	•	•	•
S0293703751-375	2.937	3.751	0.375	•	•	•	•	•	X	•	•	•	•
S0293703937-500	2.937	3.937	0.500	•	•	•	•	•	X	•	•	•	•
S0293704003-375	2.937	4.003	0.375	•	•	•	•	•	X	•	•	•	•
S0293704499-468	2.937	4.499	0.468	•	•	•	•	•	X	•	•	•	•
S0293803751-375	2.938	3.751	0.375	•	•	•	•	•	•	X	•	•	•
S0293803875-375	2.938	3.875	0.375	•	•	•	•	•	X	•	•	•	•
S0293804000-438	2.938	4.000	0.438	•	•	•	•	•	X	•	•	•	•
S0293804003-438	2.938	4.003	0.438	•	•	•	•	•	X	•	•	•	•

X: EXISTING TOOLING •: ON REQUEST



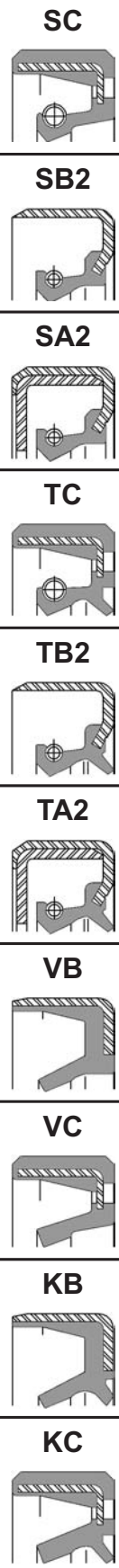







N.B.: MINIMUM LINE ORDER MAY APPLY

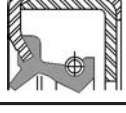

## GLOBAL AVAILABILITY LIST

## RADIAL SHAFT SEALS - NBR/STEEL

INCH SIZE  
SHAFT SEALS

SC 	Ref. Number	Dimensions			DESIGN TYPE									
		d	D	H	SC	SB2	SA2	TC	TB2	TA2	VB	VC	KB	KC
	S0293804125-375	2.938	4.125	0.375	•	•	X	•	•	X	•	•	•	•
	S0293804501-438	2.938	4.501	0.438	•	•	X	•	•	•	•	•	•	•
	S0295004187-500	2.950	4.187	0.500	•	•	•	•	•	•	•	X	•	•
	S0295004527-375	2.950	4.527	0.375	•	•	•	•	•	•	•	X	•	•
	S0298303875-375	2.983	3.875	0.375	•	•	•	•	•	X	•	•	•	•
	S0300003751-375	3.000	3.751	0.375	•	•	•	X	•	X	X	•	•	•
	S0300003751-438	3.000	3.751	0.438	•	•	•	•	•	X	•	•	•	•
	S0300003876-437	3.000	3.876	0.437	•	•	•	•	•	X	•	•	•	•
	S0300003876-438	3.000	3.876	0.438	•	•	X	•	•	•	•	•	•	•
	S0300003999-437	3.000	3.999	0.437	•	•	X	•	•	•	•	•	•	•
	S0300004003-375	3.000	4.003	0.375	•	•	•	•	•	X	X	•	•	•
	S0300004003-438	3.000	4.003	0.438	•	•	X	•	•	X	•	•	•	•
	S0300004125-437	3.000	4.125	0.437	•	•	•	•	•	X	•	•	•	•
	S0300004125-438	3.000	4.125	0.438	•	•	X	•	•	•	•	•	•	•
	S0300004249-437	3.000	4.249	0.437	•	•	•	•	•	X	•	•	•	•
	S0300004249-438	3.000	4.249	0.438	•	•	X	•	•	•	X	•	•	•
	S0300004331-438	3.000	4.331	0.438	•	•	X	•	•	•	•	•	•	•
	S0300004331-500	3.000	4.331	0.500	•	•	•	•	•	X	•	•	•	•
	S0300004376-438	3.000	4.376	0.438	•	•	•	•	•	X	•	•	•	•
	S0300004376-500	3.000	4.376	0.500	•	•	•	•	•	X	•	•	•	•
	S0300004500-438	3.000	4.500	0.438	•	•	X	•	•	X	•	•	•	•
	S0300004751-625	3.000	4.751	0.625	•	•	•	•	•	X	•	•	•	•
	S0300004999-438	3.000	4.999	0.438	•	•	•	•	•	X	•	•	•	•
	S0300004999-468	3.000	4.999	0.468	•	•	X	•	•	•	•	•	•	•
	S0312504003-375	3.125	4.003	0.375	•	•	•	•	•	X	X	•	•	•
	S0312504003-438	3.125	4.003	0.438	•	•	•	•	•	X	•	•	•	•
	S0312504125-250	3.125	4.125	0.250	X	•	•	•	•	•	•	•	•	•
	S0312504125-375	3.125	4.125	0.375	•	•	•	•	•	X	•	•	•	•
	S0312504125-438	3.125	4.125	0.438	•	•	X	•	•	•	•	•	•	•
	S0312504125-562	3.125	4.125	0.562	•	•	•	•	•	X	•	•	•	•
	S0312504174-290	3.125	4.174	0.290	X	•	•	•	•	•	•	•	•	•
	S0312504249-438	3.125	4.249	0.438	•	•	•	•	•	X	•	•	•	•
	S0312504375-500	3.125	4.375	0.500	•	•	•	•	•	X	•	•	•	•
	S0312504500-500	3.125	4.500	0.500	•	•	•	•	•	X	•	•	•	•
	S0312504501-438	3.125	4.501	0.438	•	•	X	•	•	•	•	•	•	•
	S0312504626-437	3.125	4.626	0.437	•	•	•	•	•	X	•	•	•	•
	S0312504626-438	3.125	4.626	0.438	•	•	X	•	•	•	•	•	•	•
	S0312504751-500	3.125	4.751	0.500	•	•	•	•	•	X	•	•	•	•
	S0312504751-625	3.125	4.751	0.625	•	•	X	•	•	•	•	•	•	•
	S0312504999-438	3.125	4.999	0.438	•	•	X	•	•	•	•	•	•	•
	S0312504999-468	3.125	4.999	0.468	•	•	•	•	•	X	•	•	•	•
	S0312505000-468	3.125	5.000	0.468	•	•	X	•	•	•	•	•	•	•
	S0312505251-438	3.125	5.251	0.438	•	•	•	•	•	X	•	•	•	•
	S0315004249-438	3.150	4.249	0.438	•	•	X	•	•	•	•	•	•	•
	S0318704249-468	3.187	4.249	0.468	•	•	X	•	•	•	•	•	•	•
	S0318804249-438	3.188	4.249	0.438	•	•	X	•	•	•	•	•	•	•
	S0318804501-438	3.188	4.501	0.438	•	•	X	•	•	•	•	•	•	•
	S0318804626-438	3.188	4.626	0.438	•	•	•	•	•	X	•	•	•	•

X: EXISTING TOOLING    •: ON REQUEST

N.B.: MINIMUM LINE ORDER MAY APPLY

Tel.: (514) 334-2220  
Fax: (514) 333-8329

**SS**

**39**

[www.sealsonline.com](http://www.sealsonline.com)





## RADIAL SHAFT SEALS - NBR/STEEL

## GLOBAL AVAILABILITY LIST

Ref. Number	Dimensions			DESIGN TYPE										SC
	d	D	H	SC	SB2	SA2	TC	TB2	TA2	VB	VC	KB	KC	
S0318804999-438	3.188	4.999	0.438	•	•	X	•	•	•	•	•	•	•	
S0318904626-438	3.189	4.626	0.438	•	•	•	•	•	•	X	•	•	•	
S0325004003-375	3.250	4.003	0.375	•	•	•	•	•	X	•	•	•	•	
S0325004003-468	3.250	4.003	0.468	•	•	•	•	•	X	•	•	•	•	
S0325004249-250	3.250	4.249	0.250	•	•	•	•	•	•	•	•	X	•	
S0325004249-375	3.250	4.249	0.375	•	•	•	•	•	•	X	•	•	•	
S0325004249-438	3.250	4.249	0.438	•	•	•	•	•	X	•	•	•	•	
S0325004376-438	3.250	4.376	0.438	•	•	•	•	•	X	•	•	•	•	
S0325004376-500	3.250	4.376	0.500	•	•	•	•	•	X	•	•	•	•	
S0325004500-375	3.250	4.500	0.375	•	•	•	•	•	X	•	•	•	•	
S0325004501-438	3.250	4.501	0.438	•	•	•	•	•	X	•	•	•	•	
S0325004626-438	3.250	4.626	0.438	•	•	X	•	•	•	•	•	•	•	
S0325004626-500	3.250	4.626	0.500	•	•	•	•	•	X	•	•	•	•	
S0325004723-468	3.250	4.723	0.468	•	•	•	•	•	X	•	•	•	•	
S0325004751-438	3.250	4.751	0.438	•	•	•	•	•	X	•	•	•	•	
S0325004751-484	3.250	4.751	0.484	•	•	X	•	•	•	•	•	•	•	
S0325004999-438	3.250	4.999	0.438	•	•	•	•	•	X	•	•	•	•	
S0325004999-468	3.250	4.999	0.468	•	•	•	•	•	X	•	•	•	•	
S0329804125-562	3.298	4.125	0.562	•	•	X	•	•	•	•	•	•	•	
S0331204249-500	3.312	4.249	0.500	•	•	•	•	•	X	•	•	•	•	
S0331204376-500	3.312	4.376	0.500	•	•	•	•	•	X	•	•	•	•	
S0331204499-468	3.312	4.499	0.468	•	•	•	•	•	X	•	•	•	•	
S0331204751-500	3.312	4.751	0.500	•	•	•	•	•	X	•	•	•	•	
S0331304500-468	3.313	4.500	0.468	•	•	X	•	•	•	•	•	•	•	
S0331304999-438	3.313	4.999	0.438	•	•	X	•	•	•	•	•	•	•	
S0331305130-500	3.313	5.130	0.500	•	•	X	•	•	•	•	•	•	•	
S0337504125-375	3.375	4.125	0.375	•	•	•	•	•	X	X	•	•	•	
S0337504249-500	3.375	4.249	0.500	•	•	•	•	•	X	•	•	•	•	
S0337504376-375	3.375	4.376	0.375	•	•	•	•	•	X	•	•	•	•	
S0337504376-438	3.375	4.376	0.438	•	•	•	•	•	X	•	•	•	•	
S0337504376-625	3.375	4.376	0.625	•	•	X	•	•	•	•	•	•	•	
S0337504501-438	3.375	4.501	0.438	•	•	X	•	•	X	•	•	•	•	
S0337504625-500	3.375	4.625	0.500	•	•	X	•	•	•	•	•	•	•	
S0337504626-438	3.375	4.626	0.438	•	•	X	•	•	X	•	•	•	•	
S0337504686-438	3.375	4.686	0.438	•	•	X	•	•	•	•	•	•	•	
S0337504688-500	3.375	4.688	0.500	•	•	X	•	•	•	•	•	•	•	
S0337504999-438	3.375	4.999	0.438	•	•	•	•	•	X	•	•	•	•	
S0337504999-468	3.375	4.999	0.468	•	•	•	•	•	X	•	•	•	•	
S0343704249-375	3.437	4.249	0.375	•	•	•	•	•	X	•	•	•	•	
S0343704626-500	3.437	4.626	0.500	•	•	•	•	•	X	•	•	•	•	
S0343704999-468	3.437	4.999	0.468	•	•	X	•	•	•	•	•	•	•	
S0343705250-468	3.437	5.250	0.468	•	•	X	•	•	•	•	•	•	•	
S0343804249-375	3.438	4.249	0.375	•	•	•	X	•	•	•	•	•	•	
S0343804501-375	3.438	4.501	0.375	•	•	•	•	•	X	•	•	•	•	
S0343804501-438	3.438	4.501	0.438	•	•	•	•	•	X	•	•	•	•	
S0343804756-438	3.438	4.756	0.438	•	•	X	•	•	•	•	•	•	•	
S0343804876-438	3.438	4.876	0.438	•	•	X	•	•	•	•	•	•	•	
S0350004125-250	3.500	4.125	0.250	•	•	•	•	•	•	•	•	X	•	

X: EXISTING TOOLING •: ON REQUEST



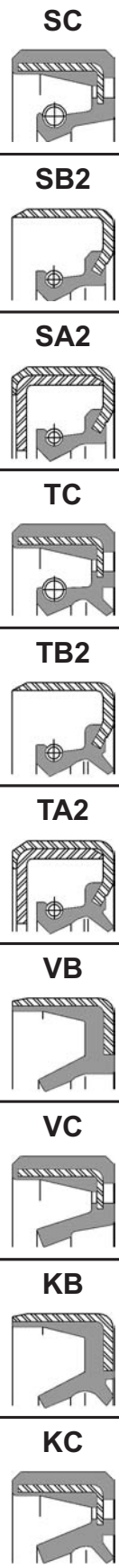











N.B.: MINIMUM LINE ORDER MAY APPLY

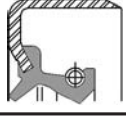
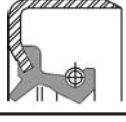

## GLOBAL AVAILABILITY LIST

## RADIAL SHAFT SEALS - NBR/STEEL

INCH SIZE  
SHAFT SEALS

SC 	Ref. Number	Dimensions			DESIGN TYPE									
		d	D	H	SC	SB2	SA2	TC	TB2	TA2	VB	VC	KB	KC
	S0350004376-375	3.500	4.376	0.375	•	•	•	•	•	•	X	•	•	•
	S0350004376-500	3.500	4.376	0.500	•	•	•	•	•	X	•	•	•	•
	S0350004499-250	3.500	4.499	0.250	•	•	•	•	•	•	•	•	•	X
	S0350004501-438	3.500	4.501	0.438	•	•	X	•	•	X	•	•	•	•
	S0350004501-468	3.500	4.501	0.468	•	•	•	•	•	X	•	•	•	•
	S0350004501-500	3.500	4.501	0.500	•	•	X	•	•	•	•	•	•	•
	S0350004625-500	3.500	4.625	0.500	•	•	•	•	•	X	•	•	•	•
	S0350004626-438	3.500	4.626	0.438	•	•	•	•	•	X	•	•	•	•
	S0350004751-500	3.500	4.751	0.500	•	•	•	•	•	X	•	•	•	•
	S0350004875-500	3.500	4.875	0.500	•	•	•	•	•	X	•	•	•	•
	S0350004999-438	3.500	4.999	0.438	•	•	X	•	•	•	•	•	•	•
	S0350004999-468	3.500	4.999	0.468	•	•	•	•	•	X	•	•	•	•
	S0350005126-438	3.500	5.126	0.438	•	•	•	•	•	X	•	•	•	•
	S0350005251-438	3.500	5.251	0.438	•	•	X	•	•	•	•	•	•	•
	S0350005251-468	3.500	5.251	0.468	•	•	•	•	•	X	•	•	•	•
	S0350005500-500	3.500	5.500	0.500	•	•	•	•	•	X	•	•	•	•
	S0350104751-438	3.501	4.751	0.438	•	•	•	•	•	X	•	•	•	•
	S0356204499-468	3.562	4.499	0.468	•	•	•	•	•	X	•	•	•	•
	S0356204625-500	3.562	4.625	0.500	•	•	•	•	•	X	•	•	•	•
	S0356304501-438	3.563	4.501	0.438	•	•	X	•	•	•	•	•	•	•
	S0356304876-438	3.563	4.876	0.438	•	•	X	•	•	•	•	•	•	•
	S0362504240-250	3.625	4.240	0.250	•	•	•	•	•	•	X	•	•	•
	S0362504375-375	3.625	4.375	0.375	•	•	•	•	•	•	X	•	•	•
	S0362504376-375	3.625	4.376	0.375	•	•	•	•	•	•	X	•	•	•
	S0362504499-468	3.625	4.499	0.468	•	•	•	•	•	X	•	•	•	•
	S0362504625-500	3.625	4.625	0.500	•	•	X	•	•	•	•	•	•	•
	S0362504626-438	3.625	4.626	0.438	•	•	•	•	•	X	•	•	•	•
	S0362504751-438	3.625	4.751	0.438	•	•	X	•	•	•	•	•	•	•
	S0362504751-500	3.625	4.751	0.500	•	•	•	•	•	X	•	•	•	•
	S0362504875-500	3.625	4.875	0.500	•	•	•	•	•	X	•	•	•	•
	S0362504876-438	3.625	4.876	0.438	•	•	X	•	•	•	•	•	•	•
	S0362504999-375	3.625	4.999	0.375	•	•	•	•	•	•	X	•	•	•
	S0362504999-500	3.625	4.999	0.500	•	•	•	•	•	X	•	•	•	•
	S0362505251-375	3.625	5.251	0.375	•	•	•	•	•	•	X	•	•	•
	S0362505251-437	3.625	5.251	0.437	•	•	•	•	•	X	•	•	•	•
	S0368704501-500	3.687	4.501	0.500	•	•	•	•	•	X	•	•	•	•
	S0368704750-500	3.687	4.750	0.500	•	•	•	•	•	X	•	•	•	•
	S0368804501-438	3.688	4.501	0.438	•	•	•	•	•	X	•	•	•	•
	S0368804751-438	3.688	4.751	0.438	•	•	•	•	•	X	•	•	•	•
	S0375004376-250	3.750	4.376	0.250	•	•	•	•	•	•	•	•	X	•
	S0375004751-375	3.750	4.751	0.375	•	•	•	•	•	•	X	•	•	•
	S0375004875-500	3.750	4.875	0.500	•	•	•	•	•	X	•	•	•	•
	S0375004876-428	3.750	4.876	0.428	•	•	•	•	•	X	•	•	•	•
	S0375004999-375	3.750	4.999	0.375	•	•	•	•	•	•	X	•	•	•
	S0375004999-438	3.750	4.999	0.438	•	•	•	•	•	X	•	•	•	•
	S0375005251-438	3.750	5.251	0.438	•	•	•	•	•	X	•	•	•	•
	S0375005376-500	3.750	5.376	0.500	•	•	•	•	•	X	•	•	•	•
	S0375006001-500	3.750	6.001	0.500	•	•	X	•	•	•	•	•	•	•

X: EXISTING TOOLING    •: ON REQUEST

N.B.: MINIMUM LINE ORDER MAY APPLY

Tel.: (888) 238-5885  
Fax: (888) 238-1664

**SS**

**41**

[www.sealsonline.com](http://www.sealsonline.com)



INCH SIZE  
SHAFT SEALS

## RADIAL SHAFT SEALS - NBR/STEEL

## GLOBAL AVAILABILITY LIST

Ref. Number	Dimensions			DESIGN TYPE									SC
	d	D	H	SC	SB2	SA2	TC	TB2	TA2	VB	VC	KB	
S0378505126-438	3.785	5.126	0.438	•	•	•	•	•	X	•	•	•	•
S0381204876-500	3.812	4.876	0.500	•	•	•	•	•	X	•	•	•	•
S0381204999-468	3.812	4.999	0.468	•	•	X	•	•	•	•	•	•	•
S0381205251-468	3.812	5.251	0.468	•	•	X	•	•	•	•	•	•	•
S0387504751-375	3.875	4.751	0.375	•	•	•	•	•	X	X	•	•	•
S0387504751-438	3.875	4.751	0.438	•	•	X	X	•	•	•	•	•	•
S0387504875-500	3.875	4.875	0.500	•	•	•	•	•	X	•	•	•	•
S0387504876-500	3.875	4.876	0.500	•	•	•	•	•	X	•	•	•	•
S0387504999-375	3.875	4.999	0.375	•	•	•	•	•	•	X	•	•	•
S0387504999-500	3.875	4.999	0.500	•	•	•	•	•	X	•	•	•	•
S0387505125-500	3.875	5.125	0.500	•	•	•	•	•	X	•	•	•	•
S0387505126-438	3.875	5.126	0.438	•	•	X	•	•	•	•	•	•	•
S0387505251-438	3.875	5.251	0.438	•	•	•	•	•	X	•	•	•	•
S0387505376-438	3.875	5.376	0.438	•	•	X	•	•	•	•	•	•	•
S0387505376-500	3.875	5.376	0.500	•	•	•	•	•	X	•	•	•	•
S0387505501-500	3.875	5.501	0.500	•	•	•	•	•	X	•	•	•	•
S0393704876-500	3.937	4.876	0.500	•	•	•	•	•	X	•	•	•	•
S0393704999-468	3.937	4.999	0.468	•	•	•	•	•	X	•	•	•	•
S0393705251-468	3.937	5.251	0.468	•	•	X	•	•	X	•	•	•	•
S0393705376-500	3.937	5.376	0.500	•	•	•	•	•	X	•	•	•	•
S0393705501-500	3.937	5.501	0.500	•	•	•	•	•	X	•	•	•	•
S0393805000-438	3.938	5.000	0.438	•	•	X	•	•	•	•	•	•	•
S0393805375-438	3.938	5.375	0.438	•	•	X	•	•	•	•	•	•	•
S0393805501-438	3.938	5.501	0.438	•	•	X	•	•	•	•	•	•	•
S0400004876-625	4.000	4.876	0.625	•	•	•	•	•	X	•	•	•	•
S0400004999-250	4.000	4.999	0.250	•	•	X	•	•	•	•	•	•	•
S0400004999-375	4.000	4.999	0.375	•	•	•	X	•	•	•	•	•	•
S0400004999-438	4.000	4.999	0.438	•	•	•	•	•	X	•	•	•	•
S0400005125-500	4.000	5.125	0.500	•	•	•	•	•	X	•	•	•	•
S0400005250-500	4.000	5.250	0.500	•	•	•	•	•	X	•	•	•	•
S0400005251-438	4.000	5.251	0.438	•	•	X	•	•	•	•	•	•	•
S0400005376-500	4.000	5.376	0.500	•	•	•	•	•	X	•	•	•	•
S0400005501-562	4.000	5.501	0.562	•	•	•	•	•	X	•	•	•	•
S0400005625-375	4.000	5.625	0.375	•	•	•	•	•	•	X	•	•	•
S0400005626-375	4.000	5.626	0.375	•	•	•	•	•	X	•	•	•	•
S0400005626-438	4.000	5.626	0.438	•	•	X	•	•	•	•	•	•	•
S0400005751-438	4.000	5.751	0.438	•	•	X	•	•	•	•	•	•	•
S0400005751-562	4.000	5.751	0.562	•	•	•	•	•	X	•	•	•	•
S0400005999-500	4.000	5.999	0.500	•	•	•	•	•	X	•	•	•	•
S0400006250-500	4.000	6.250	0.500	•	•	•	•	•	X	•	•	•	•
S0405005501-548	4.050	5.501	0.548	•	•	•	•	•	X	•	•	•	•
S0412504999-438	4.125	4.999	0.438	•	•	X	•	•	•	•	•	•	•
S0412505126-500	4.125	5.126	0.500	•	•	•	•	•	X	•	•	•	•
S0412505251-468	4.125	5.251	0.468	•	•	•	•	•	X	•	•	•	•
S0412505501-438	4.125	5.501	0.438	•	•	X	•	•	•	•	•	•	•
S0412505501-500	4.125	5.501	0.500	•	•	•	•	•	X	•	•	•	•
S0412505751-562	4.125	5.751	0.562	•	•	•	•	•	X	•	•	•	•
S0418704999-468	4.187	4.999	0.468	•	•	•	•	•	X	•	•	•	•

X: EXISTING TOOLING •: ON REQUEST



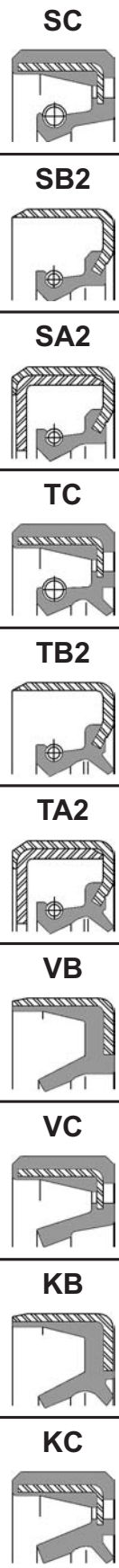











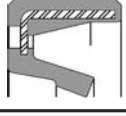

N.B.: MINIMUM LINE ORDER MAY APPLY

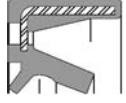

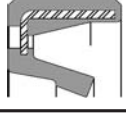
## GLOBAL AVAILABILITY LIST

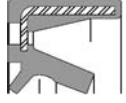
## RADIAL SHAFT SEALS - NBR/STEEL

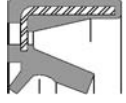
INCH SIZE  
SHAFT SEALS

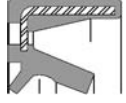
SC 	Ref. Number	Dimensions			DESIGN TYPE									
		d	D	H	SC	SB2	SA2	TC	TB2	TA2	VB	VC	KB	KC
	S0418705251-468	4.187	5.251	0.468	•	•	X	•	•	•	•	•	•	•
	S0418705751-500	4.187	5.751	0.500	•	•	•	•	•	X	•	•	•	•
	S0425004875-313	4.250	4.875	0.313	•	•	•	•	•	•	•	•	X	•
	S0425005250-595	4.250	5.250	0.595	•	•	•	•	X	•	•	•	•	•
	S0425005251-375	4.250	5.251	0.375	•	•	•	•	•	•	X	•	•	•
	S0425005251-438	4.250	5.251	0.438	•	•	X	X	•	•	•	•	•	•
	S0425005376-500	4.250	5.376	0.500	•	•	•	•	•	X	•	•	•	•
	S0425005500-500	4.250	5.500	0.500	•	•	•	•	•	X	•	•	•	•
	S0425005501-438	4.250	5.501	0.438	•	•	X	•	•	•	•	•	•	•
	S0425005626-500	4.250	5.626	0.500	•	•	•	•	•	X	•	•	•	•
	S0425005751-562	4.250	5.751	0.562	•	•	•	•	•	X	•	•	•	•
	S0425005999-500	4.250	5.999	0.500	•	•	•	•	•	X	•	•	•	•
	S0425006001-500	4.250	6.001	0.500	•	•	X	•	•	•	•	•	•	•
	S0425006126-500	4.250	6.126	0.500	•	•	•	•	•	X	•	•	•	•
	S0425006250-562	4.250	6.250	0.562	•	•	•	•	•	X	•	•	•	•
	S0431205376-500	4.312	5.376	0.500	•	•	X	•	•	•	•	•	•	•
	S0431205751-500	4.312	5.751	0.500	•	•	•	•	•	X	•	•	•	•
	S0431206250-500	4.312	6.250	0.500	•	•	•	•	•	X	•	•	•	•
	S0432806693-500	4.328	6.693	0.500	•	•	•	•	•	•	•	X	•	•
	S0433007086-500	4.330	7.086	0.500	•	•	•	•	•	•	•	X	•	•
	S0437505376-500	4.375	5.376	0.500	•	•	•	•	•	X	•	•	•	•
	S0437505500-500	4.375	5.500	0.500	•	•	•	•	•	X	•	•	•	•
	S0437505501-438	4.375	5.501	0.438	•	•	X	•	•	•	•	•	•	•
	S0437505751-562	4.375	5.751	0.562	•	•	•	•	•	X	•	•	•	•
	S0437505999-500	4.375	5.999	0.500	•	•	•	•	•	X	•	•	•	•
	S0437506001-500	4.375	6.001	0.500	•	•	X	•	•	•	•	•	•	•
	S0437506001-500	4.375	6.001	0.500	•	•	•	•	•	X	•	•	•	•
	S0443705751-500	4.437	5.751	0.500	•	•	•	•	•	X	•	•	•	•
	S0443805501-500	4.438	5.501	0.500	•	•	•	•	•	X	•	•	•	•
	S0443806001-500	4.438	6.001	0.500	•	•	X	•	•	•	•	•	•	•
	S0450005001-562	4.500	5.001	0.562	•	•	X	•	•	•	•	•	•	•
	S0450005251-437	4.500	5.251	0.437	•	•	•	•	•	•	•	X	•	•
	S0450005251-438	4.500	5.251	0.438	•	•	X	•	•	•	•	•	•	•
	S0450005376-437	4.500	5.376	0.437	•	•	•	•	•	X	•	•	•	•
	S0450005500-500	4.500	5.500	0.500	•	•	•	•	•	X	•	•	•	•
	S0450005501-375	4.500	5.501	0.375	•	•	•	X	•	•	•	•	•	•
	S0450005501-438	4.500	5.501	0.438	•	•	X	•	•	•	•	•	•	•
	S0450005625-500	4.500	5.625	0.500	•	•	•	•	•	X	•	•	•	•
	S0450005626-438	4.500	5.626	0.438	•	•	X	•	•	•	•	•	•	•
	S0450005750-500	4.500	5.750	0.500	•	•	•	•	•	X	•	•	•	•
	S0450005999-500	4.500	5.999	0.500	•	•	•	•	•	X	•	•	•	•
	S0450006125-562	4.500	6.125	0.562	•	•	•	•	•	X	•	•	•	•
	S0450006126-563	4.500	6.126	0.563	•	•	X	•	•	•	•	•	•	•
	S0450006250-500	4.500	6.250	0.500	•	•	•	•	•	•	•	•	•	•
	S0450006374-500	4.500	6.374	0.500	•	•	•	•	•	X	•	•	•	•
	S0450006750-500	4.500	6.750	0.500	•	•	X	•	•	•	•	•	•	•
	S0456205751-500	4.562	5.751	0.500	•	•	•	•	•	X	•	•	•	•
	S0456305312-250	4.563	5.312	0.250	•	•	•	•	•	•	•	•	X	•
	S0462505625-500	4.625	5.625	0.500	•	•	•	•	•	X	•	•	•	•

X: EXISTING TOOLING    •: ON REQUEST

N.B.: MINIMUM LINE ORDER MAY APPLY

Tel.: (204) 783-9617  
Fax: (204) 783-6091

**SS 43**

[www.sealsonline.com](http://www.sealsonline.com)



**INCH SIZE  
SHAFT SEALS**

## RADIAL SHAFT SEALS - NBR/STEEL

## GLOBAL AVAILABILITY LIST

Ref. Number	Dimensions			DESIGN TYPE									SC
	d	D	H	SC	SB2	SA2	TC	TB2	TA2	VB	VC	KB	
S0462505751-562	4.625	5.751	0.562	*	*	*	*	*	X	*	*	*	*
S0462505999-500	4.625	5.999	0.500	*	*	*	*	*	X	*	*	*	*
S0462506001-500	4.625	6.001	0.500	*	*	X	*	*	*	*	*	*	*
S0468705751-500	4.687	5.751	0.500	*	*	*	*	*	X	*	*	*	*
S0475005625-437	4.750	5.625	0.437	*	*	X	*	*	*	*	*	*	*
S0475005751-500	4.750	5.751	0.500	*	*	*	*	*	X	*	*	*	*
S0475005876-500	4.750	5.876	0.500	*	*	*	*	*	X	*	*	*	*
S0475005999-625	4.750	5.999	0.625	*	*	*	*	*	X	*	*	*	*
S0475006000-750	4.750	6.000	0.750	*	*	*	*	*	X	*	*	*	*
S0475006001-500	4.750	6.001	0.500	*	*	*	*	*	X	*	*	*	*
S0475006125-500	4.750	6.125	0.500	*	*	*	*	*	X	*	*	*	*
S0475006250-562	4.750	6.250	0.562	*	*	*	*	*	X	*	*	*	*
S0487505999-500	4.875	5.999	0.500	*	*	*	*	*	X	*	*	*	*
S0487506001-500	4.875	6.001	0.500	*	*	X	*	*	*	*	*	*	*
S0487506125-500	4.875	6.125	0.500	*	*	*	*	*	X	*	*	*	*
S0487506250-500	4.875	6.250	0.500	*	*	*	*	*	X	*	*	*	*
S0487506749-500	4.875	6.749	0.500	*	*	X	*	*	*	*	*	*	*
S0493705999-500	4.937	5.999	0.500	*	*	*	*	*	X	*	*	*	*
S0493706250-500	4.937	6.250	0.500	*	*	*	*	*	X	*	*	*	*
S0500005625-313	5.000	5.625	0.313	*	*	*	*	*	*	*	*	X	*
S0500006001-500	5.000	6.001	0.500	*	*	*	*	*	X	*	*	*	*
S0500006250-500	5.000	6.250	0.500	*	*	X	*	*	*	*	*	*	*
S0500006250-563	5.000	6.250	0.563	*	*	*	*	*	X	*	*	*	*
S0500006375-375	5.000	6.375	0.375	*	*	*	*	*	X	*	*	*	*
S0500006375-500	5.000	6.375	0.500	*	*	*	*	*	X	*	*	*	*
S0500006499-500	5.000	6.499	0.500	*	*	*	*	*	X	*	*	*	*
S0500006749-500	5.000	6.749	0.500	*	*	*	*	*	X	*	*	*	*
S0500007000-500	5.000	7.000	0.500	*	*	*	*	*	X	*	*	*	*
S0500007500-500	5.000	7.500	0.500	*	*	*	*	*	X	*	*	*	*
S0506206202-625	5.062	6.202	0.625	*	*	X	*	*	*	*	*	*	*
S0512506125-500	5.125	6.125	0.500	*	*	*	*	*	X	*	*	*	*
S0512506250-500	5.125	6.250	0.500	*	*	*	*	*	X	*	*	*	*
S0512506374-500	5.125	6.374	0.500	*	*	*	*	*	X	*	*	*	*
S0512506499-500	5.125	6.499	0.500	*	*	*	*	*	X	*	*	*	*
S0525006250-500	5.250	6.250	0.500	*	*	*	*	*	X	*	*	*	*
S0525006375-500	5.250	6.375	0.500	*	*	*	*	*	X	*	*	*	*
S0525006500-562	5.250	6.500	0.562	*	*	*	*	*	X	*	*	*	*
S0525006750-500	5.250	6.750	0.500	*	*	*	*	*	X	*	*	*	*
S0531206500-500	5.312	6.500	0.500	*	*	*	*	*	X	*	*	*	*
S0537506374-500	5.375	6.374	0.500	*	*	*	*	*	X	*	*	*	*
S0537506499-562	5.375	6.499	0.562	*	*	X	*	*	*	*	*	*	*
S0537506499-625	5.375	6.499	0.625	*	*	*	*	*	X	*	*	*	*
S0537506625-500	5.375	6.625	0.500	*	*	*	*	*	X	*	*	*	*
S0537506625-625	5.375	6.625	0.625	*	*	X	*	*	X	*	*	*	*
S0537506749-500	5.375	6.749	0.500	*	*	*	*	*	X	*	*	*	*
S0550006250-500	5.500	6.250	0.500	*	*	*	*	X	*	X	*	*	*
S0550006310-1188	5.500	6.310	1.188	*	*	*	*	*	*	X	*	*	*
S0550006500-500	5.500	6.500	0.500	*	*	X	*	X	*	*	*	*	*

X: EXISTING TOOLING \* : ON REQUEST



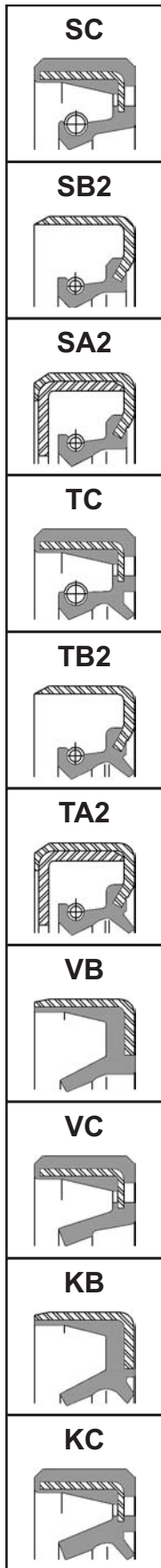





N.B.: MINIMUM LINE ORDER MAY APPLY

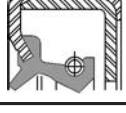

## GLOBAL AVAILABILITY LIST

## RADIAL SHAFT SEALS - NBR/STEEL

INCH SIZE  
SHAFT SEALS

SC 	Ref. Number	Dimensions			DESIGN TYPE									
		d	D	H	SC	SB2	SA2	TC	TB2	TA2	VB	VC	KB	KC
	S0550006500-562	5.500	6.500	0.562	•	•	•	•	•	X	•	•	•	•
	S0550006625-562	5.500	6.625	0.562	•	•	•	•	•	X	•	•	•	•
	S0550006750-500	5.500	6.750	0.500	•	•	•	•	•	X	•	•	•	•
	S0550006750-575	5.500	6.750	0.575	•	•	•	•	•	X	•	•	•	•
	S0550006875-562	5.500	6.875	0.562	•	•	•	•	•	X	•	•	•	•
	S0550007125-625	5.500	7.125	0.625	•	•	•	•	•	X	•	•	•	•
	S0550007501-563	5.500	7.501	0.563	•	•	X	•	•	•	•	•	•	•
	S0550008268-500	5.500	8.268	0.500	•	•	•	•	•	•	•	X	•	•
	S0562506624-500	5.625	6.624	0.500	•	•	•	•	•	X	•	•	•	•
	S0562506625-500	5.625	6.625	0.500	•	•	X	•	•	•	•	•	•	•
	S0562506874-500	5.625	6.874	0.500	•	•	•	•	•	X	•	•	•	•
	S0562507000-500	5.625	7.000	0.500	•	•	•	•	•	X	•	•	•	•
	S0562507125-500	5.625	7.125	0.500	•	•	•	•	•	X	•	•	•	•
	S0575006624-625	5.750	6.624	0.625	•	•	•	•	•	X	•	•	•	•
	S0575006750-500	5.750	6.750	0.500	•	•	X	•	•	•	•	•	•	•
	S0575006750-575	5.750	6.750	0.575	•	•	•	•	•	X	•	•	•	•
	S0575007000-625	5.750	7.000	0.625	•	•	X	•	•	•	•	•	•	•
	S0575007001-562	5.750	7.001	0.562	•	•	•	•	•	X	•	•	•	•
	S0575007500-562	5.750	7.500	0.562	•	•	•	•	•	X	•	•	•	•
	S0575007874-750	5.750	7.874	0.750	•	•	•	•	•	X	•	•	•	•
	S0587506749-625	5.875	6.749	0.625	•	•	•	•	X	•	•	•	•	•
	S0587507125-500	5.875	7.125	0.500	•	•	•	•	•	X	•	•	•	•
	S0587507500-562	5.875	7.500	0.562	•	•	X	•	•	•	•	•	•	•
	S0593707502-562	5.937	7.502	0.562	•	•	•	•	•	X	•	•	•	•
	S0600007000-500	6.000	7.000	0.500	•	•	•	•	•	X	•	•	•	•
	S0600007125-562	6.000	7.125	0.562	•	•	•	•	•	X	•	•	•	•
	S0600007500-250	6.000	7.500	0.250	•	•	X	•	•	•	•	•	•	•
	S0600007500-500	6.000	7.500	0.500	•	•	•	•	•	X	•	•	•	•
	S0612507125-625	6.125	7.125	0.625	•	•	X	•	•	•	•	•	•	•
	S0612507500-562	6.125	7.500	0.562	•	•	•	•	•	X	•	•	•	•
	S0612507627-625	6.125	7.627	0.625	•	•	X	•	•	•	•	•	•	•
	S0618707500-562	6.187	7.500	0.562	•	•	X	•	•	•	•	•	•	•
	S0625007500-562	6.250	7.500	0.562	•	•	X	•	•	•	•	•	•	•
	S0625007750-500	6.250	7.750	0.500	•	•	•	•	•	X	•	•	•	•
	S0625007875-750	6.250	7.875	0.750	•	•	•	•	•	X	•	•	•	•
	S0637507875-500	6.375	7.875	0.500	•	•	•	•	•	X	•	•	•	•
	S0637507875-563	6.375	7.875	0.563	•	•	•	•	•	X	•	•	•	•
	S0650007500-562	6.500	7.500	0.562	•	•	•	•	•	X	•	•	•	•
	S0650008000-625	6.500	8.000	0.625	•	•	•	•	•	X	•	•	•	•
	S0662507750-500	6.625	7.750	0.500	•	•	X	•	•	•	•	•	•	•
	S0662508125-625	6.625	8.125	0.625	•	•	•	•	•	X	•	•	•	•
	S0675008000-625	6.750	8.000	0.625	•	•	•	•	•	X	•	•	•	•
	S0675008007-625	6.750	8.007	0.625	•	•	•	•	•	X	•	•	•	•
	S0675008250-562	6.750	8.250	0.562	•	•	•	•	•	X	•	•	•	•
	S0687507875-625	6.875	7.875	0.625	•	•	X	•	•	•	•	•	•	•
	S0687508375-625	6.875	8.375	0.625	•	•	•	•	•	•	•	•	•	•
	S0700008000-625	7.000	8.000	0.625	•	•	•	•	•	X	•	•	•	•
	S0700008250-625	7.000	8.250	0.625	•	•	•	•	•	X	•	•	•	•

•: EXISTING TOOLING    •: ON REQUEST

N.B.: MINIMUM LINE ORDER MAY APPLY

Tel.: (780) 414-1871  
Fax: (780) 487-5419

**SS 45**

[www.sealsonline.com](http://www.sealsonline.com)



## RADIAL SHAFT SEALS - NBR/STEEL

## GLOBAL AVAILABILITY LIST

Ref. Number	Dimensions			DESIGN TYPE									SC
	d	D	H	SC	SB2	SA2	TC	TB2	TA2	VB	VC	KB	
S070008500-625	7.000	8.500	0.625	•	•	•	•	•	X	•	•	•	•
S070009313-625	7.000	9.313	0.625	•	•	•	•	•	X	•	•	•	•
S0712508625-562	7.125	8.625	0.562	•	•	•	•	•	X	•	•	•	•
S0725008250-625	7.250	8.250	0.625	•	•	•	•	•	X	•	•	•	•
S0725008750-750	7.250	8.750	0.750	•	•	•	•	•	X	•	•	•	•
S0737508875-750	7.375	8.875	0.750	•	•	X	•	•	•	•	•	•	•
S0750008500-625	7.500	8.500	0.625	•	•	•	•	•	X	•	•	•	•
S0750009000-750	7.500	9.000	0.750	•	•	•	•	•	X	•	•	•	•
S0762508625-562	7.625	8.625	0.562	•	•	•	•	•	X	•	•	•	•
S0762509125-625	7.625	9.125	0.625	•	•	•	•	•	X	•	•	•	•
S0775008750-625	7.750	8.750	0.625	•	•	X	•	•	•	•	•	•	•
S0775009250-625	7.750	9.250	0.625	•	•	X	•	•	•	•	•	•	•
S0775010000-750	7.750	10.000	0.750	•	•	•	•	•	X	•	•	•	•
S0787509375-750	7.875	9.375	0.750	•	•	X	•	•	•	•	•	•	•
S0800009250-625	8.000	9.250	0.625	•	•	•	•	•	X	•	•	•	•
S0800009500-625	8.000	9.500	0.625	•	•	•	•	•	X	•	•	•	•
S0800010000-625	8.000	10.000	0.625	•	•	•	•	•	X	•	•	•	•
S0812510125-750	8.125	10.125	0.750	•	•	X	•	•	•	•	•	•	•
S0825010250-750	8.250	10.250	0.750	•	•	•	•	•	X	•	•	•	•
S0825010625-750	8.250	10.625	0.750	•	•	•	•	•	X	•	•	•	•
S0837510375-625	8.375	10.375	0.625	•	•	•	•	•	X	•	•	•	•
S0850010000-625	8.500	10.000	0.625	•	•	•	•	•	X	•	•	•	•
S0850010500-625	8.500	10.500	0.625	•	•	•	•	•	X	•	•	•	•
S0850010625-750	8.500	10.625	0.750	•	•	•	•	•	X	•	•	•	•
S0862510625-750	8.625	10.625	0.750	•	•	•	•	•	X	•	•	•	•
S0875010750-750	8.750	10.750	0.750	•	•	•	•	•	X	•	•	•	•
S0887510122-750	8.875	10.122	0.750	•	•	•	•	•	X	•	•	•	•
S0900010000-750	9.000	10.000	0.750	•	•	X	•	•	•	•	•	•	•
S0900010375-625	9.000	10.375	0.625	•	•	X	•	•	•	•	•	•	•
S0900010500-750	9.000	10.500	0.750	•	•	X	•	•	•	•	•	•	•
S0900011000-750	9.000	11.000	0.750	•	•	•	•	•	X	•	•	•	•
S0925011250-750	9.250	11.250	0.750	•	•	•	•	•	X	•	•	•	•
S0950011500-625	9.500	11.500	0.625	•	•	•	•	•	X	•	•	•	•
S0962512750-1250	9.625	12.750	1.250	•	•	•	•	•	X	•	•	•	•
S0975011000-625	9.750	11.000	0.625	•	•	X	•	•	•	•	•	•	•
S1000011000-625	10.000	11.000	0.625	•	•	•	•	•	X	•	•	•	•
S1000012000-625	10.000	12.000	0.625	•	•	•	•	•	X	•	•	•	•
S1025012250-750	10.250	12.250	0.750	•	•	•	•	•	X	•	•	•	•
S1050012000-688	10.500	12.000	0.688	•	•	X	•	•	•	•	•	•	•
S1050012500-1000	10.500	12.500	1.000	•	•	•	•	•	X	•	•	•	•
S1075013374-1250	10.750	13.374	1.250	•	•	•	•	•	X	•	•	•	•
S1100012250-625	11.000	12.250	0.625	•	•	•	•	•	•	•	X	•	•
S1100012500-625	11.000	12.500	0.625	•	•	•	•	•	X	•	•	•	•
S1100013000-750	11.000	13.000	0.750	•	•	•	•	•	X	•	•	•	•
S1150013000-750	11.500	13.000	0.750	•	•	•	•	•	X	•	•	•	•
S1150013500-750	11.500	13.500	0.750	•	•	•	•	•	X	•	•	•	•
S1200014000-750	12.000	14.000	0.750	•	•	•	•	•	X	•	•	•	•

X: EXISTING TOOLING •: ON REQUEST

N.B.: MINIMUM LINE ORDER MAY APPLY

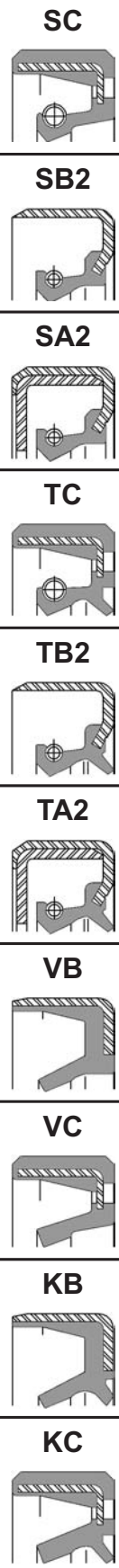

PRESSURE SEALS - JM CLIPPER

JM Clipper Corporation  
ISO-9001  
CERTIFIED

"Manufacturers of High Quality Shaft Seals for Over 50 Years"

# Shaft Seals for Pressure Service

- Pressures to 300 psi
- Broad Service Parameters
- Economical



INCH SIZE  
SHAFT SEALS



Tel.: (604) 278-6808  
Fax: (604) 278-6180

**SS 47**

[www.sealsonline.com](http://www.sealsonline.com)



## PRESSURE SEALS - JM CLIPPER

JM Clipper Corporation

# SHAFT SEALS FOR PRESSURE SERVICE

## *Don't let the pressure get you down!*

Excessive wear and heat build-up at the lip of shaft-seals is frequently caused by internal pressure. Whether this pressure is intentional or not, JM CLIPPER may have a solution that can allow you to avoid expensive equipment design or fixes — shaft-seals offering the special pressure performance you need, at the lowest cost!



HP SEAL



MP SEAL

If it's high pressure you're dealing with ( to 300 psi), you can look to our HP SEAL which has been solving problems for years. It's built tough with a fluoroelastomer sealing element, a strong metal case and a large, pressure activated, PTFE anti-friction element. It has an impressive pressure times velocity factor of 300,000, and can be used in a broad range of equipment, in rotary or reciprocating motion, at a cost less than many alternatives.

On the other hand, if pressure is in a more moderate range (to 100 psi), our MP SEAL gives you an even less costly solution. It has a pressure times velocity factor of 100,000, so it can operate in many different rotary applications. A rugged seal, it incorporates an elastomer covered metal shell for better O.D. sealing in the bore. The standard MP SEAL is offered in a special fluoroelastomer compound. Other materials are available at no premium. Years of experience with the MP SEAL have led to technical improvements that make today's MP SEAL a great design alternative.

INCH SIZE  
SHAFT SEALS



## PRESSURE SEALS - JM CLIPPER

"Manufacturers of High Quality Shaft Seals for Over 50 Years"

INCH SIZE  
SHAFT SEALS

SPECIFICATION DATA		HP	MP
<b>Recommended Tolerances, Finishes, Design, and Installation Specifics</b>			
Minimum Bore & Shaft Entrance Chamfers		30° x 1/32"	30° x 1/32"
Shaft Hardness		30 Rockwell C. minimum 50 Rockwell C. maximum	30 Rockwell C. minimum 50 Rockwell C. maximum
Shaft Tolerance		± .001"	± .002"
Shaft Finish		10-20 RMS	10-20 RMS
Shaft Speeds <i>PV = Pressure (psi) x velocity (FPM)</i>		to 4000 FPM (max.) limited to 300,000 'PV'	to 4000 FPM (max.) limited to 100,000 'PV'
Bore Tolerance	Up to 3"	+ .001"	+ .0015"
	3.001 and above	± .002"	± .002"
Bore Finish		15-60 RMS	15-60 RMS
Cavity Depth		± .015" (must be a minimum 1/16" deeper than seal width)	± .015" (must be a minimum 1/16" deeper than seal width)
Shaft-to-Bore Misalignment	T.I.R. maximum	.003"	.005"
Shaft Runout	T.I.R. maximum	.003"	.005"
Fluid Service Temperature		-40°F to +400°F	-40°F to +400°F
Fluid Pressure		0 to 300 psi (limited to 300,000 'PV')	0 to 100 psi (limited to 100,000 'PV')
		Use Snap Ring or Backup Plate for Pressures over 50 psi.	Use Snap Ring or Backup Plate for Pressures over 20 psi.

### SIZES

JM CLIPPER HP Seals can be furnished for shaft diameters 1/2" through 8" in equal flange and widths 1/4" through 1 1/8". Maximum O.D. is 9.250". MP seals can be furnished from a shaft diameter of 1/2" to a maximum O.D. of 14.500". Smaller or larger sizes by special request.

### INSTALLATION

Both the HP and the MP seal can be installed in the conventional oil seal cavity with standard metal shell installation tools. Both can also be readily installed reversed in detached cavity holders which are separately mounted to the equipment body. Special bore dimensions are required. Contact your JM CLIPPER representative for more information.

The physical (or chemical) properties of JM CLIPPER Seals represent typical, average values obtained in accordance with accepted test methods and are subject to normal manufacturing variations. They are supplied as a technical service and subject to change without notice. Check with our factory to assure current information.

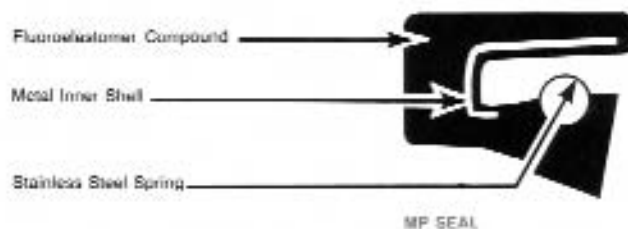
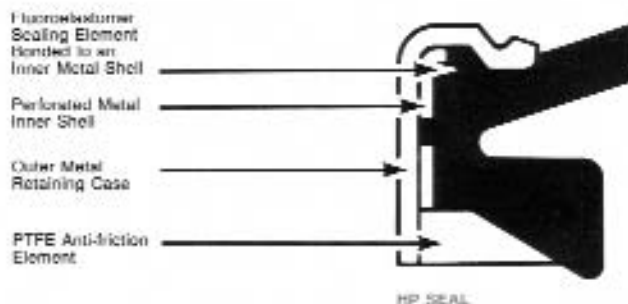

**INCH SIZE  
SHAFT SEALS**

## PRESSURE SEALS - JM CLIPPER

Ref. Number	Dimensions			Design Type	Ref. Number	Dimensions			Design Type	Ref. Number	Dimensions			Design Type
	d	D	H			d	D	H			d	D	H	
JM0025-15596	0.250	0.750	0.250	HP	JM0175-15410	1.750	3.000	0.625	HP	JM0374-18761	3.740	4.449	0.394	HP
JM0037-15257	0.375	0.750	0.250	HP	JM0181-16382	1.813	2.500	0.344	HP	JM0375-16624	3.750	5.000	0.625	HP
JM0050-17801	0.500	0.875	0.250	HP	JM0184-16338	1.844	2.875	0.469	HP	JM0384-17971	3.844	4.594	0.375	HP
JM0050-15059	0.500	1.000	0.250	HP	JM0187-16092	1.875	2.625	0.375	HP	JM0387-17209	3.875	4.625	0.375	HP
JM0056-15805	0.563	1.125	0.281	HP	JM0187-16396	1.875	2.750	0.375	HP	JM0400-15092	4.000	5.250	0.625	HP
JM0062-18020	0.625	1.125	0.250	HP	JM0193-15978	1.938	2.471	0.267	HP	JM0406-17968	4.250	5.000	0.375	HP
JM0062-15598	0.625	1.250	0.313	HP	JM0193-16496	1.938	2.750	0.375	HP	JM0413-18163	4.138	5.500	0.656	HP
JM0068-15384	0.688	1.375	0.344	HP	JM0200-15216	2.000	2.688	0.344	HP	JM0425-15373	4.250	5.000	0.375	HP
JM0075-15487	0.750	1.250	0.250	HP	JM0200-15800	2.000	2.875	0.438	HP	JM0450-15787	4.500	5.750	0.625	HP
JM0075-17698	0.750	1.375	0.406	HP	JM0200-15218	2.000	3.000	0.500	HP	JM0462-17385	4.625	5.625	0.500	HP
JM0078-18716	0.781	1.750	0.313	HP	JM0212-16443	2.125	2.875	0.375	HP	JM0475-17969	4.750	5.500	0.375	HP
JM0087-15378	0.875	1.375	0.250	HP	JM0212-18908	2.125	2.996	0.495	HP	JM0487-17462	4.875	5.250	0.182	HP
JM0087-18855	0.875	1.500	0.313	HP	JM0218-17182	2.188	2.938	0.375	HP	JM0500-15639	5.000	6.250	0.625	HP
JM0087-17697	0.875	1.500	0.391	HP	JM0218-16697	2.188	3.000	0.500	HP	JM0600-19081	6.000	7.250	0.500	HP
JM0097-17998	0.970	1.500	0.250	HP	JM0225-16399	2.250	2.875	0.313	HP	JM0625-16344	6.250	7.500	0.625	HP
JM0098-17161	0.984	1.750	0.313	HP	JM0225-15455	2.250	3.000	0.375	HP	JM0800-17772	8.000	9.250	0.625	HP
JM0098-19011	0.984	1.750	0.313	HP	JM0228-18801	2.285	3.150	0.394	HP					
JM0100-16171	1.000	1.500	0.250	HP	JM0231-16498	2.313	3.000	0.375	HP					
JM0106-18863	1.063	1.563	0.313	HP	JM0237-16807	2.375	3.125	0.375	HP					
JM0112-15385	1.125	1.625	0.250	HP	JM0237-19445	2.375	3.250	0.375	HP					
JM0112-19228	1.125	1.875	0.344	HP	JM0237-17699	2.375	3.355	0.469	HP					
JM0112-19261	1.125	1.875	0.375	HP	JM0244-18764	2.441	3.346	0.394	HP					
JM0112-18854	1.125	2.066	0.432	HP	JM0250-16699	2.500	3.188	0.375	HP					
JM0115-19420	1.156	1.693	0.313	HP	JM0250-15411	2.500	4.000	0.750	HP					
JM0118-19431	1.181	1.771	0.276	HP	JM0256-17183	2.563	3.313	0.375	HP					
JM0118-15483	1.188	1.875	0.344	HP	JM0262-15390	2.625	3.375	0.375	HP					
JM0118-16504	1.188	1.875	0.344	HP	JM0268-16334	2.688	3.372	0.375	HP					
JM0125-19320	1.250	1.625	0.250	HP	JM0275-16397	2.750	3.375	0.313	HP					
JM0125-15786	1.250	2.000	0.375	HP	JM0275-15672	2.750	3.625	0.438	HP					
JM0125-19432	1.250	2.047	0.276	HP	JM0287-16694	2.875	3.500	0.375	HP					
JM0131-18853	1.313	2.375	0.313	HP	JM0293-16381	2.938	3.625	0.344	HP					
JM0137-15883	1.375	2.000	0.313	HP	JM0300-16698	3.000	3.750	0.375	HP					
JM0137-17897	1.375	2.125	0.335	HP	JM0300-17700	3.000	4.000	0.438	HP					
JM0137-15058	1.375	2.250	0.375	HP	JM0300-15185	3.000	4.125	0.563	HP					
JM0137-16520	1.375	2.375	0.500	HP	JM0309-18112	3.094	3.844	0.375	HP					
JM0143-15405	1.438	2.000	0.281	HP	JM0312-17181	3.125	3.875	0.375	HP					
JM0143-17177	1.438	2.000	0.281	HP	JM0312-15925	3.125	4.375	0.625	HP					
JM0143-16759	1.438	2.375	0.406	HP	JM0318-18167	3.188	4.250	0.531	HP					
JM0150-15409	1.500	2.250	0.375	HP	JM0322-18762	3.228	3.938	0.354	HP					
JM0156-16400	1.563	2.250	0.344	HP	JM0325-17970	3.250	4.000	0.375	HP					
JM0156-17973	1.563	2.500	0.313	HP	JM0325-17389	3.250	4.750	0.625	HP					
JM0156-18844	1.563	2.625	0.438	HP	JM0334-15544	3.346	4.331	0.500	HP					
JM0162-16794	1.625	2.250	0.313	HP	JM0337-15699	3.375	4.125	0.375	HP					
JM0162-15969	1.625	2.375	0.375	HP	JM0337-16451	3.375	4.375	0.500	HP					
JM0168-15714	1.688	2.188	0.250	HP	JM0343-17967	3.438	4.188	0.375	HP					
JM0175-15898	1.750	2.500	0.375	HP	JM0350-16312	3.500	4.500	0.500	HP					
JM0175-17339	1.750	2.625	0.438	HP	JM0350-15470	3.500	4.625	0.563	HP					
JM0175-16812	1.750	2.750	0.375	HP	JM0362-19345	3.625	4.625	0.500	HP					

N.B.: MINIMUM LINE ORDER MAY APPLY

## PRESSURE SEALS - NOK

INCH SIZE  
SHAFT SEALS

### TB4

NOK Metal OD, Two stepped Main Lip Oil Seal with Auxiliary Dust Lip

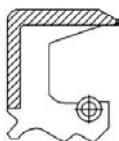

Severe reciprocating shaft applications can be effectively sealed by the "T4" design. Pressure up to 100 psi (7kg/cm<sup>2</sup>) can be sealed, such as in shock absorbers.

### TC4

NOK Rubber OD, Double Lip, Two Stepped Main Lip Oil Seal



Severe reciprocating shaft applications can be effectively sealed by the "T4" design. Pressure up to 100 psi (7kg/cm<sup>2</sup>) can be sealed, such as in shock absorbers.

### TCN

NOK Rubber OD, Double Lip, Pressure Seal



Type "TCN" is designed for high pressure applications where continuous pressure may reach 150 psi (10.6kg/cm<sup>2</sup>). Maximum pressure limit is dependent on shaft speed.

### TCV

NOK Rubber OD, Double Lip, Pressure Seal

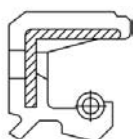









Type "TCV" is designed for high pressure applications where continuous pressure may reach 50 psi (10.6kg/cm<sup>2</sup>). Maximum pressure limit is dependent on shaft speed.

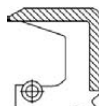
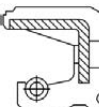

**INCH SIZE  
SHAFT SEALS**

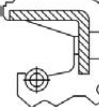
## PRESSURE SEALS - NOK

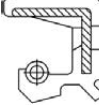
## NOK AVAILABILITY LIST





NOK Ref.	Dimensions			Design Type	NOK Ref.	Dimensions			Design Type	TB4  100 PSI
	d	D	H			d	D	H		
AR7099-E0	0.310	0.640	0.270	TC4	AR8327-P0	0.550	1.330	0.470	TC4	
AR7099-F0	0.310	0.640	0.270	TC4	AR8327-P0	0.551	1.331	0.472	TC4	
BR4312-E0	0.310	0.710	0.270	TC4	UR0374-E1	0.561	0.998	0.252	TC4	
AR0146-E0	0.310	0.760	0.390	TC4	BP4357-E0	0.620	1.100	0.270	TCV	
AR0150-E0	0.310	0.760	0.390	TC4	BP0048-E0	0.620	1.250	0.270	TCN	TC4  100 PSI
AR0155-F0	0.310	0.840	0.390	TC4	BP4357-E0	0.622	1.102	0.276	TCV	
AR0155-F0	0.310	0.840	0.390	TC4	BPP060-A0	0.625	1.124	0.252	TCV	
AP8363-E0	0.313	1.000	0.252	TCV	AP0647-E0	0.625	1.124	0.374	TCV	
AR7099-E0	0.315	0.650	0.276	TC4	BP0048-E0	0.625	1.260	0.276	TCN	TCN  150 PSI
AR7099-F0	0.315	0.650	0.276	TC4	BP3754-E0	0.660	1.170	0.270	TCV	
BR4312-E0	0.315	0.717	0.276	TC4	BP3754-E0	0.669	1.177	0.276	TCV	
AR0146-E0	0.315	0.768	0.394	TC4	BE4506-E0	0.680	1.080	0.270	TC4	
AR0150-E0	0.315	0.768	0.394	TC4	UP0192-E0	0.680	1.120	0.270	TCN/V	TCV  50 PSI
AR0155-F0	0.315	0.846	0.394	TC4	AP0787-E0	0.680	1.180	0.310	TCV	
BR5050-E0	0.340	0.640	0.270	TC4	AP0787-F0	0.680	1.180	0.310	TCV	
BR5050-E0	0.343	0.650	0.276	TC4	UR0470-E0	0.687	1.060	0.252	TC4	
AP8596-E0	0.430	1.020	0.230	TCV	UP0192-E0	0.687	1.124	0.280	TCN/V	TB4  100 PSI
AR7468-P0	0.430	1.330	0.470	TC4	BPP655-A0	0.687	1.125	0.248	TCV	
AR7468-P0	0.433	1.331	0.472	TC4	AP0787-F0	0.687	1.187	0.315	TCV	
AP8211-E0	0.436	0.871	0.252	TCV	AP0787-E0	0.687	1.187	0.315	TCV	
BPP086-A0	0.436	0.871	0.252	TCV	APP820-A0	0.687	1.250	0.252	TCV	TC4  100 PSI
AP8596-E0	0.436	1.024	0.236	TCV	BE4506-E0	0.689	1.083	0.276	TC4	
UP0871-E0	0.436	1.188	0.236	TCV	BP4721-E0	0.740	1.240	0.310	TCV	
UP0402-E0	0.437	0.875	0.252	TCV	BR0074-E0	0.740	1.370	0.310	TB4	
BRR191-A0	0.488	1.000	0.311	TC4	UP0184-E0	0.745	1.497	0.252	TCV	TC4  150 PSI
BP2209-E0	0.490	0.880	0.270	TCV	BR0074-E0	0.747	1.375	0.315	TB4	
AP0406-G0	0.490	1.180	0.350	TCV/V	BP4721-E0	0.748	1.248	0.315	TCV	
AP0406-F0	0.490	1.180	0.350	TCV	BPP726-A0	0.750	1.063	0.197	TCV	
AP0406-F0	0.490	1.181	0.354	TCV	AP8921-E0	0.750	1.188	0.252	TCV	TCV  50 PSI
AP0406-G0	0.490	1.181	0.354	TCV/V	BPP422-A0	0.750	1.188	0.252	TCV	
BR2138-E0	0.490	1.570	0.470	TC4	AR8557-E0	0.750	1.376	0.374	TB4	
BP2209-E0	0.492	0.886	0.276	TCV	AR8557-E1	0.750	1.376	0.374	TB4	
BR2138-E0	0.492	1.575	0.472	TC4	BPP085-A0	0.750	1.499	0.311	TCN	TCN  100 PSI
BP1362-E0	0.500	0.875	0.250	TCV	AP7744-F0	0.750	1.499	0.311	TCN	
BP1362-F0	0.500	0.875	0.250	TCV	UP0399-E0	0.781	1.752	0.311	TCN	
AP8940-E0	0.500	0.879	0.250	TCV	BR1608-E0	0.800	1.250	0.290	TC4	
UP0669-E0	0.500	0.879	0.250	TCV	BR1608-E0	0.807	1.260	0.295	TC4	TCN  150 PSI
AP0418-E0	0.500	1.000	0.311	TCV/V	UP0285-E0	0.812	1.375	0.311	TCV	
AP0452-E0	0.500	1.000	0.311	TCV/V	AP1164-E0	0.870	1.490	0.310	TCV/V	
AP0457-E0	0.500	1.124	0.311	TCV	AP6826-E0	0.870	1.490	0.310	TCV	
BP4945-E0	0.520	1.060	0.310	TCV/V	AP1164-E0	0.871	1.499	0.311	TCV/V	TCV  50 PSI
AP8356-E0	0.530	1.060	0.270	TCV	AP6826-E0	0.872	1.497	0.315	TCV	
AP6825-E0	0.530	1.060	0.310	TCV	AP1182-E0	0.875	1.375	0.311	TCV	
AP6825-E1	0.530	1.060	0.310	TCV	UP0007-E0	0.875	1.497	0.252	TCV	
BP4945-E0	0.530	1.062	0.315	TCV/V	AP1190-E0	0.875	1.500	0.311	TCV	TCN  100 PSI
AP8356-E0	0.531	1.063	0.276	TCV	AP6808-E0	0.880	1.490	0.310	TCV	
AP6825-E0	0.531	1.063	0.315	TCV	BR2740-E0	0.880	1.570	0.390	TC4	
AP6825-E1	0.531	1.063	0.315	TCV	BR2741-E0	0.880	1.570	0.390	TC4	

N.B.: MINIMUM LINE ORDER MAY APPLY

## NOK AVAILABILITY LIST

## PRESSURE SEALS - NOK

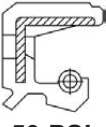
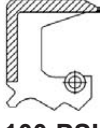
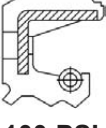
**INCH SIZE  
SHAFT SEALS**

<b>TB4</b>  <b>100 PSI</b>	NOK Ref.	Dimensions			Design Type	NOK Ref.	Dimensions			Design Type
		d	D	H			d	D	H	
<b>TC4</b>  <b>100 PSI</b>	AP6808-E0	0.882	1.496	0.315	TCV	BP2411-E0	1.120	1.750	0.270	TCV
	BR2741-E0	0.882	1.575	0.394	TC4	AP7719-F0	1.120	1.990	0.250	TCV/V
	BR2740-E0	0.882	1.575	0.394	TC4	BP2411-E0	1.125	1.756	0.276	TCV
	BP1142-E0	0.960	1.750	0.430	TCN	UP0259-E0	1.125	1.828	0.311	TCV
	AP8725-E0	0.960	2.120	0.270	TCV	AP7719 E0	1.125	1.998	0.252	TCV
	AP8725-E1	0.960	2.120	0.270	TCV	AP7719-F0	1.125	1.998	0.252	TCV/V
	AP8240-E0	0.969	1.686	0.311	TCV	AP8029-E0	1.150	1.500	0.180	TCV/V
	AP8240-E1	0.969	1.686	0.311	TCV	AP1636-G0	1.150	1.680	0.310	TCV/V
<b>TCN</b>  <b>150 PSI</b>	AP8240-F0	0.969	1.686	0.311	TCV	AP1636-H0	1.150	1.680	0.310	TCV
	UP0779-E0	0.969	1.752	0.311	TCN	AP8029-E0	1.156	1.500	0.189	TCV/V
	AP8214-E0	0.969	1.752	0.311	TCV	BPP173-A0	1.156	1.686	0.311	TCV
	AP8214-F0	0.969	1.752	0.311	TCV	AP1636-F0	1.156	1.686	0.311	TCV
	BPP079-A0	0.969	1.752	0.311	TCV	AP1636-G0	1.156	1.686	0.311	TCV/V
	BP1142-E0	0.969	1.756	0.433	TCN	AP1636-H0	1.156	1.686	0.311	TCV
	AP8725-E1	0.969	2.125	0.276	TCV	AR1662-G0	1.180	1.590	0.410	TB4
	AP8725-E0	0.969	2.125	0.276	TCV	AR1662-G0	1.181	1.594	0.413	TB4
<b>TCV</b>  <b>50 PSI</b>	BP4612-E0	0.970	1.680	0.320	TCV/V	UP0223-E0	1.187	1.686	0.311	TCV
	BP4612-E0	0.970	1.685	0.327	TCV/V	BPP899-A0	1.187	1.686	0.311	TCV
	BP2807-F0	0.970	1.750	0.310	TCV	BR2203-E0	1.210	2.060	0.370	TB4
	BP2807-E0	0.970	1.750	0.310	TCV	BR2203-E0	1.216	2.061	0.374	TB4
	BP2807-E0	0.970	1.752	0.311	TCV	AR8946-E0	1.240	1.750	0.250	TB4
	BP2807-F0	0.970	1.752	0.311	TCV	AR1811-E0	1.240	1.880	0.390	TB4
	UP0551-E0	0.980	1.590	0.250	TCN	BP3468-E0	1.240	2.000	0.430	TCN
	UP0780-E0	0.983	1.732	0.276	TCV	AR1811-E0	1.246	1.890	0.394	TB4
<b>TB4</b>  <b>100 PSI</b>	UP0594-E0	0.984	1.596	0.252	TCN	BP3468-E0	1.248	2.008	0.433	TCN
	UP0551-E0	0.984	1.596	0.252	TCN	AR8946-E0	1.249	1.750	0.252	TB4
	UP0815-E0	0.990	2.125	0.311	TCV	BP1315-F0	1.250	1.749	0.252	TCV
	AP6994-G0	0.997	1.750	0.374	TCN	AP8540-E0	1.250	1.752	0.390	TCV
	UP0119-E0	1.000	1.499	0.252	TCV	BPP393-A0	1.250	1.752	0.390	TCV
	UP0284-E0	1.000	1.499	0.311	TCV	BP0191-E0	1.250	1.990	0.460	TCV
	AP8089-E0	1.000	1.575	0.315	TCV	BP0191-E0	1.253	1.996	0.469	TCV
	AP7926-F0	1.000	1.622	0.252	TCV/V	BP3490-E0	1.300	2.840	0.370	TCN
<b>TC4</b>  <b>100 PSI</b>	AP7926-G0	1.000	1.622	0.252	TCV	BP3490-E0	1.300	2.846	0.374	TCN
	AP1431-F0	1.000	1.624	0.311	TCN	UP0450-E0	1.300	2.846	0.374	TCN
	AR1432-E0	1.000	1.624	0.374	TB4	BPP944-A0	1.307	2.846	0.374	TCN
	AR1432-F0	1.000	1.624	0.374	TB4	AP7862-G0	1.310	1.930	0.310	TCV/V
	BP1660-E0	1.000	1.756	0.433	TCN	AP7772-G0	1.310	2.120	0.310	TCV/V
	BP0139-E1	1.000	1.811	0.433	TCN	AP7862-F0	1.313	1.936	0.311	TCV
	AP8090-E1	1.000	1.969	0.472	TCV	AP7862-G0	1.313	1.936	0.311	TCV/V
	AP7699-F0	1.060	1.680	0.310	TCV/V	AP7772-F0	1.313	2.125	0.311	TCV
<b>TCN</b>  <b>150 PSI</b>	BP1880-E0	1.060	1.820	0.270	TCV	AP7772-G0	1.313	2.125	0.311	TCV/V
	AP7861-G0	1.060	1.870	0.310	TCV/V	BR1578-E0	1.370	1.870	0.340	TB4/V
	BP1880-E0	1.062	1.827	0.276	TCV	BR1576-E0	1.370	1.870	0.340	TB4/V
	UP0177-E0	1.063	1.686	0.311	TCN	AR7053-E0	1.370	1.880	0.410	TC4
	AP7699-E0	1.063	1.686	0.311	TCV	BR0206-F0	1.370	1.960	0.390	TC4
	AP7699-F0	1.063	1.686	0.311	TCV/V	BP0208-E0	1.370	2.120	0.370	TCV/V
	AP7861-F0	1.063	1.875	0.311	TCV	BP0208-F0	1.370	2.120	0.370	TCV
	AP7861-G0	1.063	1.875	0.311	TCV/V	BP4570-E0	1.370	2.240	0.400	TCN

N.B.: MINIMUM LINE ORDER MAY APPLY

**Tel.: (888) 238-5885**  
**Fax: (888) 238-1664**

**SS 53**

[www.sealsonline.com](http://www.sealsonline.com)



**INCH SIZE  
SHAFT SEALS**



## PRESSURE SEALS - NOK

## NOK AVAILABILITY LIST







NOK Ref.	Dimensions			Design Type	NOK Ref.	Dimensions			Design Type	TB4  100 PSI
	d	D	H			d	D	H		
UP0449-E0	1.370	2.250	0.310	TCN/V	APP351-A0	1.625	2.375	0.374	TCV	TC4  100 PSI
BP0211-E0	1.370	2.250	0.310	TCV	APP351-B0	1.625	2.375	0.374	TCV/V	
AP7734-F0	1.372	2.127	0.437	TCN	BP1966-E0	1.626	2.382	0.311	TCV	TCN  150 PSI
BR1578-E0	1.374	1.875	0.346	TB4/V	BP4369-E0	1.627	2.373	0.453	TCN	
BR1576-E0	1.374	1.875	0.346	TB4/V	BP4745-E0	1.750	2.430	0.310	TCV/V	TCV  50 PSI
BR0206-F0	1.375	1.969	0.394	TC4	AP2583-E0	1.750	2.437	0.311	TCV	
BP0208-E0	1.375	2.124	0.374	TCV/V	AP2583-F0	1.750	2.437	0.311	TCV/V	TB4  100 PSI
BP0208-F0	1.375	2.124	0.374	TCV	BR2461-E0	1.750	2.441	0.433	TC4	
AP7175-E0	1.375	2.125	0.311	TCV	UP0445-E0	1.750	2.500	0.374	TCN/V	TCV  50 PSI
AP8212-E0	1.375	2.125	0.343	TCN	AP2585-F0	1.750	2.500	0.374	TCV	
AP8241-E1	1.375	2.125	0.374	TCV	BP4745-E0	1.751	2.436	0.315	TCV/V	TB4  100 PSI
APP348-A0	1.375	2.125	0.374	TCV	APP005-A0	1.772	2.677	0.472	TCV/V	
UP0449-E0	1.375	2.250	0.311	TCN/V	BR5250-F0	1.810	2.500	0.390	TB4	TB4  100 PSI
BP0211-E0	1.375	2.250	0.311	TCV	BR5250-E0	1.810	2.500	0.390	TB4/V	
BPP183-A0	1.375	2.250	0.327	TCV	BR5250-E0	1.811	2.501	0.394	TB4/V	TB4  100 PSI
BPP183-B0	1.375	2.250	0.327	TCV/V	BR5250-F0	1.811	2.501	0.394	TB4	
AP8242-E0	1.375	2.250	0.327	TCV	BR1974-E0	1.840	2.500	0.640	TB4	TB4  100 PSI
AR7053-E0	1.378	1.890	0.413	TC4	BR1974-E0	1.843	2.506	0.642	TB4	
BP4570-E0	1.378	2.249	0.402	TCN	AP2754-E1	1.870	2.620	0.500	TCN	TB4  100 PSI
AP8024-E0	1.430	1.870	0.250	TCV/V	AP2754-E1	1.875	2.625	0.500	TCN	
AP8243-F0	1.430	2.000	0.310	TCV/V	BP4797-E0	1.930	2.620	0.240	TCV/V	TB4  100 PSI
AP2183-F0	1.430	2.000	0.310	TCV	AP8244-E0	1.937	2.471	0.311	TCV	
AP8024-E0	1.437	1.875	0.252	TCV/V	AP8245-E0	1.937	2.625	0.252	TCV	TB4  100 PSI
AP2183-F0	1.437	2.000	0.311	TCV	BP4797-E0	1.938	2.624	0.248	TCV/V	
AP8243-E0	1.437	2.000	0.311	TCV	BR3658-E0	1.940	2.670	0.350	TC4	TC4  100 PSI
AP8243-F0	1.437	2.000	0.311	TCV/V	BR3658-E0	1.949	2.677	0.354	TC4	
AR6882-E0	1.500	2.000	0.410	TB4	BR5345-E0	2.000	3.000	0.472	TC4	TC4  100 PSI
AR6882-E0	1.500	2.000	0.413	TB4	BR0340-E0	2.110	2.870	0.470	TC4	
UP0234-F0	1.500	2.250	0.370	TCN/V	BR0340-E0	2.114	2.880	0.472	TC4	TC4  100 PSI
AP2281-E0	1.500	2.250	0.370	TCN	AP2994-E0	2.125	2.875	0.374	TCV	
AP2281-E0	1.500	2.250	0.374	TCN	BR0374-E0	2.250	2.877	0.335	TB4	TC4  100 PSI
UP0234-E0	1.500	2.250	0.374	TCN	BR1939-E0	2.250	2.953	0.433	TC4	
UP0234-F0	1.500	2.250	0.374	TCN/V	BP5155-E0	2.250	2.997	0.374	TCV	TCN  150 PSI
AP8215-E0	1.563	2.623	0.437	TCV	AP3132-E0	2.250	3.350	0.469	TCV	
BP1144-E0	1.570	2.370	0.370	TCN	BP3697-E0	2.370	3.560	0.310	TCV/V	TCV  50 PSI
BP1311-E0	1.575	2.375	0.374	TCN	BP3697-E0	2.378	3.563	0.315	TCV/V	
BP1144-E0	1.575	2.375	0.374	TCN	UP0762-E0	2.500	3.000	0.291	TCV	TB4  100 PSI
AP7270-F0	1.620	2.120	0.250	TCV/V	BR2434-E0	2.500	3.228	0.433	TC4	
AP7270-F1	1.620	2.120	0.250	TCV/V	AR6834-E0	2.750	3.250	0.492	TB4	TC4  150 PSI
AP2462-F0	1.620	2.370	0.370	TCV/V	AP8246-E0	2.750	3.751	0.626	TCV	
AP2462-G0	1.620	2.370	0.370	TCV	AR8809-P0	2.810	3.750	0.500	TC4	TCV  50 PSI
BP4369-E0	1.620	2.370	0.450	TCN	AR8809-P0	2.813	3.751	0.500	TC4	
BP1966-E0	1.620	2.380	0.310	TCV	AR3546-H0	2.870	3.750	0.500	TC4	TB4  100 PSI
AP7270-F0	1.625	2.125	0.252	TCV/V	AR3570-P0	2.870	3.750	0.500	TC4	
AP7270-F1	1.625	2.125	0.252	TCV/V	AR3570-P0	2.874	3.752	0.500	TC4	TC4  100 PSI
AP2462-E0	1.625	2.375	0.374	TCV	AR3546-H0	2.874	3.752	0.500	TC4	
AP2462-F0	1.625	2.375	0.374	TCV/V	BR2460-E0	3.000	3.740	0.430	TC4	TC4  100 PSI
AP2462-G0	1.625	2.375	0.374	TCV	BR2460-E0	3.000	3.740	0.433	TC4	

N.B.: MINIMUM LINE ORDER MAY APPLY

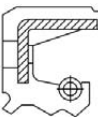
## NOK AVAILABILITY LIST

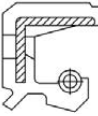
## PRESSURE SEALS - NOK

**INCH SIZE  
SHAFT SEALS**

<b>TB4</b>  <b>100 PSI</b>	NOK Ref.	Dimensions			Design Type	NOK Ref.	Dimensions			Design Type
		d	D	H			d	D	H	
<b>TC4</b>  <b>100 PSI</b>	BR0564-E0	3.250	4.000	0.390	TB4					
	BR0564-E0	3.252	4.000	0.394	TB4					
	BR0575-E0	3.360	4.120	0.370	TC4					
	BR0575-E0	3.362	4.130	0.378	TC4					
	BR2281-E0	3.500	4.252	0.433	TC4					
	BP0664-E0	4.000	5.000	0.626	TCN					
	BR2547-E0	4.240	5.240	0.500	TC4					
	BR2547-E0	4.248	5.248	0.500	TC4					
<b>TCN</b>  <b>150 PSI</b>	BR4489-E0	4.500	5.709	0.591	TC4					
	BR4497-E0	4.500	5.709	0.591	TC4					
	AP5000-E0	7.500	8.748	0.626	TCN					
	AP2169-E0	9.500	10.748	0.626	TCN					
<b>TCV</b>  <b>50 PSI</b>	BP5112-E0	9.500	10.874	0.622	TCN					
<b>TB4</b>  <b>100 PSI</b>										
<b>TC4</b>  <b>100 PSI</b>										
<b>TCN</b>  <b>150 PSI</b>										
<b>TCV</b>  <b>50 PSI</b>										

N.B.: MINIMUM LINE ORDER MAY APPLY

**Tel.: (204) 783-9617**  
**Fax: (204) 783-6091**

SS 55

[www.sealsonline.com](http://www.sealsonline.com)





### Rotational Pressure Seal for oil

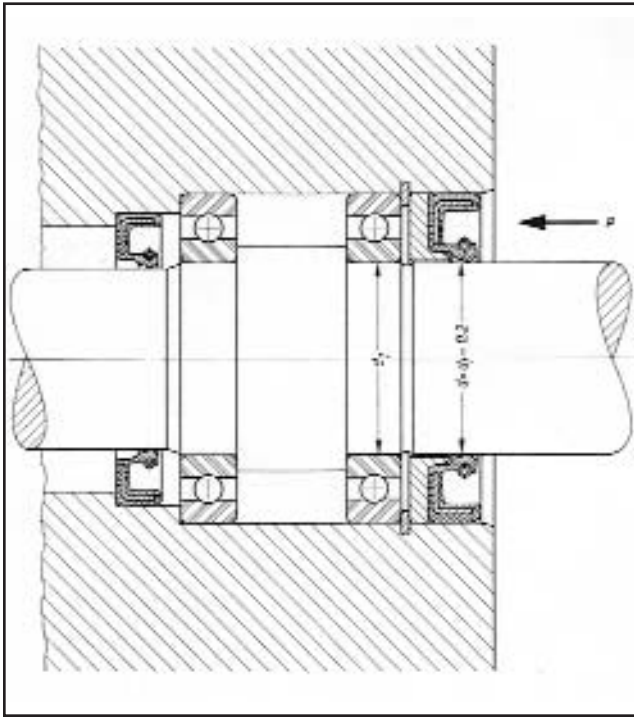

### Crankshaft Seal for two Stroke engine

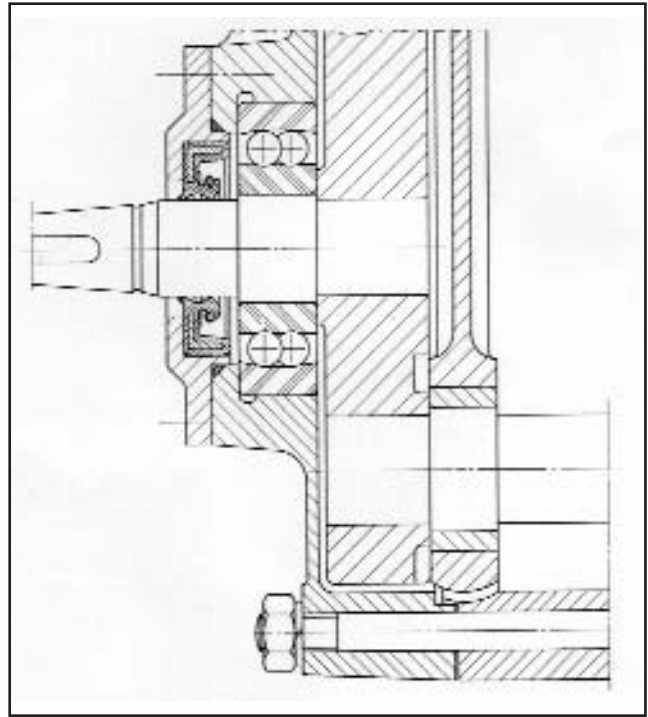

### Bearing Seal

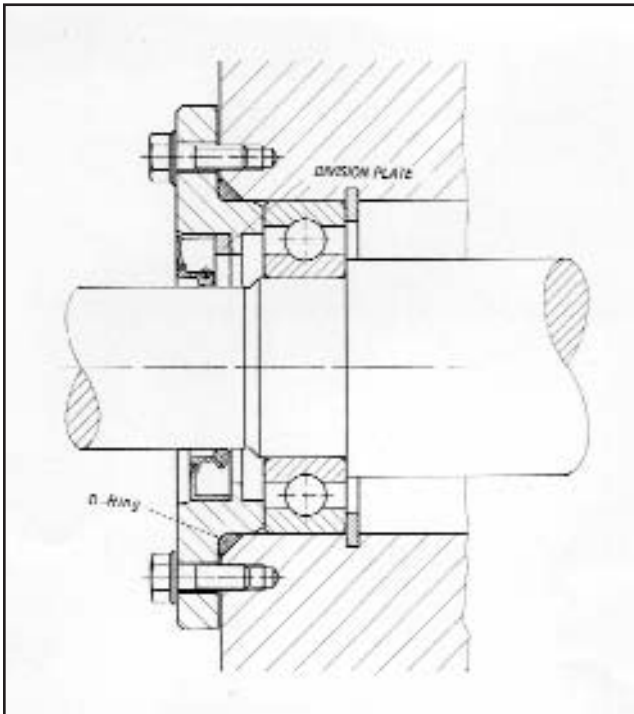

### Bearing Seal

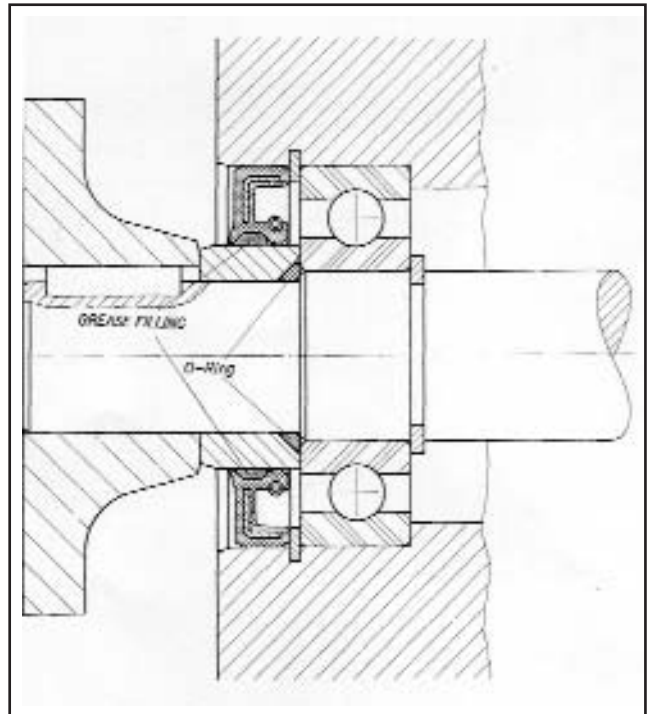

# SHAFT SEAL REFERENCE



*James Walker*<sup>®</sup>



INCH SIZE  
SHAFT SEALS

NOTE: These manufacturers are not necessarily represented by each location.

Tel.: (780) 414-1871  
Fax: (780) 487-5419

**SS 57**

[www.sealsonline.com](http://www.sealsonline.com)



## SHAFT SEAL REFERENCE - CR SEALS

INCH SIZE  
SHAFT SEALS

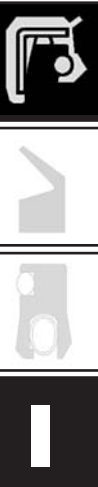
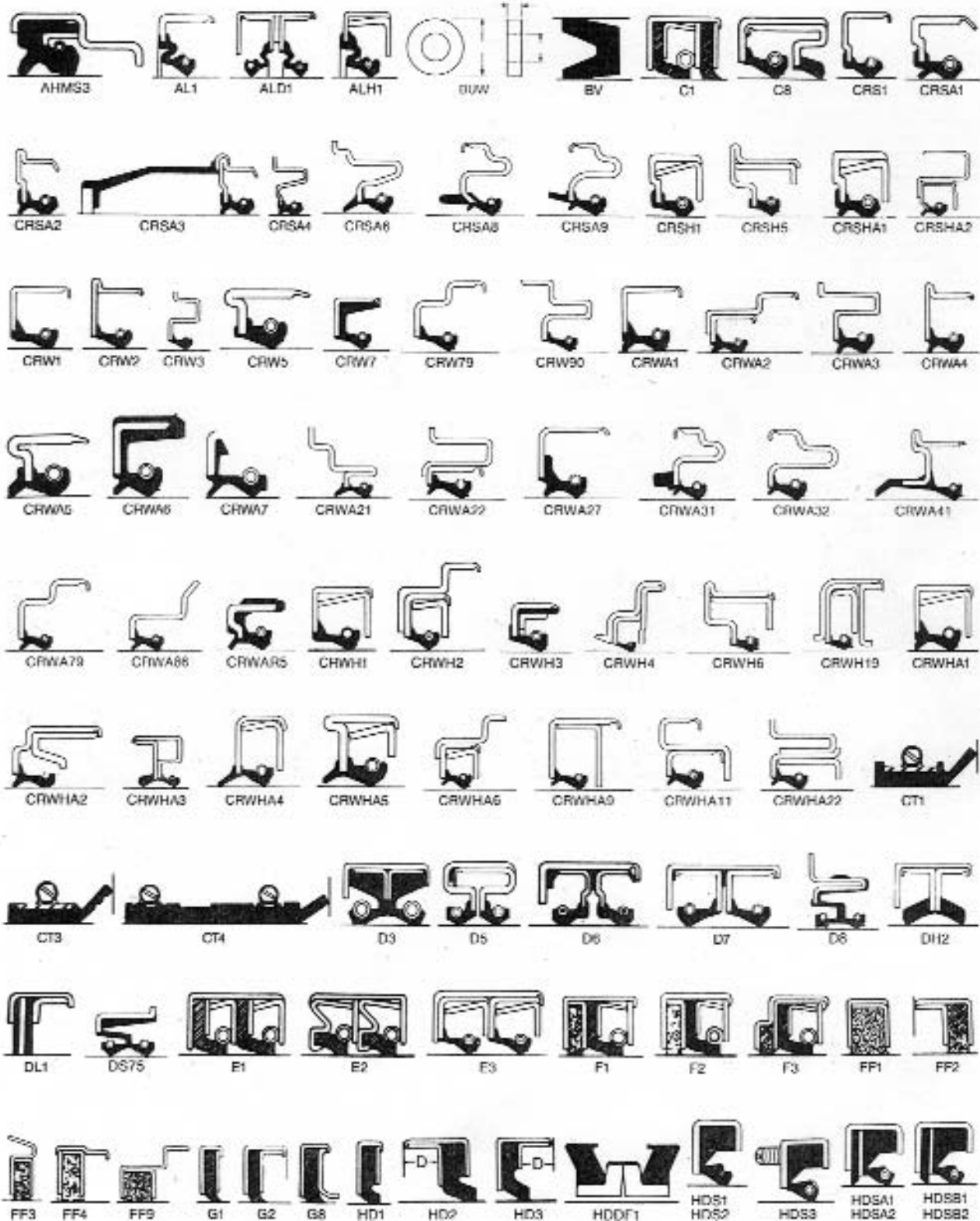

## SHAFT SEAL REFERENCE - CR SEALS

INCH SIZE  
SHAFT SEALS



## SHAFT SEAL REFERENCE - CR SEALS

INCH SIZE  
SHAFT SEALS

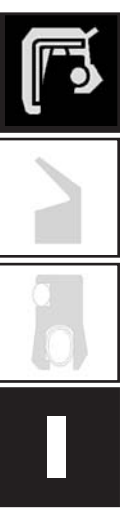

## SHAFT SEAL REFERENCE - GARLOCK

### Single Lip - Spring Loaded General Purpose Lubricant Retention Seals

INCH SIZE  
SHAFT SEALS

	Features	Shaft Diameters In. (MM)	Surface Speed FPM (MPS)	Misalignment & Runout In. @ FPM (MM @ MPS)	Spring	O.D. Construction
<b>MODEL 26</b> 	<ul style="list-style-type: none"> <li>General purpose, non-metallic seal</li> <li>Molded one-piece construction</li> </ul>	3/4 thru 60 (19.4 thru 1524)	5000 (25.4)	0.015 @ 1000 (0.38 @ 5.1)  0.010 @ 2000 (0.25 @ 10.2)  0.008 @ 5000 (0.20 @ 25.4)	Stainless Steel Finger	Rubber with reinforced heel
<b>MODEL 53</b> 	<ul style="list-style-type: none"> <li>Heavy duty case</li> <li>General purpose standard seal</li> <li>Assembled design</li> </ul>	3 thru 90 (76.2 thru 2286)	3000 (15.2)	0.015 @ 1000 (0.38 @ 5.1)  0.10 @ 2000 (0.25 @ 10.2)  0.005 @ 3000 (0.13 @ 15.2)	Stainless Steel Finger	Steel Case**
<b>MODEL 59</b> 	<ul style="list-style-type: none"> <li>Moderate to severe operating conditions</li> <li>Heavy duty metal case</li> <li>Assembled design</li> </ul>	6 thru 90 (152.4 thru 2286)	5000 (25.4)	0.093 Max. (2.36)	Stainless Steel Finger	Steel Case**
<b>MODEL 63</b> 	<ul style="list-style-type: none"> <li>Equivalent to Model 53</li> <li>Assembled design</li> </ul>	1/4 thru 3 (6.4 thru 76.2)	3000 (15.2)	0.015 @ 1000 (0.38 @ 5.1)  0.010 @ 2000 (0.25 @ 10.2)  0.005 @ 3000 (0.13 @ 15.2)	Stainless Steel Finger	Steel Case**
<b>MODEL 64*</b> 	<ul style="list-style-type: none"> <li>Severe service seal in steel mills, heavy equipment industry</li> <li>Assembled design</li> </ul>	8 thru 90 (203.2 thru 2286)	7000 (35.6)	0.125 @ 5000 (3.18 @ 25.4)  0.093 @ 7000 (2.36 @ 35.6)	Combination Carbon Steel* Garter and Stainless Steel Finger	Steel Outer Case** with Steel Inner Case†

FPM = feet per minute      MPS = meters per second

Standard sealing element is nitrile.  
 MILL-RIGHT®, silicone and fluoroelastomer available.  
 \*Stainless steel available on special order.  
 \*\*Plated cases available on special order. Special tooling may be required for stainless steel cases.  
 Aluminum and brass cases thru 19.999 inches (507.97 mm) O.D. on special order.  
 †Plated steel available on special order.



## SHAFT SEAL REFERENCE - GARLOCK



### Single Lip - Spring Loaded General Purpose Lubricant Retention Seals

	Features	Shaft Diameters In. (MM)	Surface Speed FPM (MPS)	Misalignment & Runout In. @ FPM (MM @ MPS)	Spring	O.D. Construction
<b>MODEL 66</b> 	<ul style="list-style-type: none"> <li>Equivalent to Model 76 with heavy duty case</li> <li>Assembled design</li> </ul>	3/8 thru 7-7/8 (9.5 thru 200)	3000 (15.2)	0.015 @ 1000 (0.38 @ 5.1)  0.010 @ 2000 (0.25 @ 10.2)  0.005 @ 3000 (0.13 @ 15.2)	Carbon Steel* Garter	Steel Case**
<b>MODEL 67</b> 	<ul style="list-style-type: none"> <li>General purpose</li> <li>Strong sealing element</li> <li>Assembled design</li> </ul>	1/2 thru 3-1/4 (12.7 thru 82.5)	1000 (5.1)	0.010 @ 500 (0.25 @ 2.5)  0.005 @ 1000 (0.13 @ 5.1)	Carbon Steel* Garter	Steel Case**
<b>MODEL 76</b> 	<ul style="list-style-type: none"> <li>General purpose</li> <li>Fits minimum space</li> <li>Bonded design</li> </ul>	1/4 thru 8 (6.4 thru 203.2)  limited sizes available	3000 (15.2)	0.015 @ 1000 (0.38 @ 5.1)  0.010 @ 2000 (0.25 @ 10.2)  0.005 @ 3000 (0.13 @ 15.2)	Carbon Steel* Garter	Steel Case
<b>MODEL 87</b> 	<ul style="list-style-type: none"> <li>Moderately severe service seal with rubber O.D. to ease installation</li> <li>Molded design</li> <li>Reverse bevel lip eliminates roll-over</li> </ul>	6 thru 48 (152.4 thru 1219.2)	5000 (25.4)	0.100 @ 2500 (2.54 @ 12.7)  0.050 @ 5000 (1.27 @ 25.4)	Carbon Steel Garter Encapsulated	Rubber Covered Steel Ring
<b>MODEL 88</b> 	<ul style="list-style-type: none"> <li>Moderately severe service seal with rubber O.D. to ease installation</li> <li>Molded design</li> <li>Reverse bevel lip eliminates roll-over</li> </ul>	6 thru 48 (152.4 thru 1219.2)	5000 (25.4)	0.050 @ 2500 (1.27 @ 12.7)  0.025 @ 5000 (0.64 @ 25.4)	Carbon Steel Garter Encapsulated	Rubber Covered Steel Ring
<b>MODEL 92</b> 	<ul style="list-style-type: none"> <li>Equivalent to Model 76 with rubber O.D. for non-ferrous housings</li> <li>Bonded design</li> </ul>	1/4 thru 12-1/2 (6.4 thru 317.5)  limited sizes available	3000 (15.2)	0.015 @ 1000 (0.38 @ 5.1)  0.010 @ 2000 (0.25 @ 10.2)  0.005 @ 3000 (0.13 @ 15.2)	Carbon Steel* Garter	Rubber Covered Steel Case

## SHAFT SEAL REFERENCE - GARLOCK

**Single Lip - No Spring - Retains Heavy Lubricants,  
Excludes Contaminants with Reverse Installation**

**INCH SIZE  
SHAFT SEALS**

	Features	Shaft Diameters In. (MM)	Surface Speed FPM (MPS)	Misalignment & Runout In. @ FPM (MM @ MPS)	Spring	O.D. Construction
<b>MODEL 58</b> 	<ul style="list-style-type: none"> <li>THERMO-CERAM™ sealing element withstands high temperatures, abrasive applications</li> <li>For reciprocating and rotating equipment</li> <li>Ideal for steel industry</li> </ul>	2 thru 12 (50.8 thru 305)	500 (2.5)	0.015 @ 500 (0.38 @ 2.5)	None	Steel Case
<b>MODEL 71</b> 	<ul style="list-style-type: none"> <li>General purpose standard seal</li> <li>Bonded design</li> </ul>	1/4 thru 7-1/4 (6.4 thru 184.2) limited sizes available	1000 (5.1)	0.005 @ 1000 (0.13 @ 5.1)	None	Steel Case
<b>MODEL 91</b> 	<ul style="list-style-type: none"> <li>Equivalent to Model 71 with rubber O.D. for non-ferrous housings</li> <li>Bonded design</li> </ul>	9/32 thru 5 (7.1 thru 127) limited sizes available	1000 (5.1)	0.005 @ 1000 (0.13 @ 5.1)	None	Rubber Covered Steel Case

FPM - feet per minute    MPS - meters per second

Standard sealing element is nitrile.  
Model 57 available in nitrile, silicone MILL-RIGHT® and fluoroelastomer.

\*Stainless steel available on special order

\*\*Plated cases available on special order. Special tooling may be required for stainless steel cases.

**Garlock**  
SEALING TECHNOLOGIES®

**Tel.: (514) 334-2220  
Fax: (514) 333-8329**

**SS**

**63**



[www.sealsonline.com](http://www.sealsonline.com)





## SHAFT SEAL REFERENCE - GARLOCK

**Dual Opposed Lips - Both Lips with Spring,  
Separates Lubricant from a Dissimilar Fluid**

	Features	Shaft Diameters In. (MM)	Surface Speed FPM (MPS)	Misalignment & Runout In. @ FPM (MM @ MPS)	Spring	O.D. Construction
<b>MODEL 53R2</b> 	<ul style="list-style-type: none"> <li>• Heavy duty case</li> <li>• Assembled design</li> </ul>	3 thru 15 (76.4 thru 381)	1000 (5.1)	0.010 @ 500 (0.25 @ 2.5)  0.005 @ 1000 (0.13 @ 5.1)	Stainless Steel Finger	Steel Case**
<b>MODEL 63R2</b> 	<ul style="list-style-type: none"> <li>• Equivalent to Model 53R2</li> <li>• Assembled design</li> </ul>	1/4 thru 3 (6.1 thru 76.2)	1000 (5.1)	0.010 @ 500 (0.25 @ 2.5)  0.005 @ 1000 (0.13 @ 5.1)	Stainless Steel Finger	Steel Case**

**Garlock**  
SEALING TECHNOLOGIES®

Standard sealing element is nitrile  
\*\*Plated cases available on special order. Special tooling may be required for stainless steel cases.







FPM = feet per minute

MPS = meters per second

## SHAFT SEAL REFERENCE - GARLOCK

**Dual Opposed Lips - One Lip with Spring, Sprung Lip Retains Lubricants, Un-Sprung Lip Excludes Contaminants**





**INCH SIZE  
SHAFT SEALS**

	Features	Shaft Diameters In. (MM)	Surface Speed FPM (MPS)	Misalignment & Runout In. @ FPM (MM @ MPS)	Spring	O.D. Construction
<b>MODEL 3</b> 	<ul style="list-style-type: none"> <li>• General purpose standard design</li> <li>• Bonded design</li> </ul>	1/2 thru 7-1/4 (12.7 thru 184.2)	4000 (20.3)	0.015 @ 1000 (0.38 @ 5.1)  0.010 @ 2000 (0.25 @ 10.2)  0.005 @ 4000 (0.13 @ 20.3)	Carbon Steel* Garter	Steel Case
<b>MODEL 26R1</b> 	<ul style="list-style-type: none"> <li>• General purpose, non-metallic seal</li> <li>• Molded one-piece construction</li> </ul>	3/4 thru 60 (19.4 thru 1524)	5000 (25.4)	0.015 @ 1000 (0.38 @ 5.1)  0.010 @ 2000 (0.25 @ 10.2)  0.008 @ 5000 (0.20 @ 25.4)	Stainless Steel Finger	Rubber with reinforced heel
<b>MODEL 53R1</b> 	<ul style="list-style-type: none"> <li>• Heavy duty case</li> <li>• Assembled design</li> <li>• Equivalent to Model 63R1</li> <li>• Assembled design</li> </ul>	53R1: 3 thru 15 (76.2 thru 381) 63R1: 1/4 thru 3 (6.4 thru 76.2)	2000 (10.2)	0.015 @ 1000 (0.38 @ 5.1)  0.10 @ 2000 (0.25 @ 10.2)	Stainless Steel Finger	Steel Case**
<b>MODEL 53F1</b> 	<ul style="list-style-type: none"> <li>• Felt element excludes contaminants</li> <li>• Equivalent to Model 63F1</li> <li>• Assembled design</li> </ul>	53F1: 3 thru 15 (76.2 thru 381) 63F1: 1/4 thru 3 (6.4 thru 76.2)	1000 (5.1)	0.010 @ 1000 (0.25 @ 5.1)	Stainless Steel Finger	Steel Case**
<b>MODEL 57</b> 	<ul style="list-style-type: none"> <li>• Slow speed applications</li> <li>• Caster applications</li> <li>• Available with single and dual lips</li> </ul>	2 thru 12 (50.8 thru 304.8)	500 (2.5)	0.015 @ 500 (0.38 @ 2.5)	Stainless Steel Finger	Rubber Covered Steel Case
<b>MODEL 94</b> 	<ul style="list-style-type: none"> <li>• Equivalent to Model 3 with rubber O.D. for non-ferrous housings</li> <li>• Bonded design</li> </ul>	7/16 thru 7-3/8 (11.1 thru 187.3)	3000 (15.2)	0.015 @ 1000 (0.38 @ 5.1)  0.10 @ 2000 (0.25 @ 10.2)  0.005 @ 3000 (0.13 @ 15.2)	Carbon Steel* Garter	Rubber Covered Steel Case



## SHAFT SEAL REFERENCE - GARLOCK

### Dual Tandem Lips Retains Lubricants

	Features	Shaft Diameters In. (MM)	Surface Speed FPM (MPS)	Misalignment & Runout In. @ FPM (MM @ MPS)	Spring	O.D. Construction
 <p><b>MODEL 53TB</b></p>	<ul style="list-style-type: none"> <li>Non-sprung front lip serves as a baffle</li> <li>Sprung back lip for effective sealing</li> <li>Assembled design</li> </ul>	3 thru 15 (76.2 thru 381)	1000 (5.1)	0.010 @ 500 (0.25 @ 2.5)  0.005 @ 1000 (0.13 @ 5.1)	Stainless Steel Finger	Steel Case**
 <p><b>MODEL 63TB</b></p>	<ul style="list-style-type: none"> <li>Non-sprung front lip serves as a baffle</li> <li>Sprung back lip for effective sealing</li> <li>Assembled design</li> </ul>	1/4 thru 3 (6.4 thru 76.2)	1000 (5.1)	0.010 @ 500 (0.25 @ 2.5)  0.005 @ 1000 (0.13 @ 5.1)	Stainless Steel Finger	Steel Case**
 <p><b>MODEL 53T2</b></p>	<ul style="list-style-type: none"> <li>Both lips have spring for effective sealing</li> <li>Assembled design</li> </ul>	3 thru 15 (76.2 thru 381)	1000 (5.1)	0.010 @ 500 (0.25 @ 2.5)  0.005 @ 1000 (0.13 @ 5.1)	Stainless Steel Finger	Steel Case*
 <p><b>MODEL 63T2</b></p>	<ul style="list-style-type: none"> <li>Both lips have spring for effective sealing</li> <li>Assembled design</li> </ul>	1/4 thru 3 (6.4 thru 76.2)	1000 (5.1)	0.010 @ 500 (0.25 @ 2.5)  0.005 @ 1000 (0.13 @ 5.1)	Stainless Steel Finger	Steel Case*

FPM = feet per minute      MPS = meters per second





Standard sealing element is nitrile.  
 \*Stainless steel available on special order.  
 \*\*Plated cases available on special order. Special tooling may be required for stainless steel cases.

**Garlock**  
SEALING TECHNOLOGIES®

## SHAFT SEAL REFERENCE - GARLOCK

### Single Lip Split - Retains Lubricants† Eliminates Costly Equipment Teardown

INCH SIZE  
SHAFT SEALS

	Features	Shaft Diameters In. (MM)	Surface Speed FPM (MPS)	Misalignment & Runout In. @ FPM (MM @ MPS)	Spring	O.D. Construction
<b>MODEL 21</b> 	<ul style="list-style-type: none"> <li>Low speed service seal</li> <li>Cover plate required for sealing installation</li> </ul>	3 thru 42 (76.2 thru 1066.8)	1000 (5.1)	0.010 @ 500 (0.25 @ 2.5)  0.005 @ 1000 (0.13 @ 5.1)	Molded in Stainless Steel Finger	Molded Rubber
<b>MODEL 23</b> 	<ul style="list-style-type: none"> <li>General purpose service seal</li> <li>Cover plate required for sealing installation</li> </ul>	3 and up (76.2 and up)	2000 (10.2)	0.010 @ 1000 (0.25 @ 5.1)  0.005 @ 2000 (0.13 @ 10.2)	Molded In Stainless Steel Finger	Molded Rubber
<b>MODEL 24</b> 	<ul style="list-style-type: none"> <li>Low speed service seal</li> <li>Tapered O.D. fits in tapered groove in housing</li> <li>Improved replacement for felt rings</li> </ul>	3 thru 21 1/2 (76.2 thru 546.1)	1000 (5.1)	0.010 @ 500 (0.25 @ 2.5)  0.005 @ 1000 (0.13 @ 5.1)	Molded in Stainless Steel Finger	Molded Rubber
<b>MODEL 25</b> 	<ul style="list-style-type: none"> <li>PTFE element for extremely severe chemicals</li> <li>Cover plate required for sealing</li> </ul>	3 thru 20 max. O.D. (76.2 thru 508)	1000 (5.1)	0.010 @ 500 (0.25 @ 2.5)  0.005 @ 1000 (0.13 @ 5.1)	Carbon Steel** Garter	PTFE
<b>MODEL 26</b> 	<ul style="list-style-type: none"> <li>General purpose non-metallic seal</li> <li>Molded one piece construction</li> <li>No cover plate required</li> <li>Reinforced heel</li> </ul>	1/4 thru 60 (19.4 thru 1524)	5000 (25.4)	0.015 @ 1000 (0.37 @ 5.1)  0.010 @ 2000 (0.25 @ 10.2)  0.008 @ 5000 (0.20 @ 25.4)	Stainless Steel Finger	Rubber with reinforced heel

Standard sealing element for Models 21, 23 and 24 is nitrile.

FPM - feet per minute

MPS - meters per second

MILL-RIGHT®, silicone and fluoroelastomer available.

Bonded spring in Models 21, 23 and 24 allows for simplified installation.



\*\*Stainless steel available on special order.

†Preformed applications on grease lubricated or liquid level below shaft centerline.



## SHAFT SEAL REFERENCE - GARLOCK

### External Lip Seals

	Features	Shaft Diameters In. (MM)	Surface Speed FPM (MPS)	Misalignment & Runout In. @ FPM (MM @ MPS)	Spring	O.D. Construction
 <p><b>MODEL 111</b></p>	<ul style="list-style-type: none"> <li>External lip seal</li> <li>Low speed service</li> <li>Assembled design</li> </ul>	3 thru 50 (76.2 thru 1270) limited sizes available	1000 (5.1)	0.010 @ 500 (0.25 @ 2.5) 0.005 @ 1000 (0.13 @ 5.1)	Stainless Steel Finger	Steel Case*
 <p><b>MODEL 113</b></p>	<ul style="list-style-type: none"> <li>External lip seal</li> <li>Moderate speed service</li> <li>Assembled design</li> </ul>	3 thru 50 (76.2 thru 1270) limited sizes available	3000 (15.2)	0.020 @ 1000 (0.50 @ 5.1) 0.10 @ 2000 (0.25 @ 10.2) 0.005 @ 3000 (0.13 @ 15.2)	Stainless Steel Finger	Steel Case*
 <p><b>MODEL 123</b></p>	<ul style="list-style-type: none"> <li>External lip seal</li> <li>Moderate speed service</li> <li>Assembled design</li> </ul>	1-5/32 thru 50 (29.4 thru 1270) limited sizes available	3000 (15.2)	0.020 @ 1000 (0.50 @ 5.1) 0.10 @ 2000 (0.25 @ 10.2) 0.005 @ 3000 (0.13 @ 15.2)	Stainless Steel Finger	Steel Case*

FPM = feet per minute    MPS = meters per second

Standard sealing element for Models 21, 23 and 24 is nitrile MILL-RIGHT®, silicone and fluoroelastomer available. Bonded spring in Models 21, 23 and 24 allows for simplified installation.

\*Stainless steel available on special order.

\*Preferred applications on grease lubricated or liquid level below shaft centerline.

**Garlock**  
SEALING TECHNOLOGIES®

## SHAFT SEAL REFERENCE - GARLOCK

### Miscellaneous Seals

INCH SIZE  
SHAFT SEALS

	Features	Shaft Diameters In. (MM)	Surface Speed FPM (MPS)	Misalignment & Runout In. @ FPM (MM @ MPS)	Spring	O.D. Construction
<b>MODEL 54</b> 	<ul style="list-style-type: none"> <li>• Seals spherical surface on self-aligning or spherical bearing</li> <li>• Excludes contaminants or fluids from bearing</li> <li>• Assembled design</li> </ul>	For spherical radii consult size listing on page 11	1000 (5.1)	Does not apply	Stainless Steel Finger	Steel Case**
<b>MODEL 61</b> 	<ul style="list-style-type: none"> <li>• PTFE element</li> <li>• Excellent chemical resistance</li> <li>• Recommended for small quantity requirements</li> <li>• Assembled design</li> <li>• Pressure to 150 psi</li> </ul>	7/16 thru 20 max seal O.D. (11.1 thru 508 max seal O.D.)	2000 (10.2)	0.005 @ 2000 (0.13 @ 10.2)	None	Steel Case**
<b>MODEL 62</b> 	<ul style="list-style-type: none"> <li>• PTFE element</li> <li>• Excellent chemical resistance</li> <li>• Recommended for small quantity requirements</li> <li>• Assembled design</li> </ul>	7/16 thru 20 max seal O.D. (11.1 thru 508 max seal O.D.)	2000 (10.2)	0.005 @ 2000 (0.13 @ 10.2)	Carbon Steel* Garter	Steel Case**
<b>MODEL 142</b> 	<ul style="list-style-type: none"> <li>• Seals on plane surface perpendicular to axis or shaft</li> <li>• Developed for steel mill service to shield bearing oil seals from contaminants</li> <li>• Assembled design</li> </ul>	7-1/2 min. (190.5 min.) Consult size listing on page 11	5000 (25.4)	Does not apply	Stainless Steel Finger	Steel Case**
<b>MODEL 145</b> 	<ul style="list-style-type: none"> <li>• Face type seal</li> <li>• High speed service</li> <li>• See page 11</li> </ul>	7 thru 80 (177.8 thru 2032)	5000 (25.4)	Does not apply	Stainless Steel Garter	Does not apply

FPM = feet per minute    MPS = meters per second

Model 54 standard sealing element is nitrile, silicone and fluorocopolymer available.  
 Model 142 available with nitric sealing element only.  
 Model 145 available in nitrile, MILL-RIGHT™ and fluorocopolymer  
 \*Stainless steel available on special order.  
 \*\*Plated cases available on special order. Special tooling may be required for stainless steel cases.



## SHAFT SEAL REFERENCE - GARLOCK

### Typical KLOZURE® Oil Seal Configurations

 3	 21	 23	 24	 25	 26
 26-R1	 53	 53-F1	 53-R1	 53-R2	 53-T2
 54	 57	 58	 59	 61	 62
 63	 63-F1	 63-R1	 63-R2	 63-T2	 63-TB
 64	 66	 67	 68	 71	 76
 87	 88	 91	 92	 94	 111
 113	 123	 142	 145	 ISO-GARD®	 VERTICAL ISO-GARD®
 ISO-GARD® GP	 FLANGELESS ISO-GARD®	 ISO-GARD® SPLIT PILLOW BLOCK	 FLANGED EQUALIZER®	 SPLIT PILLOW BLOCK EQUALIZER®	 FLANGELESS EQUALIZER®

INCH SIZE  
SHAFT SEALS



SHAFT SEAL REFERENCE - JAMES WALKER

# Walkersele



James Walker Manufacturing Company



**High Performance Rotary Shaft Lip Seals  
and Wipers For Pressurized  
and Non-Pressurized Services**

INCH SIZE  
SHAFT SEALS



Tel.: (604) 278-6808  
Fax: (604) 278-6180

**SS 71**

[www.sealsonline.com](http://www.sealsonline.com)



## SHAFT SEAL REFERENCE - JAMES WALKER

INCH SIZE  
SHAFT SEALS

Walkersele D6 & D7



### Walkersele™ Rotary Shaft Lip Seals Offering High Performance and ISO 9002 Certification

**D6** The most popular of the radial lip seals. The standard design is suitable for most applications, especially for sealing oil and grease lubricated bearings. The main features include:

- lip geometry which is designed to minimize heat generation and shaft wear
- optimum spring position which ensures uniform contact of lip on shaft
- flexible lip profile accommodates misalignment or shaft eccentricity.
- special high performance elastomers available, including fluoroelastomers (FKM) and HNBR.

Split seals available. Sizes available from 3/8" (10mm) shaft diameters upwards, with no maximum limit.

**D7** The D7 design forms a new part of the Walkersele range of lip seals for rotating shafts. It has a unique profile which has been developed to suit pressure applications. The main features include:

- costly profiled lip support plates not required.
- lip profile maintains shaft contact under conditions of misalignment or shaft eccentricity
- suitable for operating pressure up to 60 psi higher in some cases.
- full range of materials available, including special high performance elastomers such as fluoroelastomers (FKM or FKM) and HNBR
- extensive range of molded sizes available, from 1 1/4" (30mm) shaft diameters upwards, with no maximum limit.

**SURFACE RUBBING SPEED** The seal material should be selected to suit the shaft surface speed. Standard nitrile based materials are suitable for application speeds for D6 - 3600 ft/min (18 m/s); D7 - 2000 ft/min (10 m/s). Alternative materials should be considered for higher speeds, including fluoroelastomers which have been successfully used at speeds in excess of 5000 ft/min (25 m/s), and Elastolion HNBR.

**PRESSURE** Walkersele D6 design is not intended as a pressure seal. However, it can be used in conjunction with lip support rings for pressures up to 30 psi (2 bar). Machining details can be supplied on request. Where pressure is higher, the D7 design with pressures up to 60 psi (4 bar) should be used.

**TEMPERATURE** Nitrile rubber seals can be used for applications where the under-lip temperature does not exceed 240°F (120°C). For higher temperatures, alternative materials should be considered. Even with good lubrication and high heat dissipation, the lip temperature will be higher than the environmental temperature. Care should be exercised at temperatures above 180°F (80°C).

### Materials, Design and Construction

The following table outlines the range of materials most commonly used • Not all maximums can be combined at the same time.

Reference	Materials	Max. # Temp °F	Max. Speed - ft/min.		General Remarks
M1	Nitrile (NBR)	240	D6 3000	D7 2400	Our standard material suitable for most applications. A flexible rubberized fabric back and rubber lip. Cover plate required.
M6	Nitrile (NBR)	240	2400	2000	Incorporates an encapsulated steel band in the seal back. A self retaining seal suitable for housings without cover plates.
M8	Fluoroelastomer (FKM or FKM)	400	4000	3600	
M9	Fluoroelastomer (FKM or FKM)	400	5000	4400	As M1, but for higher speed applications. Cover plate required.
Elast-O-Lion®	Hydrogenated Nitrile (HNBR)	350	3000	2400	High strength elastomer suitable for more aggressive applications including those where additional wear and abrasion resistance is required.
Fluonion®	PTFE	500	600	consult	Right plastic material used for chemical and food processing applications.

## SHAFT SEAL REFERENCE - JAMES WALKER

INCH SIZE  
SHAFT SEALS

### D6 and D7 Seals are Available to Suit Two Types of Housing

#### Retained Seals

D6

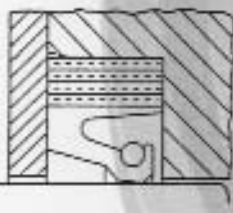

D7

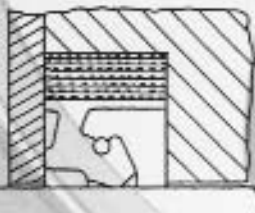

These seals must be used in housings fitted with cover plates. Our standard material seals should be fitted in this way. Such seals can be supplied in split form.

#### Self-Retaining Seals

D6

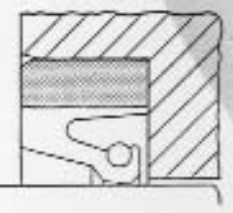

D7



The D6 & D7 seals may be fitted without retaining plates, but the D7 style must be fully supported, as shown, to contain pressure.

### Ease of Fitting

Ease of installation is a prime consideration for all Walkersele products. Unlike rigid metal backed seals, the total flexibility of the Walkersele allows for easy fitting and removal. To reduce fitting time, retained seals can be supplied in split form (The split D7 is not intended for pressure applications. We suggest the Walkersele OSJ (on-site join) to ensure endless seal integrity.) A solid rubber portion is included in the seal back through which the split is made. The close mating of the ends ensures that a potential leakage path is closed.

### Seal Lubrication for D6

When two or more seals are fitted in the same housing and interseal lubrication is required, access ports, and, where necessary, an annular groove can be incorporated into the seal base. Seals featuring this design modification are available on request.

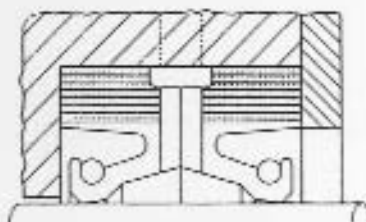
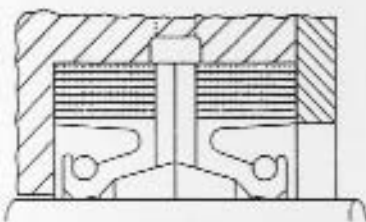

## SHAFT SEAL REFERENCE - JAMES WALKER

### Recommended Housing For New Designs

**D6** For guidance purposes our recommended housing sizes for given shaft diameters are:

SELF RETAINING SEALS (M2, M5 & M8)					
Shaft Dia 'A'		Nominal Housing Sizes			
		Depth 'C'		Section 'D'	
mm	inch	mm	inch	mm	inch
up to 62.5	up to 2 1/2	10	3/8	10	3/8
over 62.5 to 100	over 2 1/2 to 4	12.5	1/2	12.5	1/2
over 100 to 250	over 4 to 10	15	5/8	15	5/8
over 250 to 400	over 10 to 16	20	3/4	20	3/4
over 400 to 600	over 16 to 24	22	7/8	22	7/8
over 600 to 900	over 24 to 35 1/2	25	1	25	1

\*Standard seals to charts 104, 105 and 375 will not necessarily conform to these recommendations please see dimensions shown on pages 8 and 9.

SEALS WITH RETAINING PLATE					
Shaft Dia 'A'		Nominal Housing Sizes			
		Depth 'C'		Section 'D'	
mm	inch	mm	inch	mm	inch
up to 35	up to 1 3/8	10	3/8	11	7/16
over 35 to 62.5	over 1 3/8 to 2 1/4	11	7/16	12.5	1/2
over 62.5 to 100	over 2 1/4 to 4	12.5	1/2	16	5/8
over 100 to 250	over 4 to 10	16	5/8	20	3/4
over 250 to 400	over 10 to 16	20	3/4	22	7/8
over 400 to 600	over 16 to 24	22	7/8	25	1
over 600	over 24	25	1	32	1 1/4

### D7

SEALS WITH RETAINING PLATE					
Shaft Diameter 'A'		Nominal Housing			
ø	ø	Depth 'C'		Section 'D'	
30	100	15		17.5	
100	250	16		20	
250	400	20		22	
400	600	22		25	
600		25		32	

SELF-RETAINING SEALS (M2, M6, M8)					
Shaft Diameter 'A'		Nominal Housing			
ø	ø	Depth 'C'		Section 'D'	
30	250	15		15	
250	330	16		17.5	
330	450	20		20	
450	600	22		25	
600		25		30	

### Seal Type M1/D6 Chart 56

JW Part No.	Shaft Dia A	Housing Dia B	Housing Depth C
56-100	1	1 1/8	3/8
56-112	1 1/2	2	3/8
56-125	1 1/4	2 1/8	3/16
56-137	1 3/8	2 1/4	3/8
56-150	1 1/2	2 1/2	7/16
56-162	1 5/8	2 3/8	7/16
56-175	1 3/4	2 3/4	7/16
56-187	1 7/8	2 7/8	7/16
56-200	2	3	7/16
56-212	2 1/8	3 1/8	7/16
56-225	2 1/4	3 1/4	7/16
56-237	2 3/8	3 3/8	7/16
56-250	2 1/2	3 1/2	7/16
56-275	2 3/4	4	1/2
56-300	3	4 1/4	1/2
56-325	3 1/4	4 1/2	1/2
56-350	3 1/2	4 3/4	1/2
56-375	3 3/4	5	1/2
56-400	4	5 1/4	1/2
56-425	4 1/8	5 7/8	5/8
56-450	4 1/2	6	3/4
56-475	4 3/4	6 1/4	5/8
56-500	5	6 1/2	3/4
56-525	5 1/4	6 7/8	3/4
56-550	5 1/2	7	3/4
56-575	5 3/4	7 1/4	5/8
56-600	6	7 1/2	3/4
56-625	6 1/4	7 3/4	5/8
56-650	6 1/2	8	3/4
56-675	6 3/4	8 1/4	5/8
56-700	7	8 1/2	3/4
56-725	7 1/2	9	5/8
56-800	8	9 1/2	3/4
56-850	8 1/2	10	5/8
56-900	9	10 1/2	3/4
56-950	9 1/2	11	5/8
56-1000	10	11 1/2	3/4
56-1050	10 1/2	12 1/4	3/4
56-1100	11	12 3/4	3/4
56-1150	11 1/2	13 1/4	3/4
56-1200	12	13 3/4	3/4
56-1300	13	14 3/4	3/4
56-1400	14	15 3/4	3/4
56-1500	15	16 3/4	3/4

All dimensions in mm

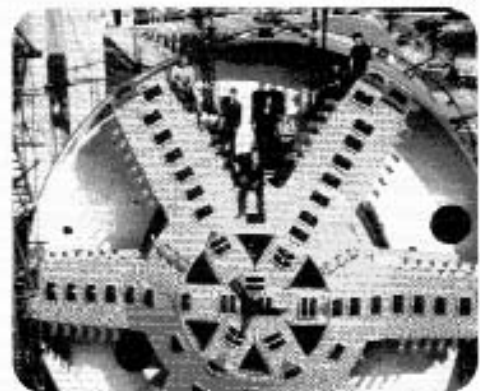

Walkersele D6 & D7

INCH SIZE  
SHAFT SEALS



## SHAFT SEAL REFERENCE - JAMES WALKER

Seal Type M1/D6 Chart 57			
JW Part No.	Shaft Dia A	Housing Dia B	Housing Depth C
57-25	25	47	10
57-30	30	52	10
57-32	32	54	10
57-35	35	57	10
57-38	38	63	11
57-40	40	65	11
57-42	42	67	11
57-43	43	68	11
57-45	45	70	11
57-50	50	75	11
57-53	53	78	11
57-55	55	80	11
57-58	58	83	11
57-60	60	85	11
57-65	65	90	11
57-68	68	100	12.5
57-70	70	102	12.5
57-73	73	105	12.5
57-75	75	107	12.5
57-80	80	112	12.5
57-82	82	114	12.5
57-85	85	117	12.5
57-88	88	120	12.5
57-90	90	122	12.5
57-93	93	125	12.5
57-95	95	127	12.5
57-97	97	129	12.5
57-100	100	132	12.5
57-105	105	145	16
57-110	110	150	16
57-115	115	155	16
57-120	120	160	16
57-125	125	165	16
57-130	130	170	16
57-135	135	175	16
57-140	140	180	16
57-145	145	185	16
57-150	150	190	16
57-155	155	195	16
57-160	160	200	16
57-165	165	205	16
57-166	166	206	16
57-170	170	210	16
57-175	175	215	16
57-180	180	220	16
57-185	185	225	16
57-190	190	230	16
57-195	195	235	16
57-200	200	240	16
57-205	205	245	16
57-210	210	250	16
57-215	215	255	16
57-220	220	260	16
57-225	225	265	16

Seal Type M1/D6 Chart 57 <small>(continued)</small>			
JW Part No.	Shaft Dia A	Housing Dia B	Housing Depth C
57-230	230	270	16
57-235	235	275	16
57-240	240	280	16
57-245	245	285	16
57-250	250	290	16
57-255	255	299	20
57-260	260	304	20
57-265	265	309	20
57-270	270	314	20
57-275	275	319	20
57-280	280	324	20
57-285	285	329	20
57-290	290	334	20
57-295	295	339	20
57-296	296	340	20
57-300	300	344	20
57-305	305	349	20
57-310	310	354	20
57-320	320	364	20
57-325	325	369	20
57-330	330	374	20
57-340	340	384	20
57-350	350	394	20
57-360	360	404	20
57-370	370	414	20
57-380	380	424	20
57-390	390	434	20
57-400	400	444	20
57-413	413	463	22
57-420	420	470	22
57-430	430	480	22
57-440	440	490	22
57-450	450	500	22
57-455	455	505	22
57-460	460	510	22
57-475	475	525	22
57-480	480	530	22
57-485	485	535	22
57-500	500	550	22
57-530	530	580	22
57-540	540	590	22
57-560	560	610	22
57-580	580	630	22
57-600	600	650	22
57-650	650	714	25
57-660	660	724	25
57-700	700	764	25
57-750	750	814	25
57-790	790	854	25
57-800	800	864	25
57-820	820	884	25
57-830	830	894	25
57-970	970	1034	25
57-1000	1000	1064	25

All dimensions in mm

INCH SIZE  
SHAFT SEALS



## SHAFT SEAL REFERENCE - JAMES WALKER

INCH SIZE  
SHAFT SEALS

Walkersele D6 & D7

Seal Type M6/D6 Chart 104			
JW Part No.	Shaft Dia A	Housing Dia B	Housing Depth C
104-200	2	3	1/16
104-212	2 1/16	3 1/8	1/16
104-225	2 1/4	3 1/4	7/16
104-237	2 3/8	3 3/8	7/16
104-250	2 1/2	3 1/2	1/16
104-275	2 3/4	4	1/2
104-300	3	4 1/4	1/2
104-325	3 1/4	4 1/2	1/2
104-350	3 1/2	4 3/4	1/2
104-375	3 3/4	5	1/2
104-400	4	5 1/4	1/2
104-425	4 1/4	5 3/4	3/8
104-450	4 1/2	6	3/8
104-475	4 3/4	6 1/4	3/8
104-500	5	6 1/2	3/8
104-525	5 1/4	6 3/4	3/8
104-550	5 1/2	7	3/8
104-575	5 3/4	7 1/4	3/8
104-600	6	7 1/2	3/8
104-625	6 1/4	7 3/4	3/8
104-650	6 1/2	8	3/8
104-675	6 3/4	8 1/4	3/8
104-700	7	8 1/2	3/8
104-750	7 1/2	9	3/8
104-800	8	9 1/2	3/8
104-850	8 1/2	10	3/8
104-900	9	10 1/2	3/8
104-950	9 1/2	11	3/8
104-1000	10	11 1/2	3/8
104-1050	10 1/2	12 1/4	3/4
104-1100	11	12 3/4	3/4
104-1150	11 1/2	13 1/4	3/4
104-1200	12	13 3/4	3/4
104-1300	13	14 3/4	3/4
104-1400	14	15 3/4	3/4
104-1500	15	16 3/4	3/4

All dimensions in inches

Seal Type M6/D6 Chart 105			
JW Part No.	Shaft Dia A	Housing Dia B	Housing Depth C
105-50	50	75	11
105-55	55	80	11
105-60	60	85	11
105-65	65	90	11
105-70	70	102	12.5
105-75	75	107	12.5
105-80	80	112	12.5
105-85	85	117	12.5
105-90	90	122	12.5
105-95	95	127	12.5
105-100	100	132	12.5
105-105	105	145	16
105-110	110	150	16
105-115	115	155	16
105-120	120	160	16
105-125	125	165	16
105-130	130	170	16
105-135	135	175	16
105-140	140	180	16
105-145	145	185	16
105-150	150	190	16
105-160	160	200	16
105-170	170	210	16
105-180	180	220	16
105-190	190	230	16
105-200	200	240	16
105-210	210	250	16
105-220	220	260	16
105-230	230	270	16
105-240	240	280	16
105-250	250	290	16
105-260	260	304	20
105-270	270	314	20
105-280	280	324	20
105-290	290	334	20
105-300	300	344	20
105-310	310	354	20
105-320	320	364	20
105-330	330	374	20
105-340	340	384	20
105-350	350	394	20
105-360	360	404	20
105-370	370	414	20
105-380	380	424	20
105-390	390	434	20
105-400	400	444	20
105-420	420	470	22
105-440	440	490	22
105-460	460	510	22
105-480	480	530	22
105-500	500	550	22

All dimensions in mm

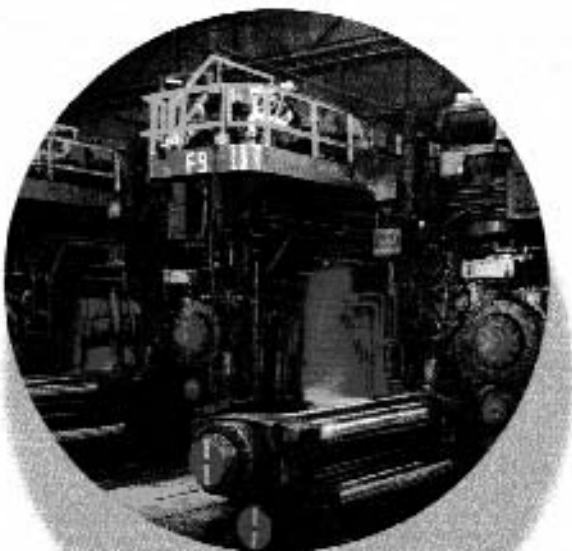

## SHAFT SEAL REFERENCE - JAMES WALKER



### Ease of Fitting

Ease of fitting is a prime consideration for all Walkersels products. Unlike rigid metal backed seals, the total flexibility of the Walkersel allows for easy fitting and removal. To reduce fitting time, retained seals can be fitted in split form; however, as the D7 design is intended for pressure applications, we recommend the use of Walkersel OSJ (on-site join) so as to ensure endless seal integrity. A separate brochure is available describing this product.

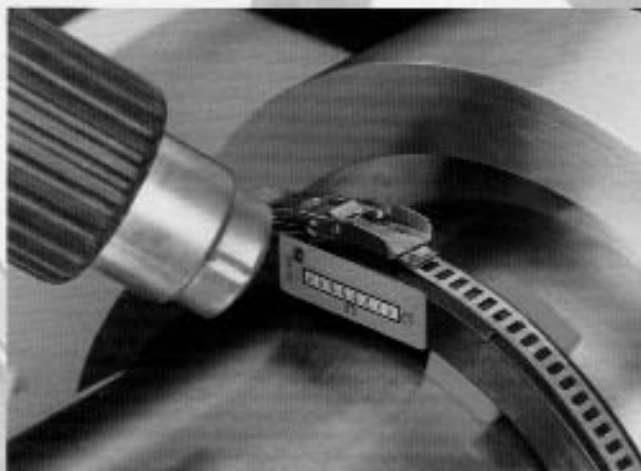

INCH SIZE  
SHAFT SEALS

Seal Type M6/D6 Chart 376			
JW Part No.	Shaft Dia A	Housing Dia B	Housing Depth C
376-062085	62	85	10
376-062090	62	90	10
376-063085	63	85	10
376-063090	63	90	10
376-065085	65	85	10
376-065090	65	90	10
376-065100	65	100	10
376-068090	68	90	10
376-068100	68	100	10
376-070090	70	90	10
376-070095	70	95	10
376-070100	70	100	10
376-072095	72	95	10
376-072100	72	100	10
376-075095	75	95	10
376-075100	75	100	10
376-078100	78	100	10
376-080100	80	100	10
376-080110	80	110	10
376-085110	85	110	12
376-085120	85	120	12
376-090110	90	110	12
376-090120	90	120	12
376-095120	95	120	12
376-095125	95	125	12
376-100120	100	120	12
376-100125	100	125	12
376-100130	100	130	12
376-105130	105	130	12
376-105140	105	140	12
376-110130	110	130	12
376-110140	110	140	12
376-115140	115	140	12
376-115150	115	150	12

Seal Type M6/D6 Chart 376 <small>continued</small>			
JW Part No.	Shaft Dia A	Housing Dia B	Housing Depth C
376-120150	120	150	12
376-120160	120	160	12
376-125150	125	150	12
376-125160	125	160	12
376-130160	130	160	12
376-130170	130	170	12
376-135170	135	170	12
376-140170	140	170	15
376-145175	145	175	15
376-150180	150	180	15
376-160190	160	190	15
376-170200	170	200	15
376-180210	180	210	15
376-190220	190	220	15
376-200230	200	230	15
376-210240	210	240	15
376-220250	220	250	15
376-230260	230	260	15
376-240270	240	270	15
376-250280	250	280	15
376-260300	260	300	20
376-280320	280	320	20
376-300340	300	340	20
376-320360	320	360	20
376-340380	340	380	20
376-360400	360	400	20
376-380420	380	420	20
376-400440	400	440	20
376-420460	420	460	20
376-440480	440	480	20
376-460500	460	500	20
376-480520	480	520	20
376-500540	500	540	20

All dimensions in mm



## SHAFT SEAL REFERENCE - JAMES WALKER

INCH SIZE  
SHAFT SEALS

Walkersele D6 & D7



### Using Walkerseles as Ram/Rod Wipers

Walkerseles in split or solid form are frequently used as wipers or scrapers to prevent contamination or foreign particles from entering a hydraulic system. In such cases we recommend the LR6364/D5 design, on all rubber/fabric products with a springless lip. This combination will wipe a reciprocating ram clean without harming the surface or allowing the lip to fold back.

The recommended cross-section and height dimensions are the same as for D6 Walkerseles. However, for existing housings, most cross sections can be supplied with heights varying as required. In a number of cases, a single D5 Walkersele has replaced two competitor's seals with equal or better performance.

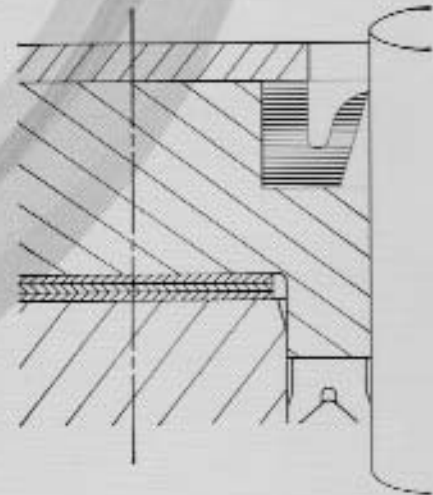

# JAMES WALKER MFG CO.

SHAFT SEAL REFERENCE - JM CLIPPER

# OIL SEAL SOLUTIONS WORLDWIDE

• CLIPPER OIL SEALS • SPLIT SEALS • HIGH AND MEDIUM PRESSURE SEALS •

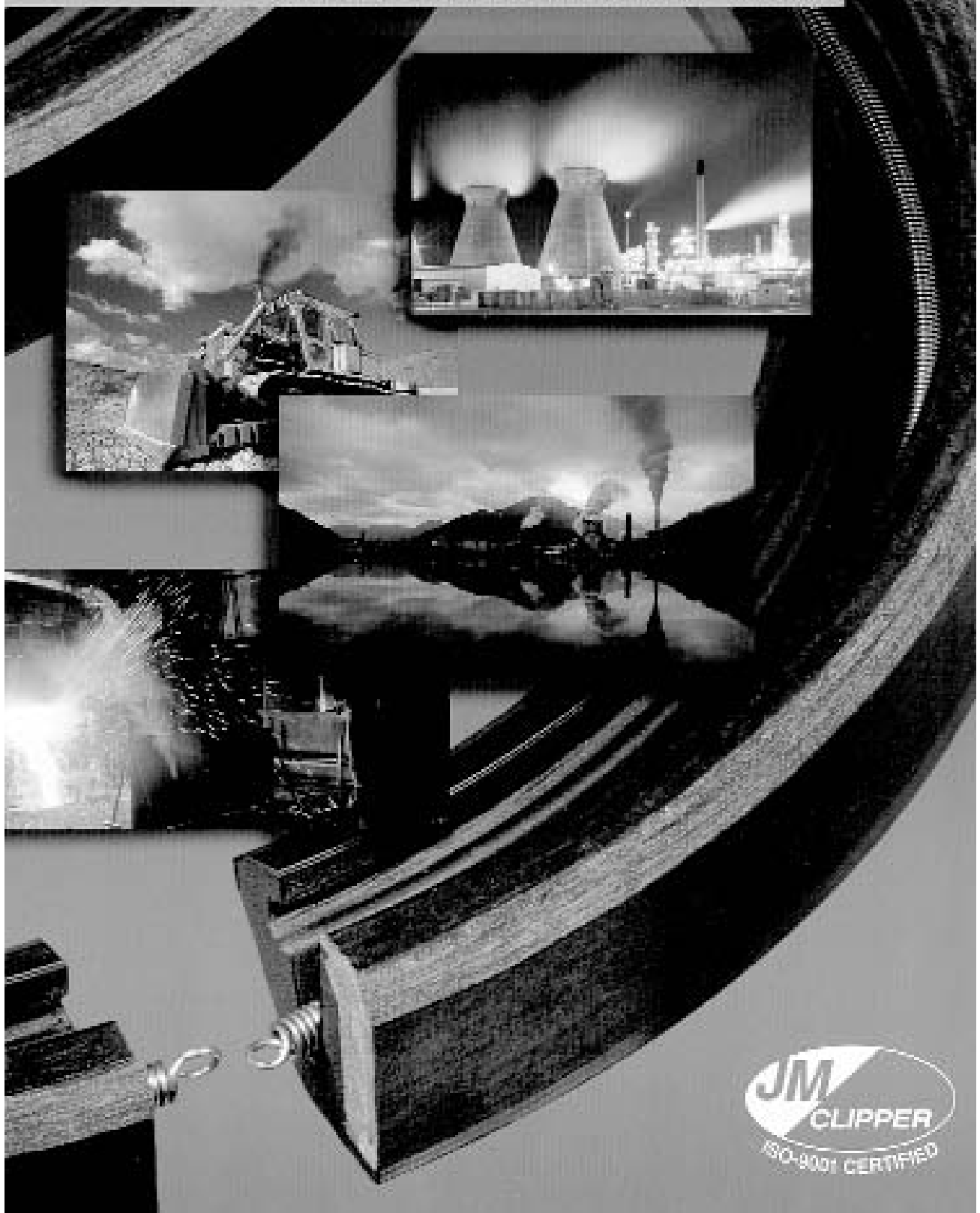

INCH SIZE  
SHAFT SEALS



Tel.: (204) 783-9617  
Fax: (204) 783-6091

**SS 79**

[www.sealsonline.com](http://www.sealsonline.com)



## SHAFT SEAL REFERENCE - JM CLIPPER

# EXPERIENCE, EXPERTISE, SOLUTIONS



JM Clipper is a world leader in formulating highly-effective solutions to sealing problems throughout industry. Few companies can match JM Clipper's expertise and experience in developing products for OEM and plant applications. Clipper Oil Seals are used in a wide range of equipment from pumps and gear boxes to construction and mining machinery to industrial equipment. These highly-effective seals are also used in plants in virtually every industry including primary metals, pulp and paper, chemicals and petrochemical, power generation, and more.

### Solving Problems High Over the Pacific

The JM Clipper name began in the 1990s with the development of the Clipper Oil Seal to control engine oil leaks on Pan Am Clipper aircraft flying the Pacific. As a division of Johns Manville until 1989, JM Clipper's history goes back to the 1800s. Today, JM Clipper brings sealing solutions to 500 OEMs and thousands of industrial plants through its own dedicated sales force and 2,000 independent distributors.



*A world leader in formulating highly-effective solutions to sealing problems*

### Non-Metallic Clipper Oil Seals

JM Clipper's proprietary design is based on a rubber/fiber outer case and elastomeric inner lip integrally molded to form a leak-free bond. A stainless steel garter spring provides the correct interference with the rotating shaft for an effective seal. Clipper Oil Seals are available in over 10,000 styles and sizes in a variety of compounds including fluoroelastomers.

### Specialized Radial Seals

In addition to standard Clipper Oil Seals, JM Clipper pioneered factory-split oil seals for fast, easy in-plant installation with no special tools or equipment modification. JM Clipper H/P and MP seals combine elastomers and metal shells for superior O.D. sealing and performance in high and medium pressure applications. SlipTite™ high performance seals handle shaft speeds up to 5,000 fpm. For sealing performance beyond radial lip seals, JM Clipper developed ProTech™, a new kind of PTFE labyrinth seal.

### ISO-9001 Certification

In 1994, Det Norske Veritas Industries of the Netherlands completed its ISO audit and JM Clipper gained ISO 9001 certification for manufacturing, product design, and engineering which adds yet a higher level of quality assurance.



## SHAFT SEAL REFERENCE - JM CLIPPER



**INCH SIZE  
SHAFT SEALS**

### Non-Metallic Advantages

The unique non-metallic construction of Clipper Oil Seals offers important benefits over metal-cased seals before installation, during installation, and throughout the life of the seal.

#### Clipper Characteristics

Aramid fiber-reinforced composite

Integrally molded unit

Stainless steel garter spring

Specially-formulated elastomer lip with designed flexibility

#### Advantages

- Fits a wider range of bore tolerances and finishes, resulting in lower machining costs and easier installation
- Resists corrosion
- Takes more abuse, eliminating damage
- Gives better I.D. to O.D. concentricity resulting in less potential leakage and shaft wear
- Provides more uniform lip load
- Resists corrosion
- Minimizes friction resulting in less shaft wear
- Follows shaft eccentricity

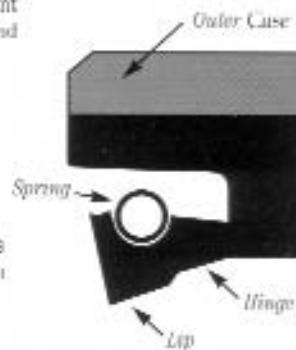

### Comparison of Non-Metallic and Metal-Cased Seals

Key Benefits	Non-Metallic Clipper Oil Seals	Metal-Cased Seals
Corrosion Resistance	Yes	No
Positive O.D. Sealability	Yes	No
Durability and Damage Resistance	Yes	No
Easy Installation with No Special Skills or Tools	Yes	No
Built In Interference	Yes	Yes
Sizes to Fit Most Industrial Applications	Yes	Yes
Wearability/Long Life	Yes	Yes
Split Styles without Cover Plate	Yes	No



*Non-metallic  
Clipper Oil Seals are  
available in over  
10,000 styles  
and sizes*



## SHAFT SEAL REFERENCE - JM CLIPPER

# STANDARD SEALS





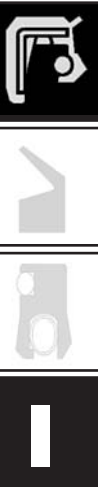



INCH SIZE  
SHAFT SEALS

Cross Section	Type	Application	Shaft Surface Speed (m/min)	Shaft Size Range Inches (mm)
	LUP	General Purpose.	Thru 3200 FPM (976)	5"-60" (127-1524)
	LPD Without Spring Retainer	General Purpose.	Thru 3200 FPM (976)	5"-60" (127-1524)
	LPD With Spring Retainer	General Purpose.	Thru 3200 FPM (976)	5"-60" (127-1524)
	MIST	Heavy Duty Steel Mill Roll Neck Bearing Service. Steel bands offer greater retention in the bore. Molded in spring eliminates spring dumping.	Thru 3200 FPM (976)	5"-50" (127-1270)
	RIT	General Purpose. Split design.	Thru 2000 FPM (610)	1 1/2"-60" (38-1524)
	RPD	General Purpose. Split design.	Thru 2000 FPM (610)	1 1/2"-60" (38-1524)
	SS	General Purpose. Springless - for small flange dimensions.	Thru 2000 FPM (610)	5"-6" (127-152)
	ST-LUP	Heavy Duty Steel Mill Roll Neck Bearing Service. Steel bands offer greater retention in the bore.	Thru 3200 FPM (976)	5" 50" (127 1270)
	ST-LPD	Heavy Duty Steel Mill Roll Neck Bearing Service. Steel bands offer greater retention in the bore.	Thru 3200 FPM (976)	5" 50" (127 1270)
	OL	Outside lip design.	Thru 1000 FPM (306)	5"-50" (127-1270)



## SHAFT SEAL REFERENCE - JM CLIPPER

INCH SIZE  
SHAFT SEALS

Cross Section	Type	Application	Shaft Surface Speed (m/min)	Shaft Size Range Inches (mm)
	LXS	General Purpose. Dual lip used against fluid & dust conditions.	Thru 2500 FPM (762)	3/8"-26" (10-635)
	SDS	General Purpose. Dual lip springless for small shaft sizes.	Thru 2000 FPM (610)	3/8"-26" (10-635)
	LUPW	Oscillating or angular movement at low surface speed.	Thru 1000 FPM (306)	1 1/2"-50" (41-1270)
	LPTW	Oscillating or angular movement at low surface speed.	Thru 1000 FPM (306)	1 1/2"-50" (41-1270)
	P	Shallow Cavity Rod Wiper for reciprocating service.	Thru 800 FPM Reciprocating (92)	3/8"-30" (10-762)
	H	General Purpose Rod Wiper Seal for rotary or reciprocating service.	Thru 2000 FPM (610) Rotary. Thru 800 (92) FPM Reciprocating.	3/8"-30" (10-762)
	DS	Baffle or Deflector.	Thru 2500 FPM (762)	3/8"-15" (10-381)
	SSW	Face Sealing Excluder.	Thru 2500 FPM (762)	1"-25" (25-635)
	RPDY	All compound split seal with Tapered Beel.	Thru 2000 FPM (610)	1 1/2"-30" (38-762)
	LifeLine-Fe™	Steel mill work and back-up rolls, continuous caster areas, bar and rod mills.	Strip Output Feed 6000 FPM (1830)	5" - 50" (127-1270)



## SHAFT SEAL REFERENCE - JM CLIPPER

# SPECIAL DESIGN SEALS

INCH SIZE  
SHAFT SEALS



Cross Section	Description
	<p>The Type FL low cost general purpose seal is designed for rotary and reciprocating service. The all rubber lip element is integrally formed into its sealing position and self gasketed within the closed shell assembly to eliminate inner case leakage. The formed metal contour under the lip provides stability to the lip.</p>
	<p>The SlipTite (Teflon®/Rubber) seal was specifically developed for severe service. It has a single lip element that combines the low friction properties of Teflon with the flexibility and durability of rubber. It is sealed into an outer metal case and engineered for intermittent pressure service up to 10 psi.</p> <p><small>*Registered DuPont trademark</small></p>
	<p>The TMA-L and TMA-S seals are designed specifically for special corrosive chemical service. The Stainless Steel outer case contains a machined Teflon seal insert with or without a spring activated lip.</p>
	<p>The Type HP high pressure seal is a sophisticated design to handle rotary and/or reciprocating motion at high speeds and pressures over a temperature range of (-40°F to +400°F). Pressures up to 300 psi and 4,000 DPM can be handled.</p>
	<p>The Type MP medium pressure seal is designed to handle rotary applications up to 100 psi and temperatures from -40°F to 400°F. The inner metal shell is encapsulated in fluoroelastomer.</p>
	<p>The Clipper SlipTite is a specially designed seal that utilizes a layer of PTFE molded to the sealing lip to reduce excessive wearing on the shaft. It can handle pressure applications up to 40 psi and higher temperatures up to 350°F. The Clipper SlipTite can be utilized in applications with limited lubrication. LUP, RUP, SS, SSW, HP &amp; MP designs can be produced.</p>
	<p>JM Clipper Extruded seals are available in both single and dual lip types where installation of solid or rigid seals becomes difficult or impossible due to size or location.</p>
	<p>The JM Clipper positive lip contact sheave seal provides excellent foreign matter exclusion properties while retaining bearing lubricant. These seals are used on wire rope sheaves found in overhead cranes in the steel mills; on rotary drilling rig crown and travel blocks; and on draglines, hoists and elevators. They also have application on mine car wheels, flywheels and idler wheels.</p>
6	<p>Other specialty seals can be custom designed to meet your specific equipment requirements.</p>

## SHAFT SEAL REFERENCE - JM CLIPPER

# MATERIAL STYLES

Style	Type of Elastomer	Typical Shore A Hardness	Temperature Range °F (°C)	Relative Price
<b>Outer Heel</b>				
H1	Hard, dense, rugged aramid fiber oil resistant - rubber composition	95+	-65 to +250 (-54 to +177)	Low
H3	Rigid dense - aramid fiber oil resistant - composition	93	-20 to +250 (-28 to +121)	Medium
H5	Hard, dense, special aramid fiber - high temperature rubber composition of Resistan® (special formulation of Fluoroelastomer)	95+	-40 to +400 (-40 to +260)	High
STH1	Style H1 with metal reinforcement in heel, body	95+	65 to +300 (-54 to +149)	Low
<b>Lip Element</b>				
L3	Neoprene Nitrile	55	40 to +200 (-40 to +93)	Medium
L5	Nitrile (replaces Style L10)	77	20 to +250 (-28 to +149)	Low
L7	Nitrile	89	30 to +300 (-14 to +140)	Low
L8	Neoprene Fiber	93	-20 to +250 (-28 to +121)	Medium
L16*	Resistan® (special formulation of fluoroelastomer)	85	-40 to +400 (-40 to +260)	High
L17	Teflon® (Types TMA L and TMA S only)		-300 to +350 (-184 to +177) (+360) +500 intermittent	High
L50	Alaska Nitrile™ (special formulation of Nitrile Elastomer)	85	-50 to +250 (-57 to +121)	Medium
L70	Alaska Nitrile™ (special formulation of Nitrile Elastomer)	75	-70 to +250 (-57 to +121)	Medium

1. Other special application seal materials are available

2. Specialty Materials for use with the F/L and Slip/Lite designs are available for varying service conditions.

\* Registered DuPont trademark

† Style H5/L16 marked with narrow white band on heel/body for identification purposes.

INCH SIZE  
SHAFT SEALS



## SHAFT SEAL REFERENCE - JM CLIPPER

INCH SIZE  
SHAFT SEALS

# WORLD CLASS TECHNOLOGIES AND MANUFACTURING

JM Clipper meets customers' sealing needs with a wide range of new and proven technologies including unique rubber/fiber composites, traditional rubber and textiles, PTFE, and flexible graphite. These materials are all utilized at the company's 305,000 square foot facility in Naengdoches, Texas. For more information about JM Clipper products and services visit our website at [www.jmclipper.com](http://www.jmclipper.com).



Packing Division

### Rotary Shaft Seals

Product  
Bulletin

No. 5208B1-USA

### Rotary Shaft Seals/Oil Seals Now Available Through Packing Division's Global Business Unit

#### Excellent quality and competitively priced!

The quality of our products is excellent and you will be pleased with our competitive prices. Prototype costs are very affordable and our non-reoccurring set up charge (N.R.S.U.C.) for production parts is minimal to nonexistent.

#### The seal of choice for rotating shafts

Rotary Shaft Seals/Oil Seals are one of the most popular dynamic seals in the sealing industry today. Commonly used in a wide variety of pumps and motors, Rotary Shaft Seals are an excellent choice for sealing high speed rotating shafts and low pressure lubricants. Just about anywhere a bearing is used to support a rotating shaft, you will find a Rotating Shaft Seal installed to keep lubricating fluids in the system and contamination out.

#### Parker offers a wide variety of seal styles

There are literally hundreds of different styles. Most are variations of the standard configuration utilizing a rubber sealing lip to lightly contact a rotating shaft and a metal case to press it into a stationary housing. Depending on the application, Rotary Shaft Seals can be supplied with or without a metal spring, a secondary wiping lip or auxiliary devices. The sealing lip can be bonded to a bare metal case or the case can be supplied covered with rubber. Elastomer blends in Nitrile, Silicone, Fluorocarbon, and Polyacrylate are available along with carbon steel or stainless steel metal springs and cases.

#### We can supply the right type of seal

Rotary Shaft Seals can be supplied to the customer's exact design specifications or Parker Packing Division's Global Business Unit can assist you in selecting the appropriate style. To retrofit existing applications Rotary Shaft Seals can be produced based on customer's prints, samples, or by cross-referencing the previous supplier's part number.



#### Quality products from start to finish

Through the Global Business Unit Parker Packing Division supplies its customers with only the highest quality Rotary Shaft Seals. Packing Division Quality Audits ensure production of high quality products from modern, reliable computer controlled equipment. The following steps outline the typical process used to manufacture our Rotary Shaft Seals:

- Detailed product specifications are established utilizing CAD software.
- Tools are manufactured utilizing CAM software and modern CNC equipment.
- Machined cavity molds are inspected, heat-treated and ground precisely to close tolerance specifications.
- Finished tools are inspected by precision instruments.
- Seals are molded using vacuum type hydraulic vulcanization machines.
- Seals are precisely knife trimmed to produce a clean, sharp sealing lip.
- Finished products are inspected at the site of manufacture and again at the Packing Division prior to shipment.

Copyright © 1999, Parker-Hannifin Corporation, Cleveland, OH. All Rights Reserved.

**Build With The Best!**

ISO 9001 Certified

**Parker** Seals

INCH SIZE  
SHAFT SEALS

Tel.: (514) 334-2220  
Fax: (514) 333-8329

**SS 87**

[www.sealsonline.com](http://www.sealsonline.com)



## SHAFT SEAL REFERENCE - PARKER

### Nomenclature

Refer to the nomenclature below to assist you in detailing your Rotary Shaft Seal design specifications.

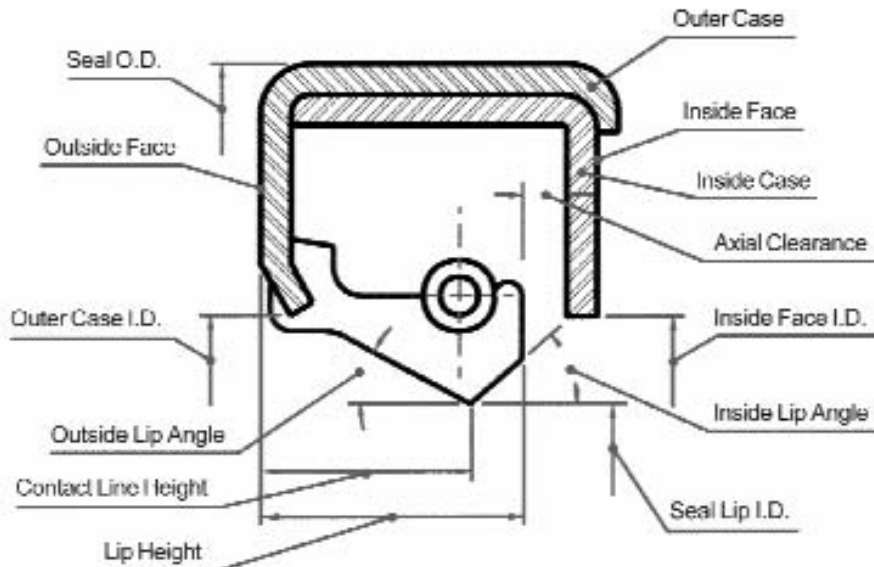
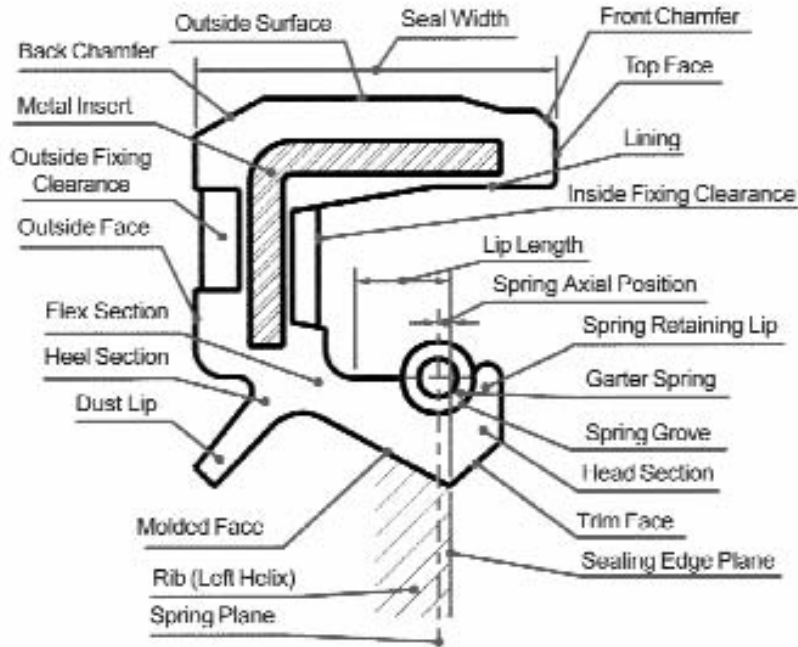

**Warning:** Failure, improper selection or improper use of the products and/or systems described herein or related items can cause death, personal injury or property damage. This document and other information from Parker Hannifin Corporation, its subsidiaries and authorized distributors provide product and/or system options for further investigation by users having technical expertise. It is important that you analyze all aspects of your application and review the information concerning the product or system in the current product catalog. Due to the variety of operating conditions and applications for these products or systems, the user, through his own analysis and testing is solely responsible for making the final selection of the products and systems and assuring that all performance, safety and warning requirements of the application are met.

**Build With The Best!**



**INCH SIZE  
SHAFT SEALS**



## SHAFT SEAL REFERENCE - PIONEER WESTON

INCH SIZE  
SHAFT SEALS

### ① SOLID BODY P.T.F.E SEALS

'Flexibility' is the key word associated with Pioneer Weston's solid bodied P.T.F.E seals, commonly known as R60's.



You name the size, we make the seal, that is as flexible as you can get!

The solid body P.T.F.E lip seal is a two piece construction, consisting of an outer case (solid body) which is machined, not pressed. Also a blended P.T.F.E sealing element which together provide a simple radial lip seal, capable of satisfying a wide range of working conditions.

High temperatures, shaft speeds, pressures, and resistance to chemical attack can be catered for, and because of the simple construction, low volumes, odd sizes, and short delivery times are no problem.



### ② P.T.F.E RANGE OF SEALS



The seal consists of a thin membrane of P.T.F.E, secured between two metal shells and a rubber gasket.

Various hybrid designs of this standard are available to suit the application, including FDA grade material. An important feature of P.T.F.E seals is the uni-directional hydrodynamic pattern which prevents any tendency for leakage, and extends the life of the seal considerably. Low friction, and low heat generation are a vital feature of this seal; which is now being utilised heavily in the automotive, and specialist industrial sectors.

Their emphasis of course being durability, and reliability.



**Pioneer  
Weston**  
SHAFT SEALS

Tel.: (888) 238-5885  
Fax: (888) 238-1664

SS

89

[www.sealsonline.com](http://www.sealsonline.com)



## SHAFT SEAL REFERENCE - PIONEER WESTON

### STANDARD, ROTARY SHAFT SEALS

3



Along with our vast technical experience goes our extensive range of standard rotary shaft seals.

The range is covered by four basic designs, designated, R4, R6, R21 and R23. The R4, is a metal cased single lip seal with a spring assisted lip. The R6 is similar, but with an additional dust lip to prevent the ingress of external dirt, water etc, into the sealed medium.

Both the R21 and R23 seals are 'rubber covered' versions of the R4 and R6 respectively.

This standard range of seals is suitable for use in the majority of medium range applications. Most seals in this range use NBR rubber as standard, but other compounds and variations are available, dependent on the application.



### TX SPLIT SEALS

4

Losing production? Regular weekend working? Downtime costing a fortune in lost man hours?

These questions are simply answered, look no further than Pioneer Weston's split radial lip seal, TX Series.

Cut your replacement time to a minimum, and your downtime to minutes.

This seal performs all the functions of a standard radial lip seal but also

has all the benefits which attract the maintenance and design engineers, the seal components are split.



Costs are kept to a minimum by quick and easy replacement of seal parts, no need to disconnect couplings or remove pulleys and driving keys, simply remove split clamp plates and worn seal, refit new elastomer and clamp plates.



**Pioneer  
Weston**  
SHAFT SEALS

## SHAFT SEAL REFERENCE - PIONEER WESTON

INCH SIZE  
SHAFT SEALS

### 5 AXLE SEAL RANGE



Trucks, Trailers, Tractors...

All these have one thing in common Pioneer Weston supply a wide and varied selection of AXLE Seals to these industries.

Most of the designs are of the unitised type, which means they incorporate a built-in running surface which eliminates a costly shaft surface finishing operation for the customer. All the seals in this range are available in a variety of rubber compounds, materials, and styles to suit your application needs, and our expert design team, and their computer aided skills are always on hand to identify the correct sealing solution.



### IMPAX MECHANICAL SEAL RANGE

6

For many years engineers have been using the mechanical seal principle for solving difficult sealing problems.

Pioneer Weston's vast experience of specific applications, coupled with an energetic development programme has contributed highly to our success in this field. Sound engineering, and a problem solving approach, have made Pioneer Weston the real innovators in mechanical sealing, with an industrial range as diverse as confectionery to coal mining!



The IMPAX balanced pressure seal is specifically designed to meet the need to accommodate high rotational speeds, fluid temperatures and pressures.

The seals are easily stripped into their component form for inspection, and a full spares and refurbishment service is available.



**Pioneer  
Weston**  
SHAFT SEALS

Tel.: (204) 783-9617  
Fax: (204) 783-6091

**SS 91**

[www.sealsonline.com](http://www.sealsonline.com)



## SHAFT SEAL REFERENCE - PIONEER WESTON

INCH SIZE  
SHAFT SEALS

7

### NON STANDARD SEALS AND SOLUTIONS



These are the seals that go beyond the call of duty, seals that are particularly prominent in the more aggressive conditions. Typically found in offroad vehicles, site excavators, and agricultural equipment. Basically the applications that turn designers 'grey' overnight!

The seals are mainly of special purpose design, often using alternative and exotic compounds and materials to suit the application. The emphasis is on the exclusion of external contaminants, such as sand, mud and grits. They are also of use in the food industry where mixing processes often include abrasive ingredients, such as sugar, etc.

The use of designed-in high performance materials gives a high success rate against premature sealing lip failure, and high service costs.

### MOULDED PRODUCTS

8

With over 60 years of rubber moulding and technology experience, we can manufacture a variety of all rubber or bonded rubber products.

Typical items include bushes, plugs, bungs, covers, specialist gaskets, and allied rubber products, etc.

The list is as large as you the customer, wishes it to evolve, we will be more than happy to offer suggested solutions to your particular problem.



**Pioneer  
Weston**  
SHAFT SEALS

## V-RINGS

The V-ring is an axial face seal made of pure elastomer without reinforced fabric or metal. The V-ring is suitable for use as a single seal against dirt, dust, water, grease or oil. The sealing lip slides on a mating surface at right-angles to the shaft. The ring rotates with the shaft. The five different profile types A, E, L, S, and RM are available for the many possible applications. The E and RM types are designed mainly for use in heavy machinery. The RM V-ring has a groove on the outer periphery for accepting a clamping strip.

The sealing lip runs on a mating surface positioned vertically with respect to the shaft. The ring runs together with the shaft.

The V-ring provides a reliable seal when the shaft is both tilted and eccentric to its axis.

Standard materials are nitrile rubber (NBR) resistant to mineral oil-based media and fluorinated rubber for high temperatures and aggressive media. V-rings can also be made of other materials on request.

Application limits		
Pressure	0.3 bar	4.35 PSI
Temperature		
NBR	-40...+100°C	-40...+212°F
FPM	-23...+150°C	-9.4...+302°F

Surface finish		
Surface roughness	$R_a$	$R_t$
Sliding surface	$\geq 2.5 \mu\text{m}$	$\geq 12 \mu\text{m}$

No special machining is required since the V-ring adheres firmly to the shaft.

### TYPE A



The most common style available in the widest range of sizes from 0.110" shaft to 79.530" nitrile and fluoroelastomer. Ideal for conveyor rollers and appliances.

### TYPE L



Very narrow axial cross-section commonly used in pillow blocks to enhance or replace labyrinth seals. Available in nitrile and fluoroelastomer for shaft sizes from 4.134" shaft to 24.800", also available up to 79.724".

### TYPE S

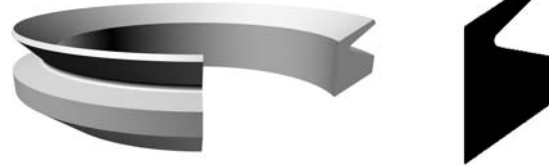

The original V-ring designed with a wide body and tapered heel to firmly hold the ring on the shaft. Available in sizes from 0.180" shaft to 8.270". Commonly use in agricultural and automotive applications.

### TYPE E



The heavy duty large-diameter style commonly used in rolling mills as a dirt/water excluder seal. Available in both nitrile and fluoroelastomer for shaft sizes from 12.000" to 79.130".

### TYPE RM



A heavy duty large-diameter style designed to operate in severe running conditions. The unique body can accommodate radial and axial support in high shaft speed applications. This V-ring can be trimmed to meet existing space requirements, (with a minimum fitted width of 1.670"). Available in sizes from 12.000" shaft to 118.000" in nitrile only. The RM is a made-to-order item.

## V-RINGS - TYPE A

### Type A

Profile and installation dimensions

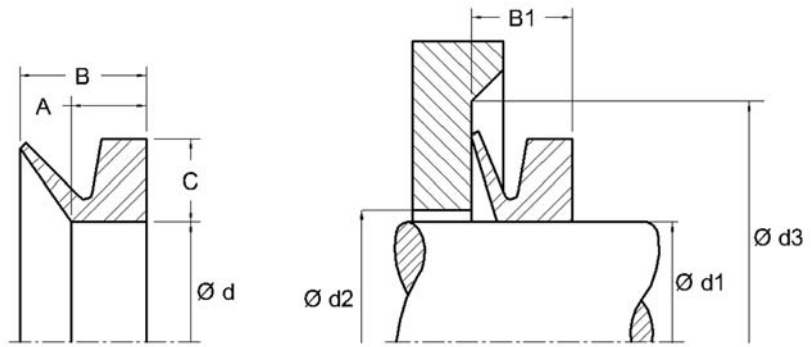

Ref. Number	For shaft diameter		Ød	Section height c	Section width			Diameter		CR Reference (NBR)
	d1 min.	d1 max.			A	B (before installation)	B1 (after installation)	max. d2	min. d3	
V-0003A	0.110 - 0.140	0.100	0.060	0.080	0.120	0.100 +/- 0.012	d1 + 0.040	d1 + 0.160	400030	
V-0004A	0.140 - 0.180	0.130	0.080	0.090	0.150	0.120 +/- 0.016	d1 + 0.040	d1 + 0.240	400040	
V-0005A	0.180 - 0.210	0.160	0.080	0.090	0.150	0.120 +/- 0.016	d1 + 0.040	d1 + 0.240	400050	
V-0006A	0.210 - 0.260	0.200	0.080	0.090	0.150	0.120 +/- 0.016	d1 + 0.040	d1 + 0.240	400060	
V-0007A	0.260 - 0.310	0.240	0.080	0.090	0.150	0.120 +/- 0.016	d1 + 0.040	d1 + 0.240	400070	
V-0008A	0.310 - 0.370	0.280	0.080	0.090	0.150	0.120 +/- 0.016	d1 + 0.040	d1 + 0.240	400080	
V-0010A	0.370 - 0.450	0.350	0.120	0.130	0.220	0.180 +/- 0.020	d1 + 0.080	d1 + 0.350	400100	
V-0012A	0.450 - 0.530	0.410	0.120	0.130	0.220	0.180 +/- 0.020	d1 + 0.080	d1 + 0.350	400120	
V-0013A	0.490 - 0.570	0.450	0.120	0.130	0.220	0.180 +/- 0.020	d1 + 0.080	d1 + 0.350	400130	
V-0014A	0.530 - 0.610	0.490	0.120	0.130	0.220	0.180 +/- 0.020	d1 + 0.080	d1 + 0.350	400140	
V-0016A	0.610 - 0.690	0.550	0.120	0.130	0.220	0.180 +/- 0.020	d1 + 0.080	d1 + 0.350	400160	
V-0018A	0.690 - 0.750	0.630	0.120	0.130	0.220	0.180 +/- 0.020	d1 + 0.080	d1 + 0.350	400180	
V-0020A	0.750 - 0.830	0.710	0.160	0.190	0.300	0.240 +/- 0.030	d1 + 0.080	d1 + 0.470	400200	
V-0022A	0.830 - 0.950	0.790	0.160	0.190	0.300	0.240 +/- 0.030	d1 + 0.080	d1 + 0.470	400220	
V-0025A	0.950 - 1.070	0.870	0.160	0.190	0.300	0.240 +/- 0.030	d1 + 0.080	d1 + 0.470	400250	
V-0028A	1.070 - 1.140	0.980	0.160	0.190	0.300	0.240 +/- 0.030	d1 + 0.120	d1 + 0.470	400280	
V-0030A	1.140 - 1.220	1.060	0.160	0.190	0.300	0.240 +/- 0.030	d1 + 0.120	d1 + 0.470	400300	
V-0032A	1.220 - 1.300	1.140	0.160	0.190	0.300	0.240 +/- 0.030	d1 + 0.120	d1 + 0.470	400320	
V-0035A	1.300 - 1.420	1.220	0.160	0.190	0.300	0.240 +/- 0.030	d1 + 0.120	d1 + 0.470	400350	
V-0038A	1.420 - 1.500	1.340	0.160	0.190	0.300	0.240 +/- 0.030	d1 + 0.120	d1 + 0.470	400380	
V-0040A	1.500 - 1.700	1.420	0.200	0.220	0.350	0.280 +/- 0.040	d1 + 0.120	d1 + 0.590	400400	
V-0045A	1.700 - 1.890	1.570	0.200	0.220	0.350	0.280 +/- 0.040	d1 + 0.120	d1 + 0.590	400450	
V-0050A	1.890 - 2.090	1.770	0.200	0.220	0.350	0.280 +/- 0.040	d1 + 0.120	d1 + 0.590	400500	
V-0055A	2.090 - 2.290	1.930	0.200	0.220	0.350	0.280 +/- 0.040	d1 + 0.120	d1 + 0.590	400550	
V-0060A	2.290 - 2.480	2.130	0.200	0.220	0.350	0.280 +/- 0.040	d1 + 0.120	d1 + 0.590	400600	
V-0065A	2.480 - 2.680	2.280	0.200	0.220	0.350	0.280 +/- 0.040	d1 + 0.120	d1 + 0.590	400650	
V-0070A	2.680 - 2.880	2.480	0.240	0.270	0.430	0.350 +/- 0.050	d1 + 0.160	d1 + 0.710	400700	
V-0075A	2.880 - 3.070	2.640	0.240	0.270	0.430	0.350 +/- 0.050	d1 + 0.160	d1 + 0.710	400750	
V-0080A	3.070 - 3.270	2.830	0.240	0.270	0.430	0.350 +/- 0.050	d1 + 0.160	d1 + 0.710	400800	
V-0085A	3.270 - 3.470	2.990	0.240	0.270	0.430	0.350 +/- 0.050	d1 + 0.160	d1 + 0.710	400850	
V-0090A	3.470 - 3.660	3.190	0.240	0.270	0.430	0.350 +/- 0.050	d1 + 0.160	d1 + 0.710	400900	
V-0095A	3.660 - 3.860	3.350	0.240	0.270	0.430	0.350 +/- 0.050	d1 + 0.160	d1 + 0.710	400950	
V-0100A	3.860 - 4.140	3.540	0.240	0.270	0.430	0.350 +/- 0.050	d1 + 0.160	d1 + 0.710	401000	
V-0110A	4.140 - 4.530	3.900	0.280	0.310	0.500	0.410 +/- 0.060	d1 + 0.160	d1 + 0.830	401100	
V-0120A	4.530 - 4.920	4.250	0.280	0.310	0.500	0.410 +/- 0.060	d1 + 0.160	d1 + 0.830	401200	

N.B.: MINIMUM LINE ORDER MAY APPLY

INCH SIZE  
V-RINGS

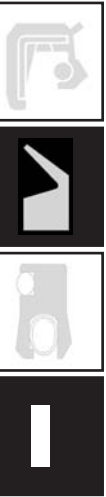

## V-RINGS - TYPE A

INCH SIZE  
V-RINGS

Ref. Number	For shaft diameter		Ød	Section height c	Section width			Diameter		CR Reference (NBR)
	d1				A	B (before installation)	B1 (after installation)	max. d2	min. d3	
	min.	max.								
V-0130A	4.920	5.320	4.610	0.280	0.310	0.500	0.410 +/- 0.060	d1 + 0.160	d1 + 0.830	401300
V-0140A	5.320	5.710	4.960	0.280	0.310	0.500	0.410 +/- 0.060	d1 + 0.160	d1 + 0.830	401400
V-0150A	5.710	6.100	5.310	0.280	0.310	0.500	0.410 +/- 0.060	d1 + 0.160	d1 + 0.830	401500
V-0160A	6.100	6.500	5.670	0.310	0.350	0.570	0.470 +/- 0.070	d1 + 0.200	d1 + 0.940	401600
V-0170A	6.500	6.890	6.020	0.310	0.350	0.570	0.470 +/- 0.070	d1 + 0.200	d1 + 0.940	401700
V-0180A	6.890	7.290	6.380	0.310	0.350	0.570	0.470 +/- 0.070	d1 + 0.200	d1 + 0.940	401800
V-0190A	7.290	7.680	6.730	0.310	0.350	0.570	0.470 +/- 0.070	d1 + 0.200	d1 + 0.940	401900
V-0199A	7.680	8.270	7.090	0.310	0.350	0.570	0.470 +/- 0.070	d1 + 0.200	d1 + 0.940	401990
V-0200A	7.480	8.270	7.090	0.590	0.560	0.980	0.790 +/- 0.160	d1 + 0.400	d1 + 1.770	402000
V-0220A	8.270	9.250	7.800	0.590	0.560	0.980	0.790 +/- 0.160	d1 + 0.400	d1 + 1.770	402200
V-0250A	9.250	10.430	8.860	0.590	0.560	0.980	0.790 +/- 0.160	d1 + 0.400	d1 + 1.770	402500
V-0275A	10.430	11.420	9.720	0.590	0.560	0.980	0.790 +/- 0.160	d1 + 0.400	d1 + 1.770	402750
V-0300A	11.420	12.200	10.630	0.590	0.560	0.980	0.790 +/- 0.160	d1 + 0.400	d1 + 1.770	403000
V-0325A	12.200	13.190	11.500	0.590	0.560	0.980	0.790 +/- 0.160	d1 + 0.400	d1 + 1.770	403250
V-0350A	13.190	14.370	12.400	0.590	0.560	0.980	0.790 +/- 0.160	d1 + 0.400	d1 + 1.770	403500
V-0375A	14.370	15.350	13.270	0.590	0.560	0.980	0.790 +/- 0.160	d1 + 0.400	d1 + 1.770	403750
V-0400A	15.350	16.930	14.170	0.590	0.560	0.980	0.790 +/- 0.160	d1 + 0.400	d1 + 1.770	404000
V-0450A	16.930	18.900	15.940	0.590	0.560	0.980	0.790 +/- 0.160	d1 + 0.400	d1 + 1.770	404500
V-0500A	18.900	20.870	17.720	0.590	0.560	0.980	0.790 +/- 0.160	d1 + 0.400	d1 + 1.770	405000
V-0550A	20.870	22.830	19.490	0.590	0.560	0.980	0.790 +/- 0.160	d1 + 0.400	d1 + 1.770	405500
V-0600A	22.830	24.800	21.260	0.590	0.560	0.980	0.790 +/- 0.160	d1 + 0.400	d1 + 1.770	406000
V-0650A	24.800	26.180	23.620	0.590	0.560	0.980	0.790 +/- 0.160	d1 + 0.400	d1 + 1.770	406500
V-0700A	26.180	27.760	24.800	0.590	0.560	0.980	0.790 +/- 0.160	d1 + 0.400	d1 + 1.770	407000
V-0725A	27.760	29.330	26.380	0.590	0.560	0.980	0.790 +/- 0.160	d1 + 0.400	d1 + 1.770	407250
V-0750A	29.330	30.910	27.760	0.590	0.560	0.980	0.790 +/- 0.160	d1 + 0.400	d1 + 1.770	407500
V-0800A	30.910	32.680	29.330	0.590	0.560	0.980	0.790 +/- 0.160	d1 + 0.400	d1 + 1.770	408000
V-0850A	32.680	34.450	30.910	0.590	0.560	0.980	0.790 +/- 0.160	d1 + 0.400	d1 + 1.770	408500
V-0900A	34.450	36.220	32.480	0.590	0.560	0.980	0.790 +/- 0.160	d1 + 0.400	d1 + 1.770	409000
V-0950A	36.220	37.990	34.060	0.590	0.560	0.980	0.790 +/- 0.160	d1 + 0.400	d1 + 1.770	409500
V-1000A	37.990	39.960	35.830	0.590	0.560	0.980	0.790 +/- 0.160	d1 + 0.400	d1 + 1.770	410000
V-1050A	39.960	41.930	37.600	0.590	0.560	0.980	0.790 +/- 0.160	d1 + 0.400	d1 + 1.770	410500
V-1100A	41.930	43.900	39.370	0.590	0.560	0.980	0.790 +/- 0.160	d1 + 0.400	d1 + 1.770	411000
V-1150A	43.900	45.870	41.140	0.590	0.560	0.980	0.790 +/- 0.160	d1 + 0.400	d1 + 1.770	411500
V-1200A	45.870	47.840	42.910	0.590	0.560	0.980	0.790 +/- 0.160	d1 + 0.400	d1 + 1.770	412000
V-1250A	47.840	50.000	44.690	0.590	0.560	0.980	0.790 +/- 0.160	d1 + 0.400	d1 + 1.770	412500
V-1300A	50.000	51.970	46.460	0.590	0.560	0.980	0.790 +/- 0.160	d1 + 0.400	d1 + 1.770	413000
V-1350A	51.970	53.940	48.230	0.590	0.560	0.980	0.790 +/- 0.160	d1 + 0.400	d1 + 1.770	413500
V-1400A	53.940	55.910	50.000	0.590	0.560	0.980	0.790 +/- 0.160	d1 + 0.400	d1 + 1.770	414000
V-1450A	55.910	57.870	51.770	0.590	0.560	0.980	0.790 +/- 0.160	d1 + 0.400	d1 + 1.770	414500
V-1500A	57.870	59.840	53.540	0.590	0.560	0.980	0.790 +/- 0.160	d1 + 0.400	d1 + 1.770	415000
V-1550A	59.840	61.810	55.320	0.590	0.560	0.980	0.790 +/- 0.160	d1 + 0.400	d1 + 1.770	415500
V-1600A	61.810	63.780	57.090	0.590	0.560	0.980	0.790 +/- 0.160	d1 + 0.400	d1 + 1.770	416000
V-1650A	63.780	65.750	58.860	0.590	0.560	0.980	0.790 +/- 0.160	d1 + 0.400	d1 + 1.770	416500
V-1700A	65.750	67.720	60.630	0.590	0.560	0.980	0.790 +/- 0.160	d1 + 0.400	d1 + 1.770	417000
V-1750A	67.720	69.690	62.400	0.590	0.560	0.980	0.790 +/- 0.160	d1 + 0.400	d1 + 1.770	417500
V-1800A	69.690	71.560	64.170	0.590	0.560	0.980	0.790 +/- 0.160	d1 + 0.400	d1 + 1.770	418000

N.B.: MINIMUM LINE ORDER MAY APPLY

**Tel.: (604) 278-6808**  
**Fax: (604) 278-6180**

**SS 95**

[www.sealsonline.com](http://www.sealsonline.com)





## V-RINGS - TYPE A

Ref. Number	For shaft diameter		Ød	Section height c	Section width			Diameter		CR Reference (NBR)
	d1				A	B (before installation)	B1 (after installation)	max. d2	min. d3	
	min.	max.								
V-1850A	71.650	73.620	65.950	0.590	0.560	0.980	0.790 +/- 0.160	d1 + 0.400	d1 + 1.770	418500
V-1900A	73.620	75.590	67.720	0.590	0.560	0.980	0.790 +/- 0.160	d1 + 0.400	d1 + 1.770	419000
V-1950A	75.590	77.560	69.490	0.590	0.560	0.980	0.790 +/- 0.160	d1 + 0.400	d1 + 1.770	419500
V-2000A	77.560	79.530	71.260	0.590	0.560	0.980	0.790 +/- 0.160	d1 + 0.400	d1 + 1.770	419990
V-2100A	79.530	83.460	72.240	0.590	0.560	0.980	0.790 +/- 0.160	d1 + 0.400	d1 + 1.770	421000
V-2500A	97.358	99.543	86.020	0.590	0.560	0.980	0.790 +/- 0.160	d1 + 0.400	d1 + 1.770	425000

## V-RINGS - TYPE L

### Type L

Profile and installation dimensions

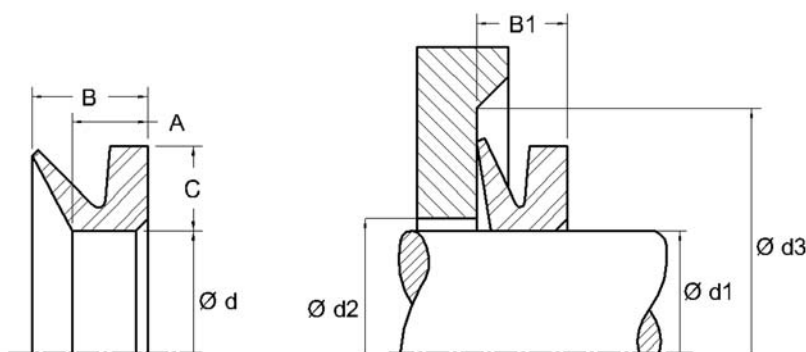

Ref. Number	For shaft diameter		Ød	Section height c	Section width			Diameter		CR Reference (NBR)
	d1				A	B (before installation)	B1 (after installation)	max. d2	min. d3	
	min.	max.								
V-0110L	4.140	4.530	3.900	0.260	0.240	0.410	0.315 +/- 0.060	d1 + 0.200	d1 + 0.800	
V-0120L	4.530	4.920	4.250	0.260	0.240	0.410	0.315 +/- 0.060	d1 + 0.200	d1 + 0.800	
V-0130L	4.920	5.320	4.610	0.260	0.240	0.410	0.315 +/- 0.060	d1 + 0.200	d1 + 0.800	
V-0140L	5.320	5.710	4.960	0.260	0.240	0.410	0.315 +/- 0.060	d1 + 0.200	d1 + 0.800	401402
V-0150L	5.710	6.100	5.310	0.260	0.240	0.410	0.315 +/- 0.060	d1 + 0.200	d1 + 0.800	401502
V-0160L	6.100	6.500	5.670	0.260	0.240	0.410	0.315 +/- 0.060	d1 + 0.200	d1 + 0.800	401602
V-0170L	6.500	6.890	6.020	0.260	0.240	0.410	0.315 +/- 0.060	d1 + 0.200	d1 + 0.800	401702
V-0180L	6.890	7.290	6.380	0.260	0.240	0.410	0.315 +/- 0.060	d1 + 0.200	d1 + 0.800	401802
V-0190L	7.290	7.680	6.730	0.260	0.240	0.410	0.315 +/- 0.060	d1 + 0.200	d1 + 0.800	401902
V-0200L	7.680	8.270	7.170	0.260	0.240	0.410	0.315 +/- 0.060	d1 + 0.200	d1 + 0.800	402002
V-0220L	8.270	9.170	7.800	0.260	0.240	0.410	0.315 +/- 0.060	d1 + 0.200	d1 + 0.800	402202
V-0250L	9.170	10.240	8.860	0.260	0.240	0.410	0.315 +/- 0.060	d1 + 0.200	d1 + 0.800	402502
V-0275L	10.240	11.220	9.720	0.260	0.240	0.410	0.315 +/- 0.060	d1 + 0.200	d1 + 0.800	402752
V-0300L	11.220	12.200	10.630	0.260	0.240	0.410	0.315 +/- 0.060	d1 + 0.200	d1 + 0.800	403002
V-0325L	12.200	13.190	11.500	0.260	0.240	0.410	0.315 +/- 0.060	d1 + 0.200	d1 + 0.800	403252
V-0350L	13.190	14.370	12.400	0.260	0.240	0.410	0.315 +/- 0.060	d1 + 0.200	d1 + 0.800	403502
V-0375L	14.370	15.150	13.270	0.260	0.240	0.410	0.315 +/- 0.060	d1 + 0.200	d1 + 0.800	403752
V-0400L	15.150	16.730	14.170	0.260	0.240	0.410	0.315 +/- 0.060	d1 + 0.200	d1 + 0.800	404002
V-0425L	16.142	17.322	15.039	0.260	0.240	0.410	0.315 +/- 0.060	d1 + 0.200	d1 + 0.800	404252
V-0450L	16.730	18.700	15.940	0.260	0.240	0.410	0.315 +/- 0.060	d1 + 0.200	d1 + 0.800	404502
V-0500L	18.900	20.870	17.720	0.260	0.240	0.410	0.315 +/- 0.060	d1 + 0.200	d1 + 0.800	405002

N.B.: MINIMUM LINE ORDER MAY APPLY

## V-RINGS - TYPE L

INCH SIZE  
V-RINGS

Ref. Number	For shaft diameter		Ød	Section height c	Section width			Diameter		CR Reference (NBR)
	min. d1	max. d1			A	B (before installation)	B1 (after installation)	max. d2	min. d3	
V-0525L	20.080	21.260	18.580	0.260	0.240	0.410	0.315 +/- 0.060	d1 + 0.200	d1 + 0.800	405252
V-0550L	20.870	22.830	19.490	0.260	0.240	0.410	0.315 +/- 0.060	d1 + 0.200	d1 + 0.800	405502
V-0600L	22.830	24.800	21.260	0.260	0.240	0.410	0.315 +/- 0.060	d1 + 0.200	d1 + 0.800	406002
V-0650L	24.790	26.180	23.622	0.260	0.240	0.410	0.315 +/- 0.060	d1 + 0.200	d1 + 0.800	
V-0700L	26.180	27.760	24.803	0.260	0.240	0.410	0.315 +/- 0.060	d1 + 0.200	d1 + 0.800	
V-0750L	29.130	30.510	29.528	0.260	0.240	0.410	0.315 +/- 0.060	d1 + 0.200	d1 + 0.800	407502
V-0800L	30.900	32.680	29.330	0.260	0.240	0.410	0.315 +/- 0.060	d1 + 0.200	d1 + 0.800	
V-0850L	32.680	34.450	30.910	0.260	0.240	0.410	0.315 +/- 0.060	d1 + 0.200	d1 + 0.800	
V-0900L	34.450	36.420	32.480	0.260	0.240	0.410	0.315 +/- 0.060	d1 + 0.200	d1 + 0.800	409002
V-1150L	44.290	46.260	41.142	0.260	0.240	0.410	0.315 +/- 0.060	d1 + 0.200	d1 + 0.800	411502
V-1200L	46.260	48.230	42.913	0.260	0.240	0.410	0.315 +/- 0.060	d1 + 0.200	d1 + 0.800	412002
V-1350L	52.160	54.130	48.228	0.260	0.240	0.410	0.315 +/- 0.060	d1 + 0.200	d1 + 0.800	413502

## V-RINGS - TYPE S

### Type S

Profile and installation dimensions

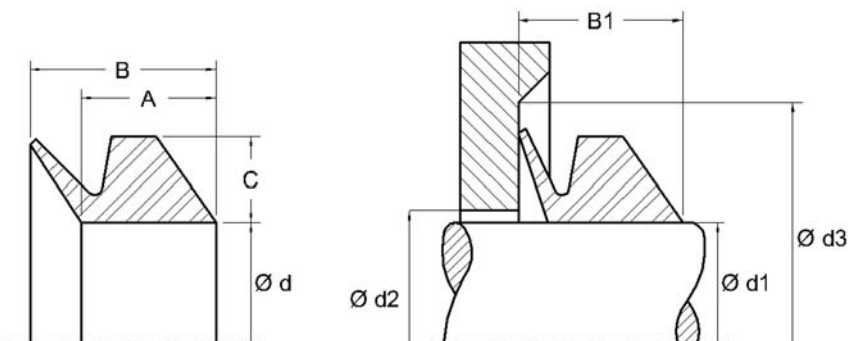

Ref. Number	For shaft diameter		Ød	Section height c	Section width			Diameter		CR Reference (NBR)
	min. d1	max. d1			A	B (before installation)	B1 (after installation)	max. d2	min. d3	
V-0005S	0.180	0.210	0.160	0.080	0.150	0.200	0.180 +/- 0.016	d1 + 0.040	d1 + 0.240	400051
V-0006S	0.210	0.260	0.200	0.080	0.150	0.200	0.180 +/- 0.016	d1 + 0.040	d1 + 0.240	400061
V-0007S	0.260	0.310	0.240	0.080	0.150	0.200	0.180 +/- 0.016	d1 + 0.040	d1 + 0.240	400071
V-0008S	0.310	0.370	0.280	0.080	0.150	0.200	0.180 +/- 0.016	d1 + 0.040	d1 + 0.240	400081
V-0010S	0.370	0.450	0.350	0.120	0.220	0.300	0.260 +/- 0.020	d1 + 0.080	d1 + 0.350	400101
V-0012S	0.450	0.530	0.410	0.120	0.220	0.300	0.260 +/- 0.020	d1 + 0.080	d1 + 0.350	400121
V-0014S	0.530	0.610	0.490	0.120	0.220	0.300	0.260 +/- 0.020	d1 + 0.080	d1 + 0.350	400141
V-0016S	0.610	0.690	0.550	0.120	0.220	0.300	0.260 +/- 0.020	d1 + 0.080	d1 + 0.350	400161
V-0018S	0.690	0.770	0.630	0.120	0.220	0.300	0.260 +/- 0.020	d1 + 0.080	d1 + 0.350	400181
V-0020S	0.770	0.830	0.710	0.160	0.310	0.410	0.350 +/- 0.030	d1 + 0.080	d1 + 0.470	400201
V-0022S	0.830	0.950	0.790	0.160	0.310	0.410	0.350 +/- 0.030	d1 + 0.080	d1 + 0.470	400221
V-0025S	0.950	1.070	0.870	0.160	0.310	0.410	0.350 +/- 0.030	d1 + 0.080	d1 + 0.470	400251
V-0028S	1.070	1.140	0.980	0.160	0.310	0.410	0.350 +/- 0.030	d1 + 0.120	d1 + 0.470	400281
V-0030S	1.140	1.220	1.060	0.160	0.310	0.410	0.350 +/- 0.030	d1 + 0.120	d1 + 0.470	400301
V-0032S	1.220	1.300	1.140	0.160	0.310	0.410	0.350 +/- 0.030	d1 + 0.120	d1 + 0.470	400321

N.B.: MINIMUM LINE ORDER MAY APPLY

Tel.: (418) 688-3202  
Fax: (418) 688-4272

**SS 97**

[www.sealonline.com](http://www.sealonline.com)





## JD PROFILE - FLANGED ROTARY SEAL

### Applications:

- Best choice for sealing rotating shafts, such as pumps, motors and rotary actuators.
- Suitable for pressures to 3000 psi, 21 MPa.

### Features:

- O.D. flange stabilizes seal, prevents seal rotation and resists thermally induced movement.
- Heavy I.D. seal-lip ensures longest life.
- Dual retained spring-energizer for maximum security.
- Low load high-compliance spring energizer.
- Many high-resilience spring-energizer-options, including choice of light, medium and heavy loads (for friction control) and "NACE" corrosion resistance for oil field use.
- Available with silicone-filled cavity for food and drug applications.



INCH SIZE  
SPRING-ENERGIZED  
ROTARY SEALS

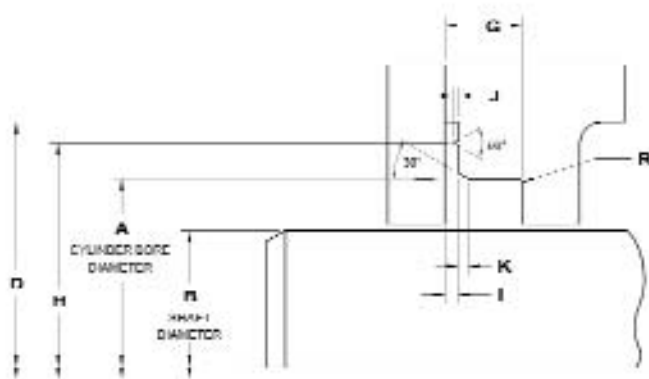
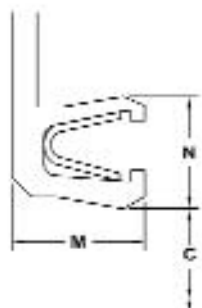

Tel.: (514) 334-2220  
Fax: (514) 333-8329

SS 99

[www.sealsonline.com](http://www.sealsonline.com)



## JD PROFILE - FLANGED ROTARY SEAL

### Cavity Dimensioning

NOMINAL CROSS SECTION	CROSS SECTION CODE	CAVITY				REFERENCE SEAL DIMENSIONS		
		B	A	G	R	C	N	M
		I.D. RANGE Tolerance h8	O.D. Tolerance H8	WIDTH	MAXIMUM RADIUS	I.D.	FREE HEIGHT	WIDTH
1/16 in	01	0.100 - 3.000	B+ 0.112	0.149 - 0.159	0.015	B- 0.01	0.07	0.11
3/32 in	02	0.125 - 7.000	B+ 0.178	0.183 - 0.193	0.025	B- 0.01	0.10	0.15
1/8 in	03	0.250 - 10.000	B+ 0.242	0.235 - 0.245	0.030	B- 0.01	0.14	0.19
3/16 in	04	0.500 - 12.000	B+ 0.372	0.334 - 0.344	0.030	B- 0.02	0.21	0.27
1/4 in	05	2.000 - 20.000	B+ 0.477	0.475 - 0.485	0.030	B- 0.03	0.27	0.37
3/8 in	06	6.000 - 55.000	B+ 0.738	0.622 - 0.632	0.030	B- 0.04	0.41	0.56

### Cross Section

Where space permits, use of the largest cross section seal is preferred. If specifying a diameter which is above the recommended diameter range, use the largest recommended diameter for the appropriate cross section to determine the cavity tolerances.

### Compound selection

Sealing surface	Medium	POLON® PTFE compound
Steel	Hydraulic oils, Mineral oils, Lubrication oils	POLON® 031, 012, 052
Steel chromium plated	Water/oil emulsions, Hot water and steam	POLON® 031, 074
Cast iron	Unlubricated and lubricated air, Fire resistant fluids, Phosphate ester	POLON® 031, 012, 074
Stainless Steel	Unlubricated and lubricated air, Fire resistant fluids, Phosphate ester	POLON® 301,074
Aluminium hard soft	all above listed	POLON® 031 POLON® 044, 067

### Compound specifications

Reference	Compound	Colour	Temp. (°F)		Application	Characteristics
			min.	max.		
POLON® 012	Modified PTFE	dark green	-310	+446	Low-duty hydraulic applications	Improved wear resistance
POLON® 031	PTFE +15% carbon	black	-310	+554	Medium mechanical stress Hard sealing surfaces water/oil emulsions	Chemical resistance limited by carbon
POLON® 044	PTFE +15% graphite	black	-310	+446	Low mechanical stress Soft sealing surfaces	Chemical resistance limited graphite
POLON® 052	PTFE +40% bronze	bronze	-248	+500	Heavy mechanical stress Hydraulic applications	Outstanding wear and creep resistance
POLON® 067	PTFE +10% ekonol	beige	-436	+608	Medium mechanical stress Soft sealing surfaces Rotary sealing	Limited chemical resistance Limited use in hot water
POLON® 074	PTFE +10% carbon fibre	greyish	-436	+590	Water hydraulics Seawater Short strokes with high frequency	Very good wear properties in water

ALSO AVAILABLE

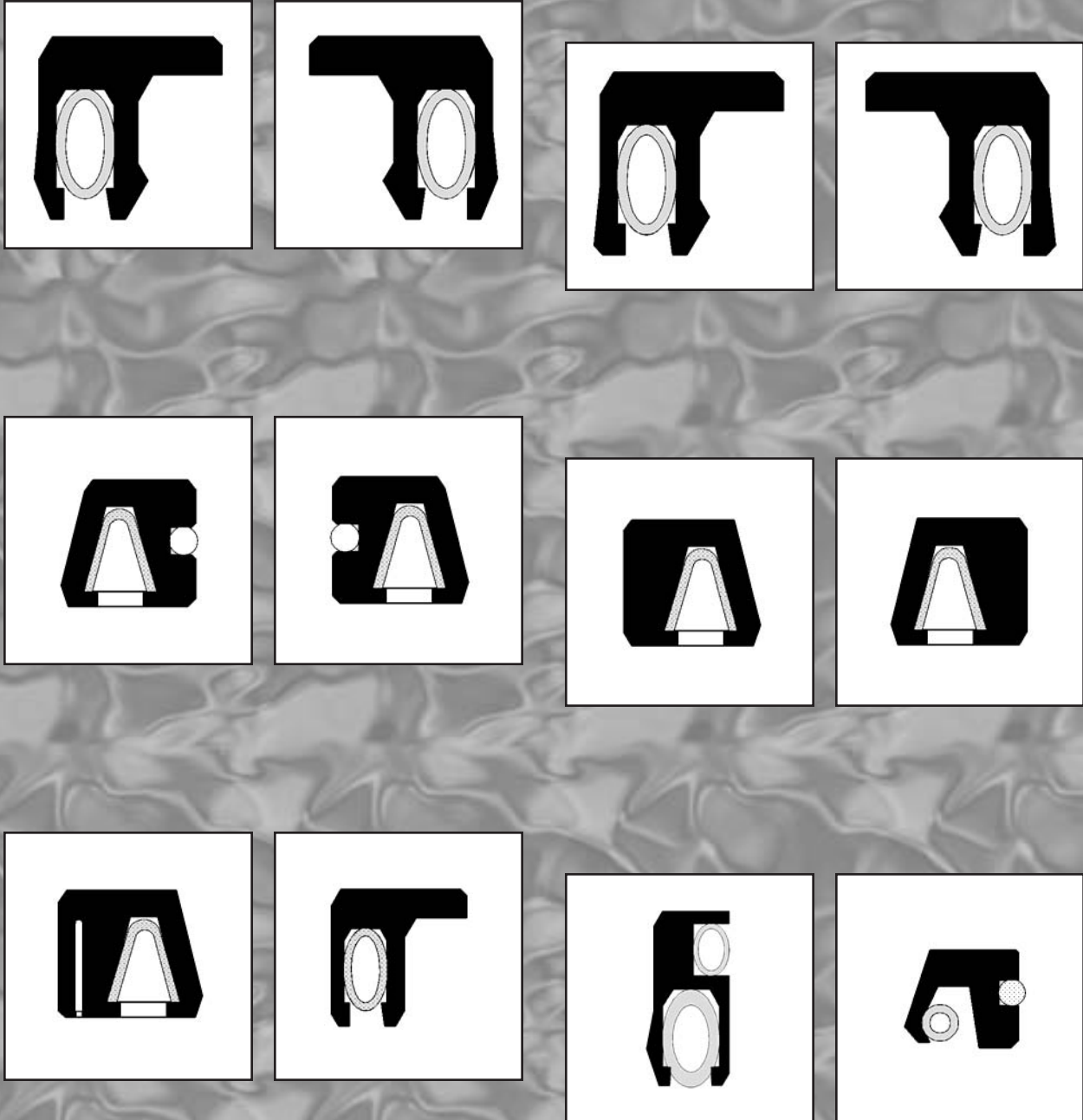

INCH SIZE  
SPRING-ENERGIZED  
ROTARY SEALS



INCH SIZE  
SPRING-ENERGIZED  
ROTARY SEALS

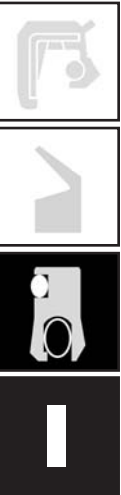

METRIC SIZE  
SHAFT SEALS

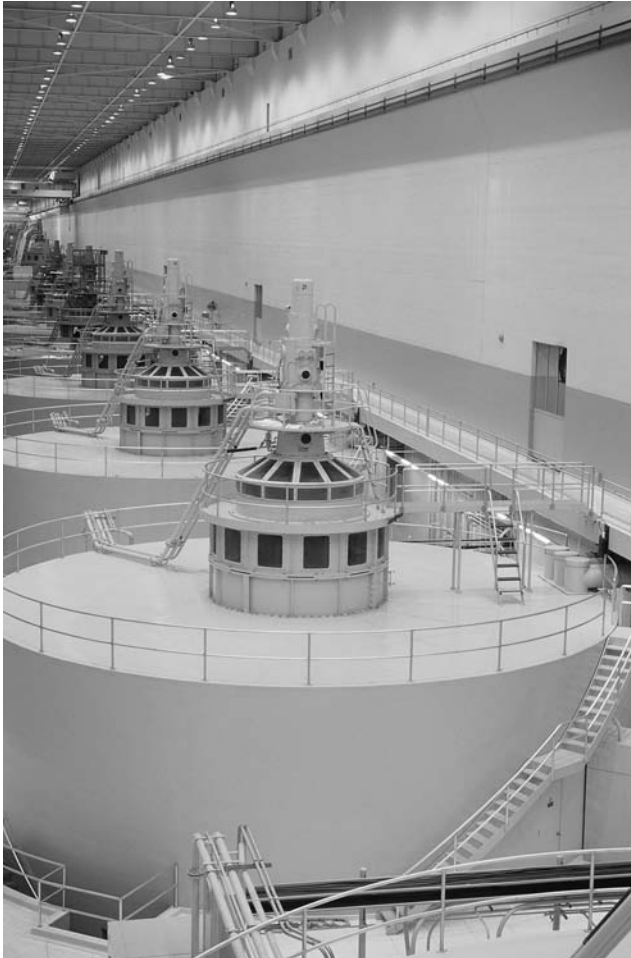

Tel.: (204) 783-9617  
Fax: (204) 783-6091

**SS 103**

[www.sealsonline.com](http://www.sealsonline.com)



## Rotary Shaft seals - types, dimensions, applications DIN3760

The use of rotary shaft seals according to Din 3760, October 1962 edition, which is no longer valid, is to be agreed upon.

Dimensions in millimeters

### 1. Scope

This standard applies to rotary shaft seals for sealing rotating shafts and spaces with negligible differences in pressure (see also section 5.1.2).

### 2. Dimensions and Designation

The shaft seals need not to conform to the illustration: only the specified dimensions must be adhered to.

Type A

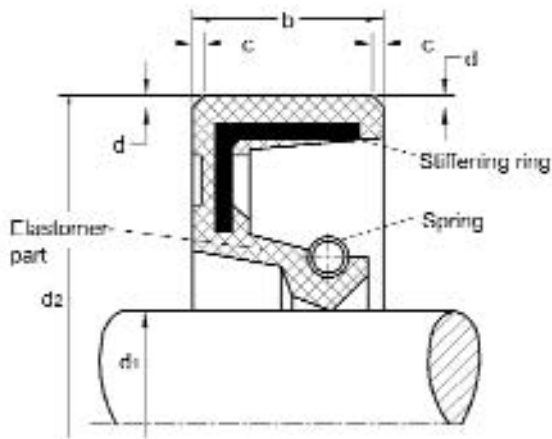

Fig. 1

Type AS

with protective lip, remaining dimensions and details as Type A

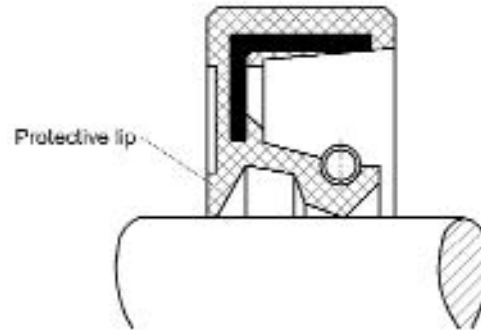

Fig. 2

Designation of a Type A shaft seal (SS) for shaft diameter  $d_1 = 25\text{mm}$ , by  $d_2 = 40\text{mm}$  external diameter and  $b = 7\text{mm}$  breadth, elastomer part made of nitrile butadiene rubber (NB):

Shaft seal	A 25 x 40 x 7 DIN 3760 - NB
or SS	A 25 x 40 x 7 DIN 3750 - NB

If marking with material indicating letters is required (see section 4.2), the letter G is to be appended with a hyphen placed before it.

The extended designation the reads e.g.:

SS	A 25 x 40 x 7 DIN 3760 - NB - G
----	---------------------------------

METRIC SIZE  
SHAFT SEALS



**M**

## Rotary Shaft seals - types, dimensions, applications DIN3760

Table 1

Shaft diameter $d_1$	$d_2^{1)}$	b $\pm 0,2$	$c^{2)}$ min.
6	16	7	0,3
	22		
7	22	7	0,3
8	22	7	0,3
	24		
9	22	7	0,3
	24		
	28		
10	22	7	0,3
	24		
	28		
11	22	7	0,3
	28		
12	22	7	0,3
	24		
	28		
	30		
14	24	7	0,3
	28		
	30		
	38		
15	26	7	0,3
	30		
	32		
	35		
16	28	7	0,3
	30		
	32		
17	30	7	0,3
	32		
	35		
18	30	7	0,3
	32		
	35		
	40		
20	30	7	0,3
	32		
	35		
	40		
22	32	7	0,3
	35		
	40		
	47		
24	35	7	0,3
	37		
	40		
	47		
25	35	7	0,3
	40		
	42		
	47		
26	37	7	0,3
	42		
	47		
28	40	7	0,4
	47		
	52		

Shaft diameter $d_1$	$d_2^{1)}$	b $\pm 0,2$	$c^{2)}$ min.
30	40	7	0,4
	42		
	47		
	52		
	62		
32	45	7	0,4
	47		
	52		
	52		
36	47	7	0,4
	50		
	52		
	62		
	62		
38	52	7	0,4
	55		
	62		
40	52	7	0,4
	55		
	62		
	72		
42	55	8	0,4
	62		
	72		
45	60	8	0,4
	62		
	65		
	72		
48	62	8	0,4
	72		
	72		
50	65	8	0,4
	68		
	72		
52	68	8	0,4
	72		
	72		
55	70	8	0,4
	72		
	80		
	85		
	85		
56	70	8	0,4
	72		
	80		
	85		
58	72	8	0,4
	80		
	80		
60	75	8	0,4
	80		
	85		
	90		
62	85	10	0,5
	90		
	90		
63	85	10	0,5
	90		
	90		
65	85	10	0,5
	90		
	100		
68	90	10	0,5
	90		
	100		

Shaft diameter $d_1$	$d_2^{1)}$	b $\pm 0,2$	$c^{2)}$ min.
70	90	10	0,5
	100		
72	95	10	0,5
	100		
75	95	10	0,5
	100		
78	100	10	0,5
	100		
80	100	10	0,5
	110		

Shaft diameter $d_1$	$d_2^{1)}$	b $\pm 0,3$	$c^{2)}$ min.
85	110	12	0,8
	120		
90	110	12	0,8
	120		
95	120	12	0,8
	125		
100	120	12	0,8
	125		
	130		
105	130	12	0,8
	140		
110	130	12	0,8
	140		
115	140	12	0,8
	150		
120	150	12	0,8
	160		
125	150	12	0,8
	160		
130	160	12	0,8
	170		
135	170	12	0,8
140	170	15	1
145			
150	180	15	1
160			
170	200	15	1
180			
190	220	15	1
200			
210	240	15	1
220			
230	260	15	1
240			
250	280	15	1
260			
280	320	20	1
300			
320	360	20	1
340			
380	400	20	1
380			
400	440	20	1
420			
440	480	20	1
460			
480	520	20	1
500			
500	540	20	1

<sup>1)</sup> See Table 2 for permissible allowance for  $d_2$

<sup>2)</sup> Edges bevelled or rounded as selected by manufacturer

**METRIC SIZE  
SHAFT SEALS**



## Rotary Shaft seals - types, dimensions, applications **DIN3760**

Table 2. Press fit allowance and permissible circularity error of the  $d_2$  external diameter.

external diameter $d_2$	press fit allowance	permissible circularity error
up to 50	+ 0,3 + 0,15	0,25
over 50 to 80	+ 0,35 + 0,2	0,35
over 80 to 120	+ 0,35 + 0,2	0,5
over 120 to 180	+ 0,45 + 0,25	0,65
over 180 to 300	+ 0,45 + 0,25	0,8
over 300 to 500	+ 0,55 + 0,3	1

The  $d_2$  external diameter is to be measured at two points which are offset by 90°; the mean value of both measurements is relevant, whereby the values specified for the permissible circularity error may not be exceeded. Concentricity tolerance according to DIN 7184, sheet 1 (at present still in draft) cannot be used as the SS cannot be included on the reference axis during testing.

### 3. Materials and surface protection

Materials for stiffening ring and spring, as well as surface protection of these parts, is selected by the manufacturer. If sealing is required against media which corrode steel, the question of rust protection for the stiffening ring, as well as the material to be used for the spring must be clarified with the manufacturer.

Material for elastomer part:

Material indicating letters	Elastomer base
NB	Nitrile butadiene rubber
AC	Acrylate rubber
SI	Silicone rubber
FP	Fluoride rubber

The choice of elastomer base suitable for the intended use is determined by the media to be sealed, its permissible constant temperature and the peripheral speed of the shaft (see Table 4 and Fig. 3). In case the application conditions specified in this standard are being exceeded the manufacturer is to be consulted.

### 4. Marking

#### 4.1. Type and size marking

Shaft seals corresponding to the stipulations of this standard, provides sizes permit, are to be permanently marked by: type letters, dimensions, DIN and manufacturer's symbol.

#### 4.2. Marking of elastomer part material

The original packing of shaft seals is always to be marked with the material indicating letter of the elastomer part.

If specially ordered (see section 2) the elastomer part material must be specially marked at a suitable point on the shaft seal.

Following versions of this marking, as selected by the manufacturer. are permissible:

- the material indicating letter for the elastomer part is vulcanized into a surface suitable for this purpose. or
- the elastomer part material is marked with a permanent, mineral oil and grease resistant colour on the rotary shaft seal, or
- given by means of similarly coloured labels.

Following colours apply for b) and c):

for	NB;	white	RAL9002*
	AC:	yellow	RAL1012*
	SI:	blue	RAL5009*
	FP:	red	RAL3000*

### 5. Application

#### Type A rotary shaft seals:

With the elastomer outer covering a close and tight fit in the holding bore hole can be expected in the complete range of temperature, even in the case of materials for housings with greater thermal expansion than steel. Further, damage of the holding bore hole is avoided by the elastomer covering.

#### Type AS rotary shaft seals

Through the protective lip, the AS type has the additional advantage that contaminations are kept away from the actual point sealed. If the space between the sealing lip and protective lip is packed with a suitable grease, wear on the sealing point is reduced and corrosion of the shaft is delayed. The compatibility of the grease with the elastomer base and media selected must be checked.

#### 5.1. Permissible rotational and peripheral speeds

##### 5.1.1. In the case of pressureless operation

Fig.3 shows which shaft speeds may normally be permitted in the case of pressureless operation related to the elastomer par material (amongst others a good lubricating mineral-oil with good lubrication access for the dispersion of heat).

\*)The RAL colours mentioned can be obtained as individual cards of the RAL 840 HR Colour Index from:  
Beuth-Vertrieb GmbH, Burggrafenstrasse, 1000 Berlin 30 and Friesenplatz 16, 5000 Köln 1

METRIC SIZE  
SHAFT SEALS



## Rotary Shaft seals - types, dimensions, applications DIN3760

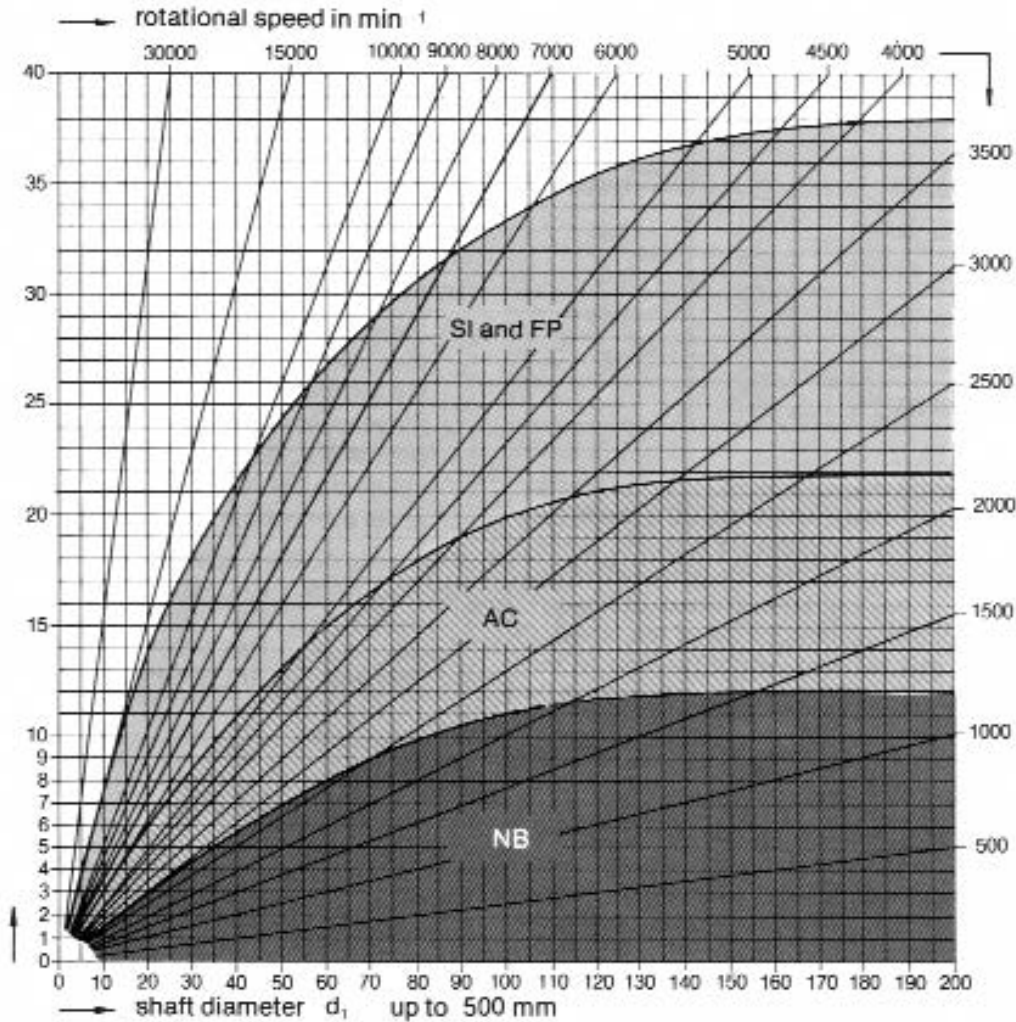

5.1.2. In the case of operating with pressure admission Shaft seals must seal spaces with negligible differences in pressure (see Table 3) against fluids and greases and, as far as lubrication exists, against air. Table 3

pressure difference bar max.	Rotational shaft speed but peripheral speed at the same time	
	min <sup>-1</sup>	m/s max.
0,5	up to 1000	2,8
0,35	up to 2000	3,15
0,2	up to 3000	5,6

In the case of unfavourable sealing conditions, consultation between user and manufacturer is recommended.

5.2. Chemical and thermic durability of the elastomer part (Table 4).

The values shown in table 4 represent a guiding

principle, whereby the media are summarized in groups. The durability of elastomers against media which are not mentioned in table 4 is to be agreed upon between user and manufacturer.

If the constant permissible temperature for a group of media is given, the durability of the elastomer in this range is specified.

A ● means, that there are media within this group of media, which can be sealed by the elastomer concerned, but media are also known, which may impair the elastomer. In this case also, consultation between user and manufacturer is recommended.

A — means, that the elastomer is not resistant against this group of media.

The respective elastomer base is not yet destroyed at the low temperatures specified. the elastomer is fully reusable after rewarming.

METRIC SIZE  
SHAFT SEALS



**M**

Table 4

Material indicating letter	Lowest working temperature (may be permitted as a normal case)	Agents to be sealed												
		Mineral oil based agents							Flame resistant hydraulic fluids (VDMA 24317)			other agents		
	°C	Engine oils	Transmission oils	Hypoid gear oils	AFF oils	Hydraulic oils (see VDMA 24318)	Fuel oils	Greases	Water-oil-emulsions	Hydrous solutions	Waterless fluids	Water	Lyes	Brake fluids
	°C	permissible constant temperature of agent in °C												
NB	-40	100	80	80	100	90	90	90	70	70	—	90	90	—
AC	-30	130	120	120	130	120	●	●	—	●	—	—	—	—
SP <sup>3)</sup>	-50	150	130	—	●	●	●	●	●	●	●	—	—	●
FP	-30	170	150	150	170	150	150	●	●	●	150	100	100	●

## 6. Installation instructions

### 6.1. Generally

In addition to the following instructions, the manufacturer's fitting instructions are to be observed when installing shaft seals. In the case of shaft seals made of silicone elastomer, attention is to be paid to the limited toughness of the sealing lip.

The sealing lips must always face the side to be sealed and it must be guaranteed that they rest freely, i.e. they must not be jammed. Sealing lip contact surfaces must be smooth (see section 6.2.1.) and may not be damaged. Shaft seals must be installed centrally and vertically to the shaft; the use of a suitable mounting tool is recommended. Shaft

seals may not be distorted in axial direction and also not be used for the transmission of forces.

### 6.2. Shaft

The ISO tolerance-zone h 11 is to be stipulated for the  $d_1$  shaft diameter in the area of the contact surface (see Figs. 5 and 6).

The sealing lip must not be damaged during installation. The following is therefore recommended in the case of:

- installation in direction of shaft Z: rounding off of shaft by 0.6 or 1mm, see Fig. 3 or chamfering of shaft according to Table 5.
- installation in direction of shaft Y: chamfering of shaft according to Table 5.

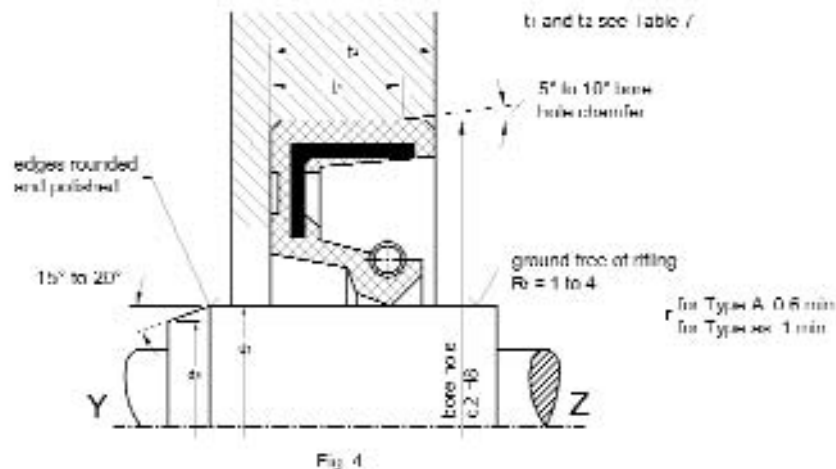

<sup>3)</sup> SI only usable on access of atmospheric oxygen to the point sealed as, otherwise, destruction of the elastomer may occur.

**Table 5. Chamfering on the shaft**

$d_1$ h11	$d_2$	$d_1$ h11	$d_3$	$d_1$ h11	$d_3$	$d_1$ h11	$d_3$	$d_1$ h11	$d_3$	$d_1$ h11	$d_3$
6	4,8	24	21,5	52	48,3	85	80,4	160	153	340	329
7	5,7	25	22,5	55	51,3	90	85,3	170	163	360	349
8	6,6	26	23,4	56	52,3	95	90,1	180	173	380	369
9	7,5	28	25,3	58	54,2	100	95	190	183	400	389
10	8,4	30	27,3	60	56,1	105	99,9	200	193	420	409
11	9,3	32	29,2	62	58,1	110	104,7	210	203	440	429
12	10,2	35	32	63	59,1	115	109,6	220	213	460	449
14	12,1	36	33	65	61	120	114,5	230	223	480	469
15	13,1	38	34,9	68	63,9	125	119,4	240	233	500	489
16	14	40	36,8	70	65,8	130	124,3	250	243	—	—
17	14,9	42	38,7	72	67,7	135	129,2	260	249	—	—
18	15,8	45	41,6	75	70,7	140	133	280	269	—	—
20	17,7	48	44,5	78	73,6	145	138	300	289	—	—
22	19,6	50	46,4	80	75,5	150	143	320	309	—	—

**6.2.1. Surface finish of shaft**

In order to guarantee sealing between seal and shaft, the shaft must be machined to a surface roughness of from 1 to 4  $\mu\text{m}$  in the area of the contact surface. It is essential that this machining does not leave any rifling marks on the shaft which could lead to leakage due to their conveying action.

**6.2.2. Surface hardness of shaft**

The working life of the sealing point is dependent on the surface hardness of the contact surface on the shaft. Minimum hardness should be 45 HRC.

In the case of soiled agents or dirt from outside, as well as peripheral speeds in excess of 4 m/s, the minimum hardness should be 55 HRC.

A minimum hardening depth of 0.3 mm is required for surface hardness. When nitriding is carried out, the grey coating is to be polished.

**6.3. Contact surface**

The values given in sections 6.2.1 and 6.2.2 for surface finish and surface hardening are to be observed

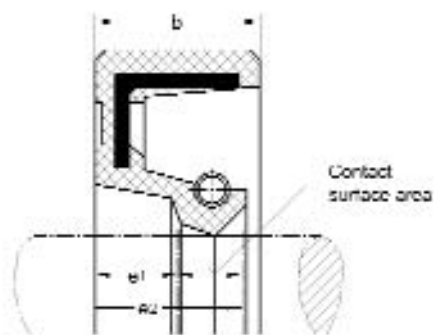

Fig. 5

within the contact surface area quoted in Table 6.

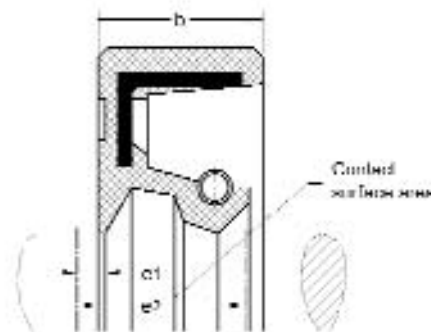

Fig. 6

**Table 6.**

b	contact surface area at			
	sealing lip $e_1$	sealing lip $e_2$ min.	sealing & protective lip $e_3$	sealing & protective lip $e_4$ min.
7	3,5	6,1	1,5	7,6
8	3,5	6,8	1,5	8,3
10	4,5	8,5	2	10,5
12	5	10	2	12
15	6	12	3	15
20	9	16,5	3	19,5

**6.4. Receiving bore hole**

The ISO tolerance-zone h8 is to be stipulated for the  $d_2$  bore hole diameters with a maximum surface roughness of 16mm.

The bore hole is to be chamfered by approx. 5 to 10° according to Table 7. For correlation of b to  $d_2$  see Table 1 and Fig. 4.



## Rotary Shaft seals - types, dimensions, applications **DIN3760**

Table 7.

b	$t_1$ (0,85 · b) min.	$t_2$ (b + 0,3) min.
7	5,95	7,3
8	6,8	8,3
10	8,5	10,3
12	10,3	12,3
15	12,75	15,3
20	17	20,3

### 6.5 Shape and position tolerances

#### 6.5.1. Coaxiality

Figure 7 shows coaxiality tolerances.

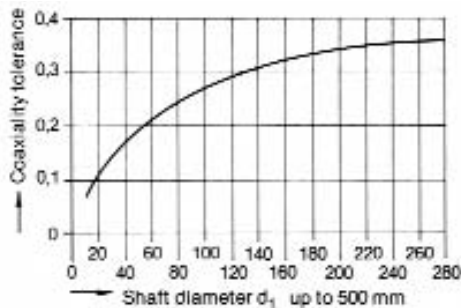

Fig. 7.

#### 6.5.2. Shaft concentricity tolerance

Shaft concentricity tolerance should be kept within narrow limits. This would be necessary because of the existing danger particularly at high speeds, that the sealing edge cannot follow the shaft, due to its inertia. If, due to the concentricity tolerance, the clearance between sealing edges and shaft is larger than is necessary for the maintenance of hydrodynamic lubrication the agent to be sealed escapes from the sealing point. It is, therefore, advisable to locate the shaft seal as close as possible to the bearing and to keep the bearing play as small as possible.

Figure 8 shows shaft concentricity tolerances.

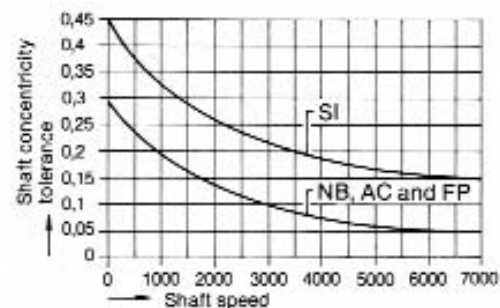

Fig. 8.

### Explanatory notes

When DIN 3760 was published in October 1962, this standard could be regarded as a considerable improvement compared with the DIN Standards 6503 and 6504 which were already out-of-date at that time. In those days three types of construction

- A without metallic casing
- B with metallic casing
- C with metallic casing and cap

had been agreed upon and the breadth «b» fixed as small as possible in the dimension tables to minimize the space requirement. The material specifications were left open and had to be agreed upon when placing the order. A section concerning «application» already gave considerable instructions. In the meantime, the development in the field of rotary shaft seals has continued and sealing against further media's must be additionally undertaken. For this reason, the responsible working committee of the FNA on shaft seals has carried out a revision of seals which is now made public. The following is described:

#### Type of construction

The share of production of the previous construction type C has dropped considerably. This low level has not yet been achieved with construction type B. As these types of construction type A with elastomer, the Working Committee has deleted types B and C. Construction form AS with elastomer outer covering and protective lip has been additionally included, because it has, to an increasing degree, introduced itself into usage. The pro-

ductive lip has been accepted fixed flush with the breadth of the ring. In practice, a grooved surface for the  $d_2$  diameter has become known for the type of construction with elastomer out covering. This version may be pressed into the bore hole much easier and provides less resilience. However, other press fit allowances are necessary than specified in Table 2. This development is yet to be completed and, moreover, it cannot yet be assessed whether the smooth surfaces used so far can be generally replaced by a grooved one. For this reason a stipulation in this standard has been abstained from. As the shaping of the surface area is still open, nothing has been laid down concerning the measuring of the diameter and the contact pressure to be applied upon.

#### Table 1

To prevent false assumptions it has been stated that the  $d_1$  diameters specified refer to the diameter of the shaft.

A rotary shaft seal appropriately dimensioned is selected by the manufacturer. This proves necessary because the dimension of the elastomer sealing element is yet to be laid down and because the manufacturer must select the most favorable contact pressure corresponding to the October 1962 edition. Only 7 x 16, 8 x 16, 10 x 19 and 15 x 24 ring sizes have been omitted because they do not correspond to the ratio of the radial ring height

$$\frac{d_2 - d_1}{2} \geq 5\text{mm}$$



## Rotary Shaft seals - types, dimensions, applications **DIN3760**

### Materials

Taking into account the various media's which are to be sealed, four elastomer bases had to be included. These must be contained in the designation example when ordering. The letters selected indicating the material are supplementary means, only, to indicate the elastomer. It is left to the discretion of the individual manufacturers to select the respective recipe according to his own experience. However, the finished vulcanized shaft seal must satisfy the requirements of this standard.

### Marking

For obvious reasons, it is a consumer requirement that rotary shaft seals are marked: this arises in particular in the case of replacement, because it must be known which shaft seal is suitable. The marking of the material is, however, confronted with difficulties on the part of the manufacturer. To some extent it is customary to vulcanize several elastomer bases in the same mould. For this reason the Working Committee could not agree in principle to marking with letters indicating the material. If marking is required, this must be expressed when ordering.

The selection of letters indicating the material is in conformity with the previous regulations. However, the ISO Recommendation R 1629 which was published in March 1971, contained the following indicating letters:

NBR	in place of	NB
ACM	in place of	AC
MQ	in place of	SI
FPM	in place of	FP

As these new indicating letters have not as yet been taken over into a German basic standard, it was impossible to include them in this standard.

### Application

This section has been rearranged and extended. To start with, it provides information concerning both types of construction, A and AS.

### Figure 3

Figure 3 shows a summary of the peripheral speeds possible in case of specific shaft diameters related to the elastomer base, for the case of pressureless operation.

### Table 3

The previous edition of October 1962 just indicated that shaft seals for sealing rotating shafts are only to be applied in spaces with small differences in pressure (about 0.5 bar). Table 3 in the new edition gives

a more accurate definition, whereby the rational speed of the shaft is referred to in relationship to the peripheral speed.

Table 4. Chemical and thermal durability of the elastomer part

DIN 6503 and DIN 6504 refer to -30°C to +130°C continuous operation. On the other hand the October 1962 edition of DIN 3760 referred to -40°C to +110°C.

These specifications have not been valid for some time now because they must be regarded in relationship to a specific elastomer base. Table 4 and the explanatory preamble thereto now provides information concerning the relations and should be carefully considered in the application so that a maximum working life is achieved. Taking the reciprocal coordination of mechanical, thermal and chemical stresses into account, permanent temperatures higher than those specified in Table 4 may frequently be applied.

### Shaft surface

The sections «Surface Finish of Shaft» and «Surface Hardness of Shaft» show what is to be considered in order to achieve a good sealing action and adequate working life.

The surface finish of the shaft may be achieved by various manufacturing processes. For this reason, this section specifies the requirements, only. The «free of rifling» requirement arises in order to avoid the pumping effect at the sealing point. This surface finish can, for example, be achieved by plain rollers and also by grinding without axial feed of the grinding wheel (recessing process). To avoid the rifling effect the grinding wheels must also be retracted accordingly.

### Contact surface

Originally, the Working Committee tried to stipulate the clearance of the sealing lip up to the contact surface of the rotary shaft seal. As the development of shaft seals has not yet been completed, there are certain differences with the individual manufacturers. For this reason a contact surface area has been specified, within which surface finish and surface hardness must be observed.

### Tolerances in shape and position













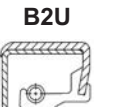
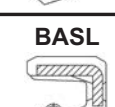



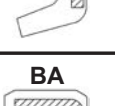

Diagrams have been fitted into the sections «Coaxiality» and «Concentricity Tolerance», in order to create a basis concerning the sizes permissible.

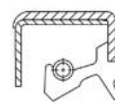
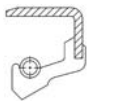

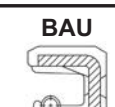
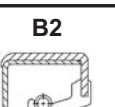

## RADIAL SHAFT SEALS - ALL

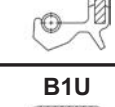
## SIMRIT AVAILABILITY LIST

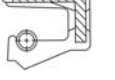











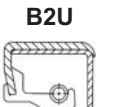
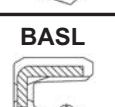

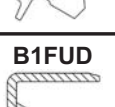

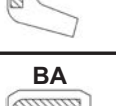

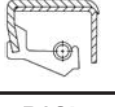
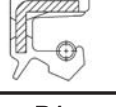
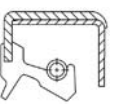

Design Type	Dimensions			Lip Material	Design Type	Dimensions			Lip Material	Diagram	Diagram
	d	D	H			d	D	H			
BAOF	3.00	10.00	6.00	NBR	B1	10.00	16.00	4.00	NBR		
BA	4.00	11.00	6.00	NBR	B10F	10.00	16.00	4.00	NBR		
BA	4.00	12.00	6.00	NBR	BAFUDX7	10.00	16.00	4.00	NBR		
BA	4.00	16.00	7.00	NBR	BAFUDX7	10.00	18.00	4.00	NBR		
BAFUDX7	5.00	15.00	6.00	NBR	BAFUDX7	10.00	18.00	6.00	NBR		
B1U	5.00	16.00	7.00	NBR	B1FUD	10.00	19.00	7.00	NBR		
BA	5.00	19.00	5.00	NBR	BAFUDX7	10.00	19.00	7.00	NBR		
BA	5.00	22.00	8.00	NBR	BASL	10.00	19.00	7.00	NBR		
BA	6.00	16.00	5.00	NBR	BAUMX7	10.00	19.00	7.00	FPM		
BAUMX7	6.00	16.00	6.00	FPM	B1U	10.00	22.00	7.00	NBR		
BA	6.00	16.00	7.00	NBR	BAFUDX7	10.00	22.00	7.00	NBR		
BAU	6.00	19.00	6.00	NBR	BAUMX7	10.00	22.00	7.00	FPM		
BAFUDSLX7	6.00	22.00	7.00	NBR	B2U	10.00	22.00	8.00	NBR		
BAFUDX7	6.00	22.00	7.00	NBR	BA	10.00	22.00	8.00	NBR		
BAUMX7	6.00	22.00	7.00	FPM	BASL	10.00	22.00	8.00	NBR		
BA	6.00	22.00	8.00	NBR	B1	10.00	24.00	7.00	NBR		
B1	7.00	16.00	7.00	NBR	BA	10.00	24.00	7.00	NBR		
BA	7.00	16.00	7.00	NBR	BAUMX7	10.00	24.00	7.00	FPM		
BA	7.00	22.00	6.00	NBR	BAUMSLX7	10.00	26.00	5.00	FPM		
BA	7.00	22.00	7.00	NBR	B1U	10.00	26.00	7.00	NBR		
BAUMX7	7.00	22.00	7.00	FPM	BA	10.00	26.00	7.00	NBR		
B10F	8.00	14.00	6.00	NBR	BASL	10.00	26.00	7.00	NBR		
B1	8.00	16.00	7.00	NBR	BAUMX7	10.00	26.00	7.00	FPM		
B1FUD	8.00	16.00	7.00	NBR	BAU	10.00	28.00	7.00	NBR		
BA	8.00	16.00	7.00	NBR	B2U	10.00	30.00	10.00	NBR		
BASL	8.00	16.00	7.00	NBR	BA	10.00	30.00	10.00	NBR		
BA	8.00	18.00	5.00	NBR	B1	11.00	17.00	4.00	NBR		
BA	8.00	20.00	8.00	NBR	BAFUDX7	11.00	17.00	4.00	NBR		
BAU	8.00	22.00	6.00	NBR	B1U	11.00	22.00	7.00	NBR		
B1U	8.00	22.00	7.00	NBR	BA	11.00	22.00	7.00	NBR		
BA	8.00	22.00	7.00	NBR	BAUMX7	11.00	22.00	7.00	FPM		
BAUMX7	8.00	22.00	7.00	FPM	BAU	11.00	22.00	8.00	NBR		
BA	8.00	22.00	8.00	NBR	BA	11.00	26.00	7.00	NBR		
BAUMSLX7	8.00	22.00	8.00	FPM	BAUMSLX7	11.00	26.00	7.00	FPM		
B1	8.00	24.00	7.00	NBR	BAUMX7	11.00	26.00	7.00	FPM		
BA	8.00	24.00	7.00	NBR	B1SL	12.00	18.00	4.50	NBR		
BAUMX7	8.00	24.00	7.00	FPM	B1SL	12.00	18.00	4.50	NBR		
B1	8.00	28.00	7.00	NBR	B10F	12.00	18.00	5.50	NBR		
B1	9.00	17.00	4.50	NBR	B1	12.00	20.00	5.00	NBR		
BA	9.00	18.00	6.00	NBR	BAUMX7	12.00	20.00	6.00	FPM		
BA	9.00	18.00	7.00	NBR	BAFUDX7	12.00	20.00	7.00	NBR		
B1U	9.00	19.00	5.00	NBR	BA	12.00	22.00	4.00	NBR		
B1U	9.00	22.00	7.00	NBR	BA	12.00	22.00	4.00	NBR		
BA	9.00	22.00	7.00	NBR	BA	12.00	22.00	6.50	NBR		
BAU	9.00	24.00	7.00	NBR	B1	12.00	22.00	7.00	NBR		
BA	9.00	26.00	7.00	NBR	BAU	12.00	22.00	7.00	NBR		
BAU	9.50	25.40	8.00	NBR	BAUMSLX7	12.00	22.00	7.00	FPM		
B10F	10.00	15.00	3.00	NBR	BAUMX7	12.00	22.00	7.00	FPM		

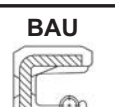
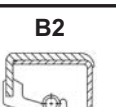
N.B.: MINIMUM LINE ORDER MAY APPLY

## SIMRIT AVAILABILITY LIST

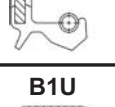
## RADIAL SHAFT SEALS - ALL

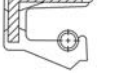
**METRIC SIZE  
SHAFT SEALS**

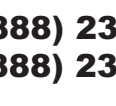
Design Type	Dimensions	Lip Material	Design Type	Dimensions	Lip Material						
						d	D	H	d	D	H
		B2	12.00	22.00	8.00	NBR	BAFUDX7	14.00	28.00	7.00	NBR
		BAUMX7	12.00	24.00	6.00	FPM	BASL	14.00	28.00	7.00	NBR
		BA	12.00	24.00	6.50	NBR	BAUMSLX7	14.00	28.00	7.00	FPM
		B1	12.00	24.00	7.00	NBR	B1	14.00	30.00	7.00	NBR
		BA	12.00	24.00	7.00	NBR	BAU	14.00	30.00	7.00	NBR
		BAUMX7	12.00	24.00	7.00	FPM	BAUMX7	14.00	30.00	7.00	FPM
		BAUMSL	12.00	25.00	5.00	NBR	B2U	14.00	30.00	10.00	NBR
		BAUX2	12.00	25.00	5.00	NBR	BAU	14.00	30.00	10.00	NBR
		BAU	12.00	25.00	8.00	NBR	B1U	14.00	32.00	7.00	NBR
		BAU	12.00	26.00	8.00	NBR	BA	14.00	32.00	10.00	NBR
		B1	12.00	28.00	7.00	NBR	BA	14.00	35.00	7.00	NBR
		BAU	12.00	28.00	7.00	NBR	BA	14.00	35.00	10.00	NBR
		BAUMSLX7	12.00	28.00	7.00	FPM	BA	15.00	24.00	5.00	NBR
		BAUSL	12.00	28.00	7.00	NBR	B1	15.00	24.00	7.00	NBR
		B10F	12.00	30.00	5.00	NBR	B1SL	15.00	24.00	7.00	NBR
		B1	12.00	30.00	7.00	NBR	BA	15.00	24.00	7.00	NBR
		BA	12.00	30.00	7.00	NBR	BAFUDX7	15.00	24.00	7.00	NBR
		BAUMX7	12.00	30.00	7.00	FPM	BAUMX7	15.00	24.00	7.00	FPM
		B2	12.00	30.00	10.00	NBR	BA	15.00	25.00	5.00	NBR
		BA	12.00	30.00	10.00	NBR	B10F	15.00	26.00	4.50	NBR
		B1	12.00	32.00	5.00	NBR	B1	15.00	26.00	7.00	NBR
		B1	12.00	32.00	7.00	NBR	BA	15.00	26.00	7.00	NBR
		BA	12.00	32.00	7.00	NBR	BAUMSLX7	15.00	26.00	7.00	FPM
		B2U	12.00	32.00	10.00	NBR	BAUMX7	15.00	26.00	7.00	FPM
		BA	12.00	32.00	10.00	NBR	BAUSL	15.00	26.00	7.00	NBR
		BAU	12.00	35.00	10.00	NBR	B1FUD	15.00	28.00	7.00	NBR
		BAU	12.70	22.00	6.00	NBR	BAUMX7	15.00	28.00	7.00	FPM
		B1	13.00	20.00	4.00	NBR	BA	15.00	28.00	9.00	NBR
		BAFUDX7	13.00	22.00	4.00	NBR	BAU	15.00	30.00	4.50	NBR
		B1	13.00	22.00	5.00	NBR	B1FUD	15.00	30.00	7.00	NBR
		BA	13.00	25.00	5.00	NBR	BAFUDX7	15.00	30.00	7.00	NBR
		B1U	13.00	26.00	7.00	NBR	BASL	15.00	30.00	7.00	NBR
		BAU	13.00	26.00	7.00	NBR	BAUMX7	15.00	30.00	7.00	FPM
		BASL	13.00	28.00	7.00	NBR	BAU	15.00	30.00	10.00	NBR
		BA	13.00	30.00	8.00	NBR	B1U	15.00	30.00	8.00	NBR
		BA	13.00	30.00	10.00	NBR	B2	15.00	30.00	8.00	NBR
		BAOF	14.00	20.00	5.00	NBR	BASL	15.00	30.00	8.00	NBR
		BA	14.00	22.00	4.00	NBR	B1SL	15.00	30.00	10.00	NBR
		BAU	14.00	23.00	7.00	NBR	B2U	15.00	30.00	10.00	NBR
		B1	14.00	24.00	7.00	NBR	BAU	15.00	30.00	10.00	NBR
		BA	14.00	24.00	7.00	NBR	BAUMX7	15.00	30.00	10.00	FPM
		BAUMSLX7	14.00	24.00	7.00	FPM	B1FUD	15.00	32.00	7.00	NBR
		BAUMX7	14.00	24.00	7.00	FPM	BAFUDX7	15.00	32.00	7.00	NBR
		BA	14.00	25.00	5.00	NBR	BAUMX7	15.00	32.00	7.00	FPM
		B1	14.00	25.00	7.00	NBR	B2	15.00	32.00	10.00	NBR
		B1	14.00	26.00	7.00	NBR	BAU	15.00	32.00	10.00	NBR
		BA	14.00	26.00	7.00	NBR	B1FUDSL	15.00	35.00	7.00	NBR
		B1U	14.00	28.00	7.00	NBR	B1U	15.00	35.00	7.00	NBR

N.B.: MINIMUM LINE ORDER MAY APPLY

Tel.: (888) 238-5885  
Fax: (888) 238-1664













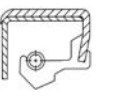



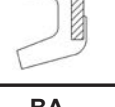

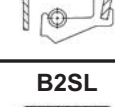
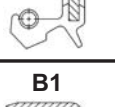
**SS 113**

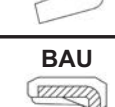
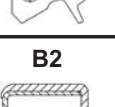
[www.sealsonline.com](http://www.sealsonline.com)

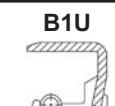

## RADIAL SHAFT SEALS - ALL

## SIMRIT AVAILABILITY LIST













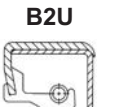
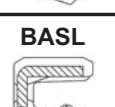

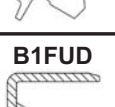

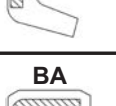
Design Type	Dimensions			Lip Material	Design Type	Dimensions			Lip Material	Diagram	Diagram
	d	D	H			d	D	H			
BAFUDX7	15.00	35.00	7.00	NBR	B2	16.00	35.00	10.00	NBR		
BASL	15.00	35.00	7.00	NBR	BA	16.00	35.00	10.00	NBR		
BAUMSL	15.00	35.00	7.00	FPM	B2	16.00	40.00	10.00	NBR		
BAUMX7	15.00	35.00	7.00	FPM	BAU	16.00	40.00	10.00	NBR		
BAUSL	15.00	35.00	7.00	NBR	BAU	16.00	47.00	7.00	NBR		
BA	15.00	35.00	8.00	NBR	BAFUDX7	17.00	25.00	4.00	NBR		
B1U	15.00	35.00	10.00	NBR	BA	17.00	26.00	6.00	NBR		
B2	15.00	35.00	10.00	NBR	B1	17.00	28.00	6.00	NBR		
BA	15.00	35.00	10.00	NBR	BAFUDX7	17.00	28.00	6.00	NBR		
BASL	15.00	35.00	10.00	NBR	B1FUD	17.00	28.00	7.00	NBR		
B1	15.00	37.00	10.00	NBR	B1USL	17.00	28.00	7.00	NBR		
B2U	15.00	40.00	10.00	NBR	BA	17.00	28.00	7.00	NBR		
BA	15.00	40.00	10.00	NBR	BAFUDSLX7	17.00	28.00	7.00	NBR		
BAU	15.00	42.00	7.00	NBR	BAFUDX7	17.00	28.00	7.00	NBR		
B2	15.00	42.00	10.00	NBR	BASL	17.00	28.00	7.00	NBR		
B2FUD	15.00	42.00	10.00	NBR	BAUMX7	17.00	28.00	7.00	FPM		
BAU	15.00	42.00	10.00	NBR	B1FUD	17.00	30.00	7.00	NBR		
B1OF	16.00	22.00	4.00	NBR	BA	17.00	30.00	7.00	NBR		
B1OF	16.00	24.00	4.00	NBR	BAFUDX7	17.00	30.00	7.00	NBR		
BAFUDX7	16.00	24.00	4.00	NBR	BAUMX7	17.00	30.00	7.00	FPM		
BA	16.00	24.00	5.00	NBR	BAUX2	17.00	30.00	7.00	NBR		
B1	16.00	24.00	6.00	NBR	B1U	17.00	30.00	10.00	NBR		
B1	16.00	24.00	7.00	NBR	B1U	17.00	32.00	7.00	NBR		
B1OF	16.00	24.00	7.00	NBR	BAFUDX7	17.00	32.00	7.00	NBR		
BA	16.00	24.00	7.00	NBR	BASL	17.00	32.00	7.00	NBR		
B1FUD	16.00	28.00	7.00	NBR	BAUMSLX7	17.00	32.00	7.00	FPM		
BAFUDSLX7	16.00	28.00	7.00	NBR	BAUMX7	17.00	32.00	7.00	FPM		
BAFUDX7	16.00	28.00	7.00	NBR	B1U	17.00	32.00	7.50	NBR		
BAUMX7	16.00	28.00	7.00	FPM	B2	17.00	32.00	10.00	NBR		
BAUSL	16.00	28.00	7.00	NBR	BA	17.00	32.00	10.00	NBR		
BAUSL	16.00	28.00	7.00	NBR	BASL	17.00	33.00	9.00	NBR		
B1FUD	16.00	30.00	6.00	NBR	B1	17.00	34.00	4.00	NBR		
B1	16.00	30.00	7.00	NBR	B1FUD	17.00	35.00	7.00	NBR		
BAU	16.00	30.00	7.00	NBR	BAFUDSLX7	17.00	35.00	7.00	NBR		
BAUMX7	16.00	30.00	7.00	FPM	BAFUDX7	17.00	35.00	7.00	NBR		
B1	16.00	30.00	10.00	NBR	BASL	17.00	35.00	7.00	NBR		
B2U	16.00	30.00	10.00	NBR	BAUMSLX7	17.00	35.00	7.00	FPM		
BAU	16.00	30.00	10.00	NBR	B1FUD	17.00	35.00	8.00	NBR		
BAUMSLX7	16.00	30.00	10.00	FPM	B2FUD	17.00	35.00	8.00	NBR		
B1U	16.00	32.00	7.00	NBR	BAU	17.00	35.00	8.00	NBR		
BA	16.00	32.00	7.00	NBR	B1FUD	17.00	35.00	10.00	NBR		
BAUMSLX7	16.00	32.00	7.00	FPM	B2FUD	17.00	35.00	10.00	NBR		
B2U	16.00	32.00	10.00	NBR	BA	17.00	35.00	10.00	NBR		
BAU	16.00	32.00	10.00	NBR	BASL	17.00	35.00	10.00	NBR		
B1	16.00	35.00	7.00	NBR	BA	17.00	37.00	7.00	NBR		
BA	16.00	35.00	7.00	NBR	BASL	17.00	37.00	7.00	NBR		
BAUMSLX7	16.00	35.00	7.00	FPM	B1U	17.00	40.00	7.00	NBR		
B1FUD	16.00	35.00	10.00	NBR	BAFUDX7	17.00	40.00	7.00	NBR		

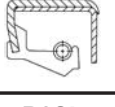
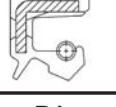
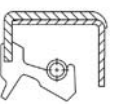
N.B.: MINIMUM LINE ORDER MAY APPLY

## SIMRIT AVAILABILITY LIST

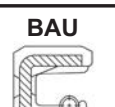
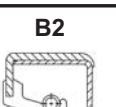
## RADIAL SHAFT SEALS - ALL

**METRIC SIZE  
SHAFT SEALS**

Design Type	Dimensions	Lip Material	Design Type	Dimensions	Lip Material						
						d	D	H	d	D	H
		BAUMX7	17.00	40.00	7.00	FPM	BA	19.00	35.00	10.00	NBR
		BAUX2	17.00	40.00	7.00	NBR	BA	19.00	40.00	10.00	NBR
		B1U	17.00	40.00	10.00	NBR	BA	19.05	31.75	6.35	NBR
		B2	17.00	40.00	10.00	NBR	B2	19.05	38.10	9.50	NBR
		BAU	17.00	40.00	10.00	NBR	B1	20.00	28.00	6.00	NBR
		BAUX2	17.00	47.00	7.00	NBR	BAFUDX7	20.00	28.00	6.00	NBR
		B2	17.00	47.00	10.00	NBR	B1FUD	20.00	30.00	5.00	NBR
		BAU	17.00	47.00	10.00	NBR	BAU	20.00	30.00	5.00	NBR
		BA	17.50	28.00	6.00	NBR	B1FUD	20.00	30.00	7.00	NBR
		B1	18.00	24.00	4.00	NBR	B1FUD	20.00	30.00	7.00	NBR
		BAFUDX7	18.00	28.00	6.50	NBR	B1FUDSL	20.00	30.00	7.00	NBR
		BAFUDX7	18.00	28.00	6.50	NBR	BA	20.00	30.00	7.00	NBR
		B1U	18.00	28.00	7.00	NBR	BAFUDSLX7	20.00	30.00	7.00	NBR
		BAFUDX7	18.00	28.00	7.00	NBR	BAFUDX7	20.00	30.00	7.00	NBR
		BAUMX7	18.00	28.00	7.00	FPM	BAUMX7	20.00	30.00	7.00	FPM
		B1FUD	18.00	30.00	7.00	NBR	BAUMX7	20.00	30.00	7.00	FPM
		B1SL	18.00	30.00	7.00	NBR	BAUX2	20.00	30.00	7.00	NBR
		BA	18.00	30.00	7.00	NBR	B1U	20.00	32.00	7.00	NBR
		BAFUDSLX7	18.00	30.00	7.00	NBR	BAFUDSLX7	20.00	32.00	7.00	NBR
		BAUMX7	18.00	30.00	7.00	FPM	BAFUDX7	20.00	32.00	7.00	NBR
		BA	18.00	30.00	8.00	NBR	BAUMX7	20.00	32.00	7.00	FPM
		B1	18.00	32.00	7.00	NBR	BAU	20.00	33.00	10.00	NBR
		BAU	18.00	32.00	7.00	NBR	BAFUDX7	20.00	35.00	6.00	NBR
		BAUMX7	18.00	32.00	7.00	FPM	B1FUD	20.00	35.00	7.00	NBR
		BASL	18.00	32.00	8.00	NBR	B1SL	20.00	35.00	7.00	NBR
		BAU	18.00	32.00	8.00	NBR	BAFUDSLX7	20.00	35.00	7.00	NBR
		B1U	18.00	35.00	7.00	NBR	BAFUDX7	20.00	35.00	7.00	NBR
		BA	18.00	35.00	7.00	NBR	BAUMX7	20.00	35.00	7.00	FPM
		BAUMSLX7	18.00	35.00	7.00	FPM	BAUSLX2	20.00	35.00	7.00	NBR
		BAUMX7	18.00	35.00	7.00	FPM	BAUX2	20.00	35.00	7.00	NBR
		BAUSLX7	18.00	35.00	7.00	NBR	B1U	20.00	35.00	8.00	NBR
		B1	18.00	35.00	8.00	NBR	BAU	20.00	35.00	8.00	NBR
		B2U	18.00	35.00	8.00	NBR	B1U	20.00	35.00	10.00	NBR
		BA	18.00	35.00	8.00	NBR	B1USL	20.00	35.00	10.00	NBR
		B2	18.00	35.00	10.00	NBR	B2U	20.00	35.00	10.00	NBR
		BA	18.00	35.00	10.00	NBR	BAFUDX7	20.00	35.00	10.00	NBR
		BAUSL	18.00	35.00	10.00	NBR	BASL	20.00	35.00	10.00	NBR
		BA	18.00	37.00	10.00	NBR	BAUSL	20.00	35.00	10.00	NBR
		BA	18.00	40.00	7.00	NBR	B1	20.00	37.00	6.00	NBR
		B2	18.00	40.00	10.00	NBR	B2	20.00	37.00	10.00	NBR
		BA	18.00	40.00	10.00	NBR	BAU	20.00	37.00	10.00	NBR
		B1U	19.00	27.00	6.00	NBR	BA	20.00	38.00	8.00	NBR
		BAU	19.00	27.00	6.00	NBR	B1	20.00	40.00	6.00	NBR
		BAFUDX7	19.00	30.00	7.00	NBR	B1SL	20.00	40.00	7.00	NBR
		B1	19.00	32.00	7.00	NBR	BAFUDX7	20.00	40.00	7.00	NBR
		BA	19.00	32.00	7.00	NBR	BASL	20.00	40.00	7.00	NBR
		BASL	19.00	35.00	9.00	NBR	BAUMX7	20.00	40.00	7.00	FPM
		B2	19.00	35.00	10.00	NBR					

N.B.: MINIMUM LINE ORDER MAY APPLY

**Tel.: (204) 783-9617**  
**Fax: (204) 783-6091**













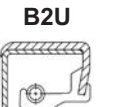
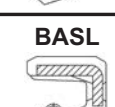



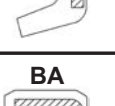

**SS 115**

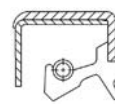
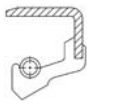
[www.sealsonline.com](http://www.sealsonline.com)

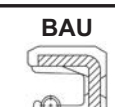
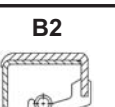

## RADIAL SHAFT SEALS - ALL

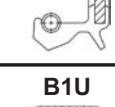
## SIMRIT AVAILABILITY LIST

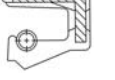
Design Type	Dimensions			Lip Material	Design Type	Dimensions			Lip Material	Diagram	Diagram
	d	D	H			d	D	H			
BAUSL	20.00	40.00	7.00	NBR	BAU	22.00	35.00	10.00	NBR		
B1	20.00	40.00	10.00	NBR	BA	22.00	37.00	7.00	NBR		
B1USL	20.00	40.00	10.00	NBR	BA	22.00	38.00	8.00	NBR		
B2U	20.00	40.00	10.00	NBR	B1	22.00	40.00	7.00	NBR		
BAU	20.00	40.00	10.00	NBR	B1USL	22.00	40.00	7.00	NBR		
B1FUD	20.00	42.00	7.00	NBR	BAFUDSLX7	22.00	40.00	7.00	NBR		
BAFUDX7	20.00	42.00	7.00	NBR	BAFUDX7	22.00	40.00	7.00	NBR		
BASL	20.00	42.00	7.00	NBR	BAUMX7	22.00	40.00	7.00	FPM		
BAUMSLX7	20.00	42.00	7.00	FPM	BAUX2	22.00	40.00	7.00	NBR		
BAUMX7	20.00	42.00	7.00	FPM	BAU	22.00	40.00	8.00	NBR		
B1U	20.00	42.00	10.00	NBR	B1U	22.00	40.00	10.00	NBR		
B2U	20.00	42.00	10.00	NBR	B2U	22.00	40.00	10.00	NBR		
BA	20.00	42.00	10.00	NBR	BAU	22.00	40.00	10.00	NBR		
B1U	20.00	47.00	7.00	NBR	B1	22.00	42.00	10.00	NBR		
BAFUDX7	20.00	47.00	7.00	NBR	B2	22.00	42.00	10.00	NBR		
BASL	20.00	47.00	7.00	NBR	BAU	22.00	42.00	10.00	NBR		
BAUMX7	20.00	47.00	7.00	FPM	BAU	22.00	45.00	7.00	NBR		
B1U	20.00	47.00	10.00	NBR	B1	22.00	47.00	7.00	NBR		
B2	20.00	47.00	10.00	NBR	BAFUDX7	22.00	47.00	7.00	NBR		
BAU	20.00	47.00	10.00	NBR	BAUMSLX7	22.00	47.00	7.00	FPM		
B2	20.00	50.00	12.00	NBR	B2	22.00	47.00	9.00	NBR		
B1U	20.00	52.00	7.00	NBR	B1	22.00	47.00	10.00	NBR		
B2	20.00	52.00	10.00	NBR	B2U	22.00	47.00	10.00	NBR		
BAFUDX7	20.00	52.00	10.00	NBR	BAU	22.00	47.00	10.00	NBR		
BAUMX7	20.00	52.00	10.00	FPM	BAU	23.00	40.00	8.00	NBR		
BAUX2	20.00	52.00	10.00	NBR	B2	23.00	40.00	10.00	NBR		
B1	21.00	30.00	6.50	NBR	BAFUDX7	23.00	40.00	10.00	NBR		
B1	21.00	32.00	7.00	NBR	BAU	23.00	40.00	10.00	NBR		
BAU	21.00	32.00	7.00	NBR	BAU	23.00	42.00	10.00	NBR		
BA	21.00	35.00	8.00	NBR	BA	23.00	47.00	10.00	NBR		
B2U	21.00	35.00	10.00	NBR	B1SL	24.00	32.00	7.00	NBR		
BAU	21.00	40.00	10.00	NBR	B1	24.00	35.00	7.00	NBR		
B1U	22.00	32.00	6.00	NBR	BAFUDX7	24.00	35.00	7.00	NBR		
B1FUD	22.00	32.00	7.00	NBR	BAUMX7	24.00	35.00	7.00	FPM		
BAFUDX7	22.00	32.00	7.00	NBR	B1	24.00	36.00	6.00	NBR		
BASL	22.00	32.00	7.00	NBR	BASL	24.00	36.00	7.00	NBR		
BASL	22.00	32.00	7.00	NBR	BAU	24.00	36.00	9.00	NBR		
BAUMX7	22.00	32.00	7.00	FPM	B1	24.00	37.00	7.00	NBR		
BAU	22.00	33.00	7.00	NBR	BAU	24.00	37.00	7.00	NBR		
BAU	22.00	35.00	6.50	NBR	BAUMX7	24.00	37.00	7.00	FPM		
B1U	22.00	35.00	7.00	NBR	B1U	24.00	40.00	7.00	NBR		
B1USL	22.00	35.00	7.00	NBR	BA	24.00	40.00	7.00	NBR		
BAFUDSLX7	22.00	35.00	7.00	NBR	BAUMSLX7	24.00	40.00	7.00	FPM		
BAFUDX7	22.00	35.00	7.00	NBR	B2U	24.00	40.00	9.00	NBR		
BAUMX7	22.00	35.00	7.00	FPM	B2U	24.00	40.00	10.00	NBR		
BAUMX7	22.00	35.00	7.00	FPM	BAU	24.00	40.00	10.00	NBR		
B1	22.00	35.00	8.00	NBR	B2U	24.00	42.00	10.00	NBR		
BA	22.00	35.00	8.00	NBR	BA	24.00	42.00	10.00	NBR		















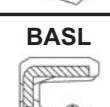

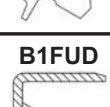

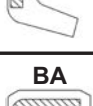

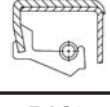
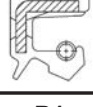
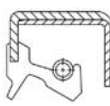

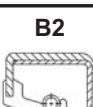

N.B.: MINIMUM LINE ORDER MAY APPLY



## SIMRIT AVAILABILITY LIST

## RADIAL SHAFT SEALS - ALL

**METRIC SIZE  
SHAFT SEALS**

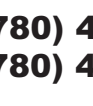
Design Type	Dimensions	Lip Material	Design Type	Dimensions	Lip Material						
						d	D	H	d	D	H
		B1	24.00	47.00	7.00	NBR	BAUX2	25.00	42.00	7.00	NBR
		BA	24.00	47.00	7.00	NBR	B2U	25.00	42.00	9.00	NBR
		B1U	24.00	47.00	10.00	NBR	B1SL	25.00	42.00	10.00	NBR
		B2U	24.00	47.00	10.00	NBR	B1U	25.00	42.00	10.00	NBR
		BAU	24.00	47.00	10.00	NBR	B2U	25.00	42.00	10.00	NBR
		BAU	24.00	50.00	10.00	NBR	BAFUDX7	25.00	42.00	10.00	NBR
		B2U	24.00	52.00	12.00	NBR	B1	25.00	42.90	9.50	NBR
		BAU	24.00	62.00	10.00	NBR	BA	25.00	42.90	9.50	NBR
		B10F	25.00	32.00	5.00	NBR	BAUMX7	25.00	45.00	7.00	FPM
		B1FUDSL	25.00	32.00	7.00	NBR	B1U	25.00	45.00	10.00	NBR
		BAFUDX7	25.00	33.00	6.00	NBR	B2	25.00	45.00	10.00	NBR
		B1FUD	25.00	35.00	7.00	NBR	BA	25.00	45.00	10.00	NBR
		BADUO	25.00	35.00	7.00	NBR	BAUSL	25.00	45.00	10.00	NBR
		BAFUDSLX7	25.00	35.00	7.00	NBR	BADUO	25.00	45.00	14.00	NBR
		BAFUDSLX7	25.00	35.00	7.00	NBR	BAU	25.00	46.00	7.00	NBR
		BAUMX7	25.00	35.00	7.00	FPM	B1FUD	25.00	47.00	7.00	NBR
		BAUSLX2	25.00	35.00	7.00	NBR	B1FUDSL	25.00	47.00	7.00	NBR
		BAU	25.00	35.00	8.00	NBR	BAFUDX7	25.00	47.00	7.00	NBR
		BA	25.00	36.00	7.00	NBR	BAUMSLX7	25.00	47.00	7.00	FPM
		BA	25.00	37.00	5.00	NBR	BAUMX7	25.00	47.00	7.00	FPM
		B1U	25.00	37.00	7.00	NBR	BAUSLX2	25.00	47.00	7.00	NBR
		BAFUDX7	25.00	37.00	7.00	NBR	BAUX2	25.00	47.00	7.00	NBR
		BAU	25.00	37.00	7.00	NBR	B1FUDSL	25.00	47.00	8.00	NBR
		B1	25.00	38.00	7.00	NBR	B2FUD	25.00	47.00	9.00	NBR
		BAU	25.00	38.00	7.00	NBR	B1FUD	25.00	47.00	10.00	NBR
		BAUMX7	25.00	38.00	7.00	FPM	B1FUDSL	25.00	47.00	10.00	NBR
		BAFUDX7	25.00	40.00	5.00	NBR	B2FUD	25.00	47.00	10.00	NBR
		B1	25.00	40.00	6.00	NBR	B2SL	25.00	47.00	10.00	NBR
		B1U	25.00	40.00	7.00	NBR	BAFUDX7	25.00	47.00	10.00	NBR
		BAFUDX7	25.00	40.00	7.00	FPM	BAUMSLX7	25.00	50.00	7.00	FPM
		BAUSL	25.00	40.00	7.00	NBR	B1U	25.00	50.00	10.00	NBR
		B1U	25.00	40.00	8.00	NBR	B2	25.00	50.00	10.00	NBR
		BAUMX7	25.00	40.00	7.00	FPM	BA	25.00	50.00	10.00	NBR
		BAUSL	25.00	40.00	7.00	NBR	B2	25.00	50.00	12.00	NBR
		B1U	25.00	40.00	8.00	NBR	B1FUD	25.00	52.00	7.00	NBR
		BAFUDSLX7	25.00	40.00	8.00	NBR	B1USL	25.00	52.00	7.00	NBR
		BAFUDX7	25.00	40.00	8.00	NBR	BAFUDSLX7	25.00	52.00	7.00	NBR
		B2U	25.00	40.00	9.00	NBR	BAFUDX7	25.00	52.00	7.00	NBR
		BAUSL	25.00	40.00	9.00	NBR	BAUMX7	25.00	52.00	7.00	FPM
		B1U	25.00	40.00	10.00	NBR	B1FUD	25.00	52.00	8.00	NBR
		B2U	25.00	40.00	10.00	NBR	B2FUD	25.00	52.00	9.00	NBR
		BAFUDX7	25.00	40.00	10.00	NBR	B1FUD	25.00	52.00	10.00	NBR
		BA	25.00	42.00	6.00	NBR	B2FUD	25.00	52.00	10.00	NBR
		B1FUD	25.00	42.00	7.00	NBR	BAFUDX7	25.00	52.00	10.00	NBR
		BAFUDX7	25.00	42.00	7.00	NBR	B1FUD	25.00	52.00	12.00	NBR
		BAUMX7	25.00	42.00	7.00	FPM	B1USL	25.00	52.00	12.00	NBR
		BAUSLX2	25.00	42.00	7.00	NBR	B2FUD	25.00	52.00	12.00	NBR
							B1	25.00	62.00	7.00	NBR

N.B.: MINIMUM LINE ORDER MAY APPLY

**Tel.: (780) 414-1871**  
**Fax: (780) 487-5419**

**SS 117**

[www.sealsonline.com](http://www.sealsonline.com)



**M**

## RADIAL SHAFT SEALS - ALL

## SIMRIT AVAILABILITY LIST













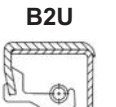
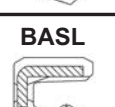

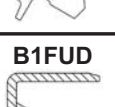

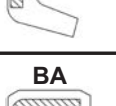

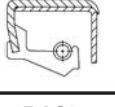
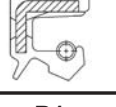
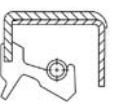



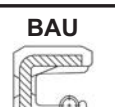
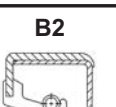



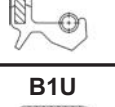

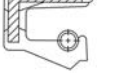
Design Type	Dimensions			Lip Material	Design Type	Dimensions			Lip Material	Diagram	Diagram
	d	D	H			d	D	H			
BAUMX7	25.00	62.00	7.00	FPM	BASL	28.00	40.00	7.00	NBR		
BAUSLX7	25.00	62.00	7.00	NBR	BAUMX7	28.00	40.00	7.00	FPM		
BAFUDX7	25.00	62.00	10.00	NBR	B2	28.00	40.00	7.50	NBR		
B2	25.00	62.00	12.00	NBR	B1U	28.00	40.00	10.00	NBR		
B1FUDSL	25.40	38.00	6.70	NBR	B1	28.00	42.00	7.00	NBR		
B1U	26.00	35.00	7.00	NBR	B1	28.00	42.00	8.00	NBR		
BAFUDSLX7	26.00	35.00	7.00	NBR	BA	28.00	42.00	8.00	NBR		
BAFUDSLX7	26.00	35.00	7.00	NBR	BAUSLX7	28.00	42.00	8.00	NBR		
BAU	26.00	36.00	7.00	NBR	BASL	28.00	42.00	10.00	NBR		
B1	26.00	37.00	7.00	NBR	B1	28.00	42.50	8.00	NBR		
BAU	26.00	37.00	7.00	NBR	BA	28.00	42.50	8.00	NBR		
BAUMSLX7	26.00	37.00	7.00	FPM	B1	28.00	42.90	9.50	NBR		
BAUSL	26.00	37.00	7.00	NBR	BA	28.00	42.90	9.50	NBR		
B1U	26.00	42.00	7.00	NBR	B1U	28.00	45.00	7.50	NBR		
BAFUDSLX7	26.00	42.00	7.00	NBR	BAUMSLX7	28.00	45.00	8.00	FPM		
BAFUDX7	26.00	42.00	7.00	NBR	BA	28.00	47.00	5.00	NBR		
BAUMX7	26.00	42.00	7.00	FPM	B1	28.00	47.00	7.00	NBR		
B2U	26.00	42.00	10.00	NBR	BAFUDX7	28.00	47.00	7.00	NBR		
BA	26.00	42.00	10.00	NBR	BASL	28.00	47.00	7.00	NBR		
BASL	26.00	42.00	10.00	NBR	BAUMX7	28.00	47.00	7.00	FPM		
B1	26.00	45.00	10.00	NBR	B2	28.00	47.00	9.00	NBR		
B1FUD	26.00	45.00	10.00	NBR	B1	28.00	47.00	10.00	NBR		
BAU	26.00	47.00	7.00	NBR	B1SL	28.00	47.00	10.00	NBR		
BAUMX7	26.00	47.00	7.00	FPM	B2	28.00	47.00	10.00	NBR		
B2	26.00	47.00	10.00	NBR	BAU	28.00	47.00	10.00	NBR		
BAU	26.00	47.00	10.00	NBR	B2U	28.00	50.00	10.00	NBR		
BA	26.00	50.00	10.00	NBR	BAU	28.00	50.00	10.00	NBR		
BA	26.00	52.00	8.00	NBR	B2U	28.00	50.00	12.00	NBR		
BAU	26.00	52.00	10.00	NBR	B1U	28.00	52.00	7.00	NBR		
B1U	26.00	52.00	12.00	NBR	BAU	28.00	52.00	7.00	NBR		
BAU	27.00	37.00	7.00	NBR	BAUMX7	28.00	52.00	7.00	FPM		
B2U	27.00	41.00	10.00	NBR	BAUSLX7	28.00	52.00	7.00	NBR		
B2	27.00	42.00	10.00	NBR	B2	28.00	52.00	9.00	NBR		
BAFUDX7	27.00	42.00	10.00	NBR	B2U	28.00	52.00	10.00	NBR		
BA	27.00	47.00	6.00	NBR	BAFUDSLX7	28.00	52.00	10.00	NBR		
BA	27.00	47.00	7.00	NBR	BAU	28.00	52.00	10.00	NBR		
B1	27.00	47.00	10.00	NBR	B2	28.00	52.00	12.00	NBR		
B2	27.00	47.00	10.00	NBR	BA	28.00	55.00	9.00	NBR		
BA	27.00	47.00	10.00	NBR	B2	28.00	62.00	12.00	NBR		
BA	27.00	52.00	8.00	NBR	BAU	28.00	72.00	10.00	NBR		
BA	27.00	52.00	10.00	NBR	BA	29.00	42.90	9.50	NBR		
B10F	28.00	35.00	6.00	NBR	BAU	29.00	43.00	7.00	NBR		
B1U	28.00	38.00	7.00	NBR	B2	29.00	47.00	10.00	NBR		
BAU	28.00	38.00	7.00	NBR	B2	29.00	50.00	10.00	NBR		
BAUMSLX7	28.00	38.00	7.00	FPM	B2	29.00	52.00	10.00	NBR		
B1	28.00	40.00	7.00	NBR	B1FUD	30.00	40.00	7.00	NBR		
BAFUDSLX7	28.00	40.00	7.00	NBR	BAFUDSLX7	30.00	40.00	7.00	NBR		
BAFUDX7	28.00	40.00	7.00	NBR	BAFUDX7	30.00	40.00	7.00	NBR		

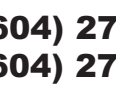
N.B.: MINIMUM LINE ORDER MAY APPLY

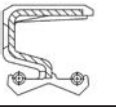
## SIMRIT AVAILABILITY LIST

## RADIAL SHAFT SEALS - ALL

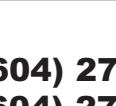
**METRIC SIZE  
SHAFT SEALS**

Design Type	Dimensions	Lip Material	Design Type	Dimensions	Lip Material						
						d	D	H	d	D	H
		BAUMX7	30.00	40.00	7.00	FPM	BA	30.00	48.00	10.00	NBR
		BAUSL	30.00	40.00	7.00	NBR	B1FUD	30.00	50.00	7.00	NBR
		BAFUDSLX7	30.00	40.00	8.00	NBR	BAFUDX7	30.00	50.00	7.00	NBR
		BAU	30.00	40.00	8.00	NBR	BAUMX7	30.00	50.00	7.00	FPM
		BAUSLX2	30.00	42.00	5.50	NBR	BA	30.00	50.00	8.00	NBR
		BAU	30.00	42.00	5.70	NBR	B2FUD	30.00	50.00	9.00	NBR
		BAUX2	30.00	42.00	5.70	NBR	B1FUD	30.00	50.00	10.00	NBR
		B1	30.00	42.00	6.00	NBR	B2FUD	30.00	50.00	10.00	NBR
		B1FUD	30.00	42.00	7.00	NBR	BAFUDSLX7	30.00	50.00	10.00	NBR
		B1FUDSL	30.00	42.00	7.00	NBR	BAU	30.00	50.00	10.00	NBR
		BAFUDSLX7	30.00	42.00	7.00	NBR	B1FUD	30.00	50.00	12.00	NBR
		BAFUDX7	30.00	42.00	7.00	NBR	B1USL	30.00	50.00	12.00	NBR
		BAUMX7	30.00	42.00	7.00	FPM	B2FUD	30.00	50.00	12.00	NBR
		BAFUDSLX7	30.00	42.00	8.00	NBR	B1FUD	30.00	52.00	7.00	NBR
		BAFUDSLX7	30.00	42.00	8.00	NBR	BAFUDSLX7	30.00	52.00	7.00	NBR
		B1U	30.00	44.00	10.00	NBR	BAFUDX7	30.00	52.00	7.00	NBR
		BAFUDSLX7	30.00	44.00	10.00	NBR	BAUMSLX7	30.00	52.00	7.00	FPM
		BAU	30.00	45.00	7.00	NBR	BAUMX7	30.00	52.00	7.00	FPM
		BAUMSLX7	30.00	45.00	7.00	FPM	BAU	30.00	52.00	8.00	NBR
		BAFUDSLX7	30.00	45.00	8.00	NBR	B2FUD	30.00	52.00	9.00	NBR
		BAFUDSLX7	30.00	45.00	8.00	NBR	B2SL	30.00	52.00	9.00	NBR
		BAU	30.00	45.00	8.00	NBR	B1FUD	30.00	52.00	10.00	NBR
		BADUO	30.00	45.00	8.50	NBR	B1FUDSL	30.00	52.00	10.00	NBR
		BAU	30.00	45.00	9.50	NBR	B2FUD	30.00	52.00	10.00	NBR
		BAU	30.00	45.00	10.00	NBR	BA	30.00	52.00	10.00	NBR
		BAUSL	30.00	45.00	13.00	NBR	BAFUDX7	30.00	52.00	10.00	NBR
		BA	30.00	47.00	6.00	NBR	BASL	30.00	52.00	10.00	NBR
		B1U	30.00	47.00	7.00	NBR	B1FUD	30.00	52.00	12.00	NBR
		BAFUDX7	30.00	47.00	7.00	NBR	B1USL	30.00	52.00	12.00	NBR
		BASL	30.00	47.00	7.00	NBR	B2FUD	30.00	52.00	12.00	NBR
		BAUMSLX7	30.00	47.00	7.00	FPM	BA	30.00	52.00	12.00	NBR
		BAUMX7	30.00	47.00	7.00	FPM	BA	30.00	55.00	7.00	NBR
		BAUX2	30.00	47.00	7.00	NBR	BASL	30.00	55.00	7.00	NBR
		B1	30.00	47.00	8.00	NBR	BAUSLX2	30.00	55.00	7.00	NBR
		B1USL	30.00	47.00	8.00	NBR	BAFUDX7	30.00	55.00	10.00	NBR
		B2	30.00	47.00	8.00	NBR	BAUSL	30.00	55.00	10.00	NBR
		BAFUDSLX7	30.00	47.00	8.00	NBR	B1	30.00	55.00	12.00	NBR
		BAU	30.00	47.00	8.00	NBR	B2U	30.00	56.00	10.00	NBR
		BAU	30.00	47.00	9.00	NBR	BAU	30.00	56.00	10.00	NBR
		B1U	30.00	47.00	10.00	NBR	B2	30.00	56.00	12.00	NBR
		B1USL	30.00	47.00	10.00	NBR	BA	30.00	60.00	10.00	NBR
		B2U	30.00	47.00	10.00	NBR	B1U	30.00	62.00	6.00	NBR
		BAFUDX7	30.00	47.00	10.00	NBR	B1FUD	30.00	62.00	7.00	NBR
		BAFUDX7	30.00	47.00	10.00	NBR	B1FUDSL	30.00	62.00	7.00	NBR
		BAFUDX7	30.00	48.00	8.00	NBR	B1SL	30.00	62.00	7.00	NBR
		BAUMSLX7	30.00	48.00	8.00	FPM	BAFUDX7	30.00	62.00	7.00	NBR
		B1	30.00	48.00	10.00	NBR	BASL	30.00	62.00	7.00	NBR
		B2	30.00	48.00	10.00	NBR	BAUMX7	30.00	62.00	7.00	FPM

N.B.: MINIMUM LINE ORDER MAY APPLY

Tel.: (604) 278-6808  
Fax: (604) 278-6180

**SS 119**













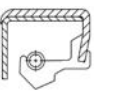

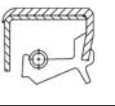
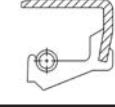

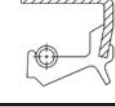
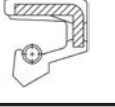
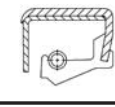

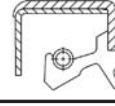
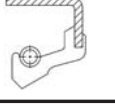

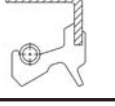
[www.sealsonline.com](http://www.sealsonline.com)

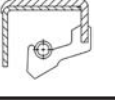
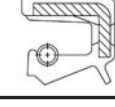
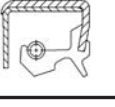

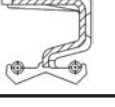

## RADIAL SHAFT SEALS - ALL

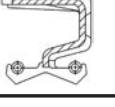
## SIMRIT AVAILABILITY LIST













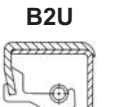
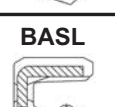

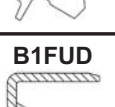

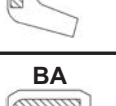
Design Type	Dimensions			Lip Material	Design Type	Dimensions			Lip Material	Diagram	Diagram
	d	D	H			d	D	H			
BAUSL	30.00	62.00	7.00	NBR	BA	32.00	52.00	10.00	NBR		
BAUSLX2	30.00	62.00	7.00	NBR	BAFUDSLX7	32.00	52.00	10.00	NBR		
B2FUD	30.00	62.00	9.00	NBR	B1SL	32.00	52.00	12.00	NBR		
B2FUD	30.00	62.00	10.00	NBR	B2FUD	32.00	52.00	12.00	NBR		
BAFUDX7	30.00	62.00	10.00	NBR	BA	32.00	55.00	10.00	NBR		
B1FUD	30.00	62.00	12.00	NBR	B2	32.00	55.00	12.00	NBR		
B2FUD	30.00	62.00	12.00	NBR	BAU	32.00	56.00	10.00	NBR		
BAU	30.00	62.00	12.00	NBR	BAUSL	32.00	56.00	10.00	NBR		
BADUO	30.00	62.00	14.00	NBR	B2	32.00	56.00	12.00	NBR		
B1U	30.00	72.00	8.00	NBR	BA	32.00	62.00	7.00	NBR		
B2FUD	30.00	72.00	10.00	NBR	B2	32.00	62.00	10.00	NBR		
BAU	30.00	72.00	10.00	NBR	BA	32.00	62.00	10.00	NBR		
BAUMX7	30.00	72.00	10.00	FPM	BAUSLX7	32.00	62.00	10.00	NBR		
B1	32.00	42.00	7.00	NBR	B2	32.00	65.00	12.00	NBR		
BA	32.00	42.00	7.00	NBR	B2	32.00	72.00	12.00	NBR		
BAUMSLX7	32.00	42.00	7.00	FPM	BAU	33.00	45.00	7.00	NBR		
BAUMX7	32.00	42.00	7.00	FPM	BAUSL	33.00	50.00	6.00	NBR		
BA	32.00	45.00	6.00	NBR	BA	33.00	50.00	8.00	NBR		
B1FUD	32.00	45.00	7.00	NBR	B2U	33.00	50.00	10.00	NBR		
BAFUDX7	32.00	45.00	7.00	NBR	BAUSL	33.00	50.00	10.00	NBR		
BASL	32.00	45.00	7.00	NBR	BAFUDX7	33.00	52.00	6.00	NBR		
B1FUD	32.00	47.00	7.00	NBR	B2U	33.00	52.00	10.00	NBR		
BAFUDX7	32.00	47.00	7.00	NBR	BA	33.00	52.00	10.00	NBR		
BAU	32.00	47.00	7.00	NBR	BA	34.00	46.00	8.00	NBR		
BAUMSLX7	32.00	47.00	7.00	FPM	B1	34.00	47.00	9.00	NBR		
BAUMX7	32.00	47.00	7.00	FPM	B1U	34.00	49.30	9.50	NBR		
B1U	32.00	47.00	8.50	NBR	B2U	34.00	50.00	10.00	NBR		
B2U	32.00	47.00	9.00	NBR	BA	34.00	50.00	10.00	NBR		
B1	32.00	47.00	10.00	NBR	B1	34.00	52.00	7.00	NBR		
B1FUDSL	32.00	47.00	10.00	NBR	B1U	34.00	52.00	8.00	NBR		
B2U	32.00	47.00	10.00	NBR	BAU	34.00	52.00	8.00	NBR		
BAU	32.00	47.00	10.00	NBR	B2	34.00	52.00	10.00	NBR		
BA	32.00	48.00	8.00	NBR	B2	34.00	58.00	13.00	NBR		
B1	32.00	50.00	7.00	NBR	BAFUDSLX7	34.00	52.00	10.00	NBR		
BAUMX7	32.00	50.00	7.00	FPM	BAU	34.00	52.00	10.00	NBR		
BAU	32.00	50.00	8.00	NBR	B2	34.00	62.00	10.00	NBR		
B2U	32.00	50.00	10.00	NBR	B2	34.00	72.00	12.00	NBR		
BA	32.00	50.00	10.00	NBR	B1FUD	35.00	45.00	7.00	NBR		
BAUSL	32.00	50.00	10.00	NBR	B1FUDSL	35.00	45.00	7.00	NBR		
B2U	32.00	50.00	12.00	NBR	BA	35.00	45.00	7.00	NBR		
BA	32.00	52.00	5.00	NBR	BAUMX7	35.00	45.00	7.00	FPM		
B1FUD	32.00	52.00	7.00	NBR	BAUSLX2	35.00	47.00	4.50	NBR		
BAFUDX7	32.00	52.00	7.00	NBR	BAUX2	35.00	47.00	4.50	NBR		
BAUMX7	32.00	52.00	7.00	FPM	B1U	35.00	47.00	6.00	NBR		
BAUSL	32.00	52.00	7.00	NBR	B1FUD	35.00	47.00	7.00	NBR		
B2FUD	32.00	52.00	9.00	NBR	B1FUDSL	35.00	47.00	7.00	NBR		
B1FUD	32.00	52.00	10.00	NBR	BAFUDSLX7	35.00	47.00	7.00	NBR		
B2FUD	32.00	52.00	10.00	NBR	BAFUDX7	35.00	47.00	7.00	NBR		

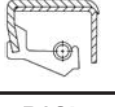
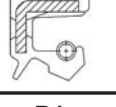
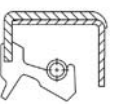
N.B.: MINIMUM LINE ORDER MAY APPLY

## SIMRIT AVAILABILITY LIST

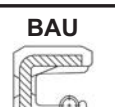
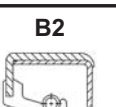
## RADIAL SHAFT SEALS - ALL

**METRIC SIZE  
SHAFT SEALS**

Design Type	Dimensions	Lip Material	Design Type	Dimensions	Lip Material						
						d	D	H	d	D	H
		BASL	35.00	47.00	7.00	NBR	BAFUDX7	35.00	56.00	10.00	NBR
		BAUMSLX7	35.00	47.00	7.00	FPM	BAU	35.00	56.00	10.00	NBR
		BAUMX7	35.00	47.00	7.00	FPM	B1SL	35.00	56.00	12.00	NBR
		BAUSLX2	35.00	47.00	7.00	NBR	B1U	35.00	56.00	12.00	NBR
		BAUX2	35.00	47.00	7.00	NBR	B2U	35.00	56.00	12.00	NBR
		B1U	35.00	47.00	10.00	NBR	BA	35.00	56.00	12.00	NBR
		BAUMSLX7	35.00	48.00	7.00	FPM	BAU	35.00	58.00	10.00	NBR
		B1U	35.00	49.30	9.50	NBR	B2	35.00	58.00	13.00	NBR
		BA	35.00	49.30	9.50	NBR	BA	35.00	58.00	13.00	NBR
		B1FUD	35.00	50.00	7.00	NBR	B1	35.00	60.00	10.00	NBR
		BAFUDX7	35.00	50.00	7.00	NBR	B2	35.00	60.00	10.00	NBR
		BAUMSLX7	35.00	50.00	7.00	FPM	BAFUDX7	35.00	60.00	10.00	NBR
		BAUMX7	35.00	50.00	7.00	FPM	B2	35.00	60.00	12.00	NBR
		BAUSL	35.00	50.00	8.00	NBR	B1	35.00	62.00	5.00	NBR
		B2FUD	35.00	50.00	9.00	NBR	B1FUD	35.00	62.00	7.00	NBR
		B1FUD	35.00	50.00	10.00	NBR	BAFUDX7	35.00	62.00	7.00	NBR
		B1FUDSL	35.00	50.00	10.00	NBR	BASL	35.00	62.00	7.00	NBR
		B2FUD	35.00	50.00	10.00	NBR	BAUMSLX7	35.00	62.00	7.00	FPM
		BAU	35.00	50.00	10.00	NBR	BAUMX7	35.00	62.00	7.00	FPM
		B1SL	35.00	50.00	12.00	NBR	B2FUD	35.00	62.00	9.00	NBR
		B2FUD	35.00	50.00	12.00	NBR	B1FUD	35.00	62.00	10.00	NBR
		B1FUD	35.00	52.00	7.00	NBR	B2FUD	35.00	62.00	10.00	NBR
		BA	35.00	52.00	7.00	NBR	BAFUDX7	35.00	62.00	10.00	NBR
		BAFUDSLX7	35.00	52.00	7.00	NBR	BAUSLX7	35.00	62.00	10.00	NBR
		BAFUDX7	35.00	52.00	7.00	NBR	B1U	35.00	62.00	12.00	NBR
		BAUMX7	35.00	52.00	7.00	FPM	B1USL	35.00	62.00	12.00	NBR
		B2FUD	35.00	52.00	9.00	NBR	B2FUD	35.00	62.00	12.00	NBR
		B2USL	35.00	52.00	9.00	NBR	BASL	35.00	62.00	12.00	NBR
		B1FUD	35.00	52.00	10.00	NBR	BAUSL	35.00	62.00	12.00	NBR
		B2FUD	35.00	52.00	10.00	NBR	BADUO	35.00	62.00	14.00	NBR
		BAFUDSLX7	35.00	52.00	10.00	NBR	B2U	35.00	65.00	10.00	NBR
		BAFUDX7	35.00	52.00	10.00	NBR	BA	35.00	65.00	10.00	NBR
		BAUSL	35.00	52.00	10.00	NBR	BAUSL	35.00	65.00	10.00	NBR
		BAUSLX7	35.00	52.00	10.00	NBR	B2U	35.00	65.00	12.00	NBR
		B1FUD	35.00	52.00	12.00	NBR	B2U	35.00	70.00	12.00	NBR
		B1USL	35.00	52.00	12.00	NBR	BAFUDX7	35.00	72.00	7.00	NBR
		B2FUD	35.00	52.00	12.00	NBR	BAUMX7	35.00	72.00	7.00	FPM
		BAUMSLX7	35.00	55.00	7.00	FPM	BA	35.00	72.00	10.00	NBR
		BAFUDX7	35.00	55.00	8.00	NBR	BASL	35.00	72.00	10.00	NBR
		BAU	35.00	55.00	10.00	NBR	B1FUD	35.00	72.00	12.00	NBR
		BAUSL	35.00	55.00	10.00	NBR	B2FUD	35.00	72.00	12.00	NBR
		BAUSL	35.00	55.00	11.00	NBR	BAFUDX7	35.00	72.00	12.00	NBR
		B1	35.00	55.00	12.00	NBR	BASL	35.00	72.00	12.00	NBR
		B2	35.00	55.00	12.00	NBR	BAFUDSLX7	35.00	80.00	10.00	NBR
		B1U	35.00	55.50	9.00	NBR	B2FUD	35.00	80.00	13.00	NBR
		B1U	35.00	56.00	10.00	NBR	B1	36.00	47.00	7.00	NBR
		B1USL	35.00	56.00	10.00	NBR	BA	36.00	47.00	7.00	NBR
		B2U	35.00	56.00	10.00	NBR	BAUMX7	36.00	47.00	7.00	FPM

N.B.: MINIMUM LINE ORDER MAY APPLY

Tel.: (418) 688-3202  
Fax: (418) 688-4272

**SS 121**

[www.sealsonline.com](http://www.sealsonline.com)



**M**

## RADIAL SHAFT SEALS - ALL

## SIMRIT AVAILABILITY LIST













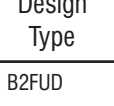

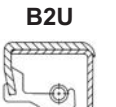

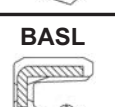

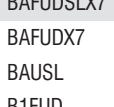
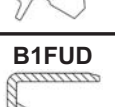



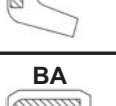
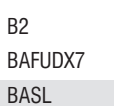

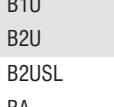
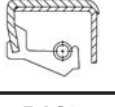
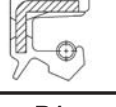

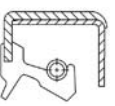

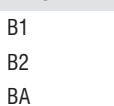

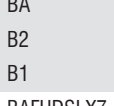
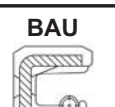
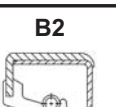



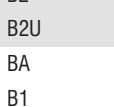

Design Type	Dimensions			Lip Material	Design Type	Dimensions			Lip Material	Diagram	Diagram
	d	D	H			d	D	H			
B1	36.00	50.00	7.00	NBR	B2U	38.00	55.00	9.00	NBR		
BAFUDX7	36.00	50.00	7.00	NBR	B2U	38.00	55.00	10.00	NBR		
BAUMSLX7	36.00	50.00	7.00	FPM	BAU	38.00	55.00	10.00	NBR		
BA	36.00	50.00	10.00	NBR	BAUMSLX7	38.00	55.00	10.00	FPM		
B1U	36.00	52.00	7.00	NBR	B2U	38.00	55.00	12.00	NBR		
BAU	36.00	52.00	7.00	NBR	B2U	38.00	56.00	10.00	NBR		
BAUMX7	36.00	52.00	7.00	FPM	BA	38.00	56.00	10.00	NBR		
B1	36.00	52.00	9.00	NBR	B1	38.00	56.00	12.00	NBR		
B2	36.00	52.00	9.00	NBR	B2	38.00	56.00	12.00	NBR		
BAU	36.00	54.00	7.00	NBR	BA	38.00	58.00	10.00	NBR		
B2	36.00	56.00	10.00	NBR	BAUMX7	38.00	60.00	7.00	FPM		
BAU	36.00	56.00	10.00	NBR	BAU	38.00	60.00	10.00	NBR		
B2	36.00	56.00	12.00	NBR	B1FUD	38.00	62.00	7.00	NBR		
B1	36.00	58.00	10.00	NBR	BAU	38.00	62.00	7.00	NBR		
BA	36.00	62.00	7.00	NBR	BAUMSLX7	38.00	62.00	7.00	FPM		
BAFUDSLX7	36.00	62.00	7.00	NBR	BAUMX7	38.00	62.00	7.00	FPM		
B2	36.00	62.00	9.00	NBR	B2FUD	38.00	62.00	9.00	NBR		
B2	36.00	62.00	10.00	NBR	B2FUD	38.00	62.00	10.00	NBR		
B2	36.00	62.00	12.00	NBR	BAU	38.00	62.00	10.00	NBR		
BAUSLX2	36.00	68.00	10.00	NBR	B1FUD	38.00	62.00	12.00	NBR		
B2	36.00	72.00	12.00	NBR	B2FUD	38.00	62.00	12.00	NBR		
BAU	37.00	52.00	8.00	NBR	BA	38.00	62.00	12.00	NBR		
B2U	37.00	52.00	10.00	NBR	B2	38.00	65.00	10.00	NBR		
B2	37.00	56.00	10.00	NBR	BA	38.00	65.00	10.00	NBR		
B2	37.00	58.00	13.00	NBR	BAUSL	38.00	65.00	10.00	NBR		
B2U	37.00	62.00	9.00	NBR	B2U	38.00	72.00	12.00	NBR		
BA	37.00	62.00	10.00	NBR	BAU	38.00	72.00	12.00	NBR		
B2U	37.00	80.00	13.00	NBR	BAUSL	38.00	74.00	10.00	NBR		
B1U	38.00	50.00	7.00	NBR	BA	38.00	80.00	12.00	NBR		
B1USL	38.00	50.00	7.00	NBR	B2	38.00	80.00	13.00	NBR		
BAFUDX7	38.00	50.00	7.00	NBR	BAUMX7	38.00	90.00	12.00	FPM		
BAUMX7	38.00	50.00	7.00	FPM	B1U	38.10	57.15	9.50	NBR		
B1	38.00	50.00	10.00	NBR	B1	39.00	52.00	6.50	NBR		
B1FUD	38.00	52.00	7.00	NBR	BA	39.00	52.00	6.50	NBR		
B1USL	38.00	52.00	7.00	NBR	B1U	39.00	55.50	9.00	NBR		
BAU	38.00	52.00	7.00	NBR	B2	39.00	62.00	12.00	NBR		
BAUMSLX7	38.00	52.00	7.00	FPM	B1OF	40.00	47.00	4.00	NBR		
BAUMX7	38.00	52.00	7.00	FPM	BAUX2	40.00	50.00	7.00	NBR		
BAUSLX2	38.00	52.00	7.00	NBR	BAFUDX7	40.00	52.00	6.00	NBR		
BAU	38.00	52.00	8.00	NBR	B1FUD	40.00	52.00	7.00	NBR		
B1FUD	38.00	52.00	10.00	NBR	B1FUDSL	40.00	52.00	7.00	NBR		
BAU	38.00	52.00	10.00	NBR	B1USL	40.00	52.00	7.00	NBR		
BA	38.00	54.00	6.50	NBR	BAFUDSLX7	40.00	52.00	7.00	NBR		
B1	38.00	54.00	10.00	NBR	BAFUDX7	40.00	52.00	7.00	NBR		
BA	38.00	54.00	10.00	NBR	BAFUDX7	40.00	52.00	7.00	NBR		
B1U	38.00	55.00	7.00	NBR	BAUMX7	40.00	52.00	7.00	FPM		
BA	38.00	55.00	7.00	NBR	BA	40.00	52.00	8.00	NBR		
BAUMX7	38.00	55.00	7.00	FPM	B1	40.00	52.00	12.00	NBR		

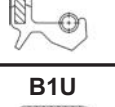
N.B.: MINIMUM LINE ORDER MAY APPLY

## SIMRIT AVAILABILITY LIST

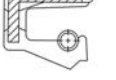
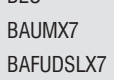
## RADIAL SHAFT SEALS - ALL

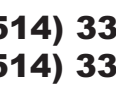
**METRIC SIZE  
SHAFT SEALS**

Design Type	Dimensions	Lip Material	Design Type	Dimensions	Lip Material						
						d	D	H	d	D	H
		B1SL	40.00	54.00	7.00	NBR		40.00	62.00	9.00	NBR
		B1FUD	40.00	55.00	7.00	NBR		40.00	62.00	9.00	NBR
		BAFUDX7	40.00	55.00	7.00	NBR		40.00	62.00	10.00	NBR
		BASL	40.00	55.00	7.00	NBR		40.00	62.00	10.00	NBR
		BAUMSLX7	40.00	55.00	7.00	FPM		40.00	62.00	10.00	NBR
		BAUMX7	40.00	55.00	7.00	FPM		40.00	62.00	10.00	NBR
		BAUX2	40.00	55.00	7.00	NBR		40.00	62.00	10.00	NBR
		B1	40.00	55.00	8.00	NBR		40.00	62.00	10.00	NBR
		BAFUDSLX7	40.00	55.00	8.00	NBR		40.00	62.00	12.00	NBR
		BAFUDX7	40.00	55.00	8.00	NBR		40.00	62.00	12.00	NBR
		B1USL	40.00	55.00	9.00	NBR		40.00	62.00	12.00	NBR
		B2FUD	40.00	55.00	9.00	NBR		40.00	63.50	9.50	NBR
		B1FUD	40.00	55.00	10.00	NBR		40.00	65.00	10.00	NBR
		BASL	40.00	55.00	10.00	NBR		40.00	65.00	10.00	NBR
		BAU	40.00	55.00	10.00	NBR		40.00	65.00	10.00	NBR
		B2FUD	40.00	55.00	12.00	NBR		40.00	65.00	10.00	NBR
		BA	40.00	55.00	12.00	NBR		40.00	65.00	12.00	NBR
		B1U	40.00	55.50	9.00	NBR		40.00	65.00	12.00	NBR
		BAFUDSLX7	40.00	56.00	8.00	NBR		40.00	65.00	12.00	NBR
		BAFUDX7	40.00	56.00	8.00	NBR		40.00	65.00	12.00	NBR
		BASL	40.00	56.00	8.00	NBR		40.00	65.00	20.00	NBR
		B1U	40.00	56.00	10.00	NBR		40.00	68.00	7.00	NBR
		B2U	40.00	56.00	10.00	NBR		40.00	68.00	8.00	NBR
		BAU	40.00	56.00	10.00	NBR		40.00	68.00	10.00	NBR
		B2U	40.00	56.00	12.00	NBR		40.00	68.00	12.00	NBR
		B1U	40.00	58.00	9.00	NBR		40.00	68.00	12.00	NBR
		B1USL	40.00	58.00	9.00	NBR		40.00	70.00	8.00	NBR
		BAFUDSLX7	40.00	58.00	9.00	NBR		40.00	70.00	10.00	NBR
		BAUMSLX7	40.00	58.00	9.00	FPM		40.00	70.00	12.00	NBR
		B2U	40.00	58.00	10.00	NBR		40.00	72.00	7.00	NBR
		BAU	40.00	58.00	12.00	NBR		40.00	72.00	7.00	NBR
		B1U	40.00	60.00	10.00	NBR		40.00	72.00	7.00	NBR
		B2SL	40.00	60.00	10.00	NBR		40.00	72.00	7.00	FPM
		B2U	40.00	60.00	10.00	NBR		40.00	72.00	7.00	NBR
		BAFUDSLX7	40.00	60.00	10.00	NBR		40.00	72.00	9.00	NBR
		BAFUDSLX7	40.00	60.00	10.00	NBR		40.00	72.00	10.00	NBR
		BAFUDX7	40.00	60.00	10.00	NBR		40.00	72.00	10.00	NBR
		BAUMX7	40.00	60.00	10.00	FPM		40.00	72.00	12.00	NBR
		BAUSL	40.00	60.00	10.00	NBR		40.00	72.00	12.00	NBR
		B1	40.00	60.00	12.00	NBR		40.00	72.00	12.00	NBR
		B2U	40.00	60.00	12.00	NBR		40.00	80.00	10.00	NBR
		B1FUD	40.00	62.00	7.00	NBR		40.00	80.00	10.00	FPM
		BAFUDX7	40.00	62.00	7.00	NBR		40.00	80.00	10.00	NBR
		BASL	40.00	62.00	7.00	NBR		40.00	80.00	10.00	NBR
		BAUMSLX7	40.00	62.00	7.00	FPM		40.00	80.00	12.00	NBR
		BAUMX7	40.00	62.00	7.00	FPM		40.00	80.00	13.00	NBR
		BAUSLX2	40.00	62.00	7.00	NBR		40.00	85.00	10.00	FPM
		BAUX2	40.00	62.00	7.00	NBR		40.00	90.00	8.00	NBR

N.B.: MINIMUM LINE ORDER MAY APPLY

Tel.: (514) 334-2220  
Fax: (514) 333-8329

**SS 123**













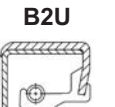
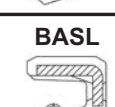

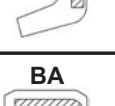

[www.sealsonline.com](http://www.sealsonline.com)

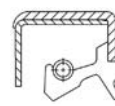
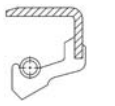

**METRIC SIZE  
SHAFT SEALS**

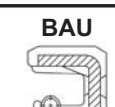
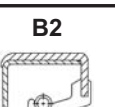
## RADIAL SHAFT SEALS - ALL

## SIMRIT AVAILABILITY LIST













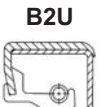

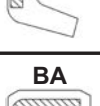

Design Type	Dimensions			Lip Material	Design Type	Dimensions			Lip Material	Diagram	Diagram
	d	D	H			d	D	H			
BAFUDX7	40.00	90.00	10.00	NBR	B2FUD	42.00	72.00	10.00	NBR		
BAFUDSLX7	40.00	90.00	12.00	NBR	BAU	42.00	72.00	10.00	NBR		
B2U	41.00	62.00	10.00	NBR	BAUSLX7	42.00	72.00	10.00	NBR		
B1U	42.00	55.00	7.00	NBR	B1FUD	42.00	72.00	12.00	NBR		
BAU	42.00	55.00	7.00	NBR	B2FUD	42.00	72.00	12.00	NBR		
B1U	42.00	55.00	8.00	NBR	B2	42.00	80.00	13.00	NBR		
BA	42.00	55.00	8.00	NBR	B1U	43.00	58.00	7.50	NBR		
BAFUDSLX7	42.00	55.00	8.00	NBR	B2	43.00	60.00	10.00	NBR		
BAUMSLX7	42.00	55.00	8.00	FPM	BA	43.00	60.00	10.00	NBR		
B1SL	42.00	55.00	10.00	NBR	B2U	43.00	62.00	10.00	NBR		
B1	42.00	56.00	7.00	NBR	B1U	43.00	63.50	9.50	NBR		
BAFUDX7	42.00	56.00	7.00	NBR	B2	43.00	72.00	10.00	NBR		
BAUSL	42.00	56.00	7.00	NBR	BAU	44.00	58.40	10.00	NBR		
B1	42.00	58.00	9.00	NBR	B2U	44.00	60.00	10.00	NBR		
B1U	42.00	60.00	10.00	NBR	BAU	44.00	60.00	10.00	NBR		
B2U	42.00	60.00	10.00	NBR	B2U	44.00	62.00	10.00	NBR		
BA	42.00	60.00	10.00	NBR	BA	44.00	62.00	10.00	NBR		
B2U	42.00	60.00	12.00	NBR	B2U	44.00	62.00	12.00	NBR		
B1SL	42.00	62.00	7.00	NBR	BAUMX7	44.00	65.00	8.00	FPM		
B1U	42.00	62.00	7.00	NBR	B1	44.00	65.00	10.00	NBR		
B1U	42.00	62.00	8.00	NBR	B2U	44.00	65.00	10.00	NBR		
BAFUDSLX7	42.00	62.00	8.00	NBR	BA	44.00	65.00	10.00	NBR		
BAFUDX7	42.00	62.00	8.00	NBR	B2U	44.00	70.00	12.00	NBR		
BAUMX7	42.00	62.00	8.00	FPM	BA	44.00	72.00	10.00	NBR		
BAUX2	42.00	62.00	8.00	NBR	B2	44.00	72.00	12.00	NBR		
B1U	42.00	62.00	10.00	NBR	BAU	44.00	80.00	13.00	NBR		
B2U	42.00	62.00	10.00	NBR	B1U	44.45	63.50	7.94	NBR		
B2USL	42.00	62.00	10.00	NBR	B1OF	45.00	52.00	4.00	NBR		
BAU	42.00	62.00	10.00	NBR	B1OF	45.00	52.00	4.00	NBR		
B1U	42.00	62.00	12.00	NBR	B1FUDSL	45.00	55.00	7.00	NBR		
B1USL	42.00	62.00	12.00	NBR	BAUX2	45.00	55.00	7.00	NBR		
B2U	42.00	62.00	12.00	NBR	BA	45.00	58.00	7.00	NBR		
BA	42.00	62.00	12.00	NBR	BAFUDSLX7	45.00	58.00	7.00	NBR		
B1U	42.00	65.00	10.00	NBR	B1FUD	45.00	60.00	7.00	NBR		
B2U	42.00	65.00	10.00	NBR	B1FUDSL	45.00	60.00	7.00	NBR		
BA	42.00	65.00	10.00	NBR	BAFUDSLX7	45.00	60.00	7.00	NBR		
BAFUDSLX7	42.00	65.00	10.00	NBR	BAFUDX7	45.00	60.00	7.00	NBR		
BAUMX7	42.00	65.00	10.00	FPM	BAUSLX2	45.00	60.00	7.00	NBR		
B1U	42.00	65.00	12.00	NBR	B1FUD	45.00	60.00	8.00	NBR		
B2U	42.00	65.00	12.00	NBR	B2USL	45.00	60.00	8.00	NBR		
B2	42.00	66.00	13.00	NBR	BAFUDX7	45.00	60.00	8.00	NBR		
BAUMX7	42.00	68.00	8.00	FPM	BASL	45.00	60.00	8.00	NBR		
B2	42.00	68.00	10.00	NBR	BAUMSLX7	45.00	60.00	8.00	FPM		
B2	42.00	70.00	12.00	NBR	BAUMX7	45.00	60.00	8.00	FPM		
B1FUD	42.00	72.00	8.00	NBR	B1FUD	45.00	60.00	10.00	NBR		
BA	42.00	72.00	8.00	NBR	B2FUD	45.00	60.00	10.00	NBR		
BAUMX7	42.00	72.00	8.00	FPM	BAU	45.00	60.00	10.00	NBR		
BAUSLX2	42.00	72.00	8.00	NBR	B2FUD	45.00	60.00	12.00	NBR		

N.B.: MINIMUM LINE ORDER MAY APPLY

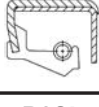
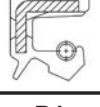
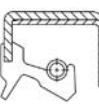
## SIMRIT AVAILABILITY LIST

## RADIAL SHAFT SEALS - ALL

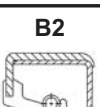
**METRIC SIZE  
SHAFT SEALS**

Design Type	Dimensions	Lip Material	Design Type	Dimensions	Lip Material						
						d	D	H	d	D	H
		BAFUDX7	45.00	62.00	7.00	NBR	BAUSLX7	45.00	75.00	7.00	NBR
		B1U	45.00	62.00	8.00	NBR	BAFUDSLX7	45.00	75.00	8.00	NBR
		BAFUDX7	45.00	62.00	8.00	NBR	BAU	45.00	75.00	8.00	NBR
		BAUMX7	45.00	62.00	8.00	FPM	BAUMSLX7	45.00	75.00	8.00	FPM
		BAUSL	45.00	62.00	8.00	NBR	BAFUDSLX7	45.00	75.00	10.00	NBR
		B1U	45.00	62.00	10.00	NBR	BAFUDX7	45.00	75.00	10.00	NBR
		B2U	45.00	62.00	10.00	NBR	B2	45.00	75.00	12.00	NBR
		B2USL	45.00	62.00	10.00	NBR	BAU	45.00	80.00	8.00	NBR
		BA	45.00	62.00	10.00	NBR	B2U	45.00	80.00	10.00	NBR
		BAFUDSLX7	45.00	62.00	10.00	NBR	BAFUDSLX7	45.00	80.00	10.00	NBR
		BAFUDX7	45.00	62.00	10.00	NBR	BAFUDX7	45.00	80.00	10.00	NBR
		BAUSL	45.00	62.00	10.00	NBR	B1	45.00	80.00	13.00	NBR
		B1U	45.00	62.00	12.00	NBR	B1USL	45.00	80.00	13.00	NBR
		B2FUDSL	45.00	62.00	12.00	NBR	B2U	45.00	80.00	13.00	NBR
		B2U	45.00	62.00	12.00	NBR	BA	45.00	80.00	13.00	NBR
		B1FUD	45.00	65.00	8.00	NBR	B1U	45.00	85.00	10.00	NBR
		BAFUDX7	45.00	65.00	8.00	NBR	BAU	45.00	85.00	10.00	NBR
		BAUMX7	45.00	65.00	8.00	FPM	BAUMSL	45.00	85.00	10.00	FPM
		B1FUD	45.00	65.00	10.00	NBR	BAUSLX2	45.00	85.00	10.00	NBR
		B1FUDSL	45.00	65.00	10.00	NBR	B2	45.00	85.00	13.00	NBR
		B2FUD	45.00	65.00	10.00	NBR	BA	45.00	100.00	10.00	NBR
		BAFUDSLX7	45.00	65.00	10.00	NBR	B1U	46.00	60.00	7.00	NBR
		BAFUDX7	45.00	65.00	10.00	NBR	B2U	46.00	62.00	12.00	NBR
		BASL	45.00	65.00	10.00	NBR	BA	46.00	64.00	8.00	NBR
		BAUMSLX7	45.00	65.00	10.00	FPM	B2U	46.00	65.00	10.00	NBR
		B1FUD	45.00	65.00	12.00	NBR	BAU	46.00	65.00	10.00	NBR
		B2FUD	45.00	65.00	12.00	NBR	B2	46.00	68.00	12.00	NBR
		BA	45.00	66.00	6.00	NBR	B2	46.00	80.00	10.00	NBR
		B2	45.00	68.00	10.00	NBR	BA	46.94	62.00	8.00	NBR
		BAFUDX7	45.00	68.00	10.00	NBR	BA	47.00	62.00	6.00	NBR
		BAUMX7	45.00	68.00	10.00	FPM	BAUMSL	47.00	65.00	10.00	FPM
		B2	45.00	68.00	12.00	NBR	BAUSLX2	47.00	65.00	10.00	NBR
		B2U	45.00	70.00	10.00	NBR	B2U	47.00	65.00	12.00	NBR
		BAFUDSLX7	45.00	70.00	10.00	NBR	B2	47.00	70.00	12.00	NBR
		B1U	45.00	70.00	12.00	NBR	B2	47.00	72.00	10.00	NBR
		B2	45.00	70.00	12.00	NBR	B1	47.00	72.00	12.00	NBR
		B1U	45.00	72.00	7.00	NBR	B2	47.00	72.00	12.00	NBR
		B1FUD	45.00	72.00	8.00	NBR	BAUMSL	47.00	90.00	10.00	FPM
		BAFUDX7	45.00	72.00	8.00	NBR	BAUSLX2	47.00	90.00	10.00	NBR
		BAUMSLX7	45.00	72.00	8.00	FPM	B1FUD	48.00	62.00	8.00	NBR
		BAUMX7	45.00	72.00	8.00	FPM	BAFUDX7	48.00	62.00	8.00	NBR
		BAUSL	45.00	72.00	8.00	NBR	BAUMX7	48.00	62.00	8.00	FPM
		B1FUD	45.00	72.00	10.00	NBR	B1U	48.00	62.00	10.00	NBR
		B2FUD	45.00	72.00	10.00	NBR	BAUMSLX7	48.00	65.00	8.00	FPM
		BAFUDX7	45.00	72.00	10.00	NBR	B1	48.00	65.00	10.00	NBR
		B1FUD	45.00	72.00	12.00	NBR	B1U	48.00	65.00	10.00	NBR
		B2FUD	45.00	72.00	12.00	NBR	B2SL	48.00	65.00	10.00	NBR
		BAU	45.00	75.00	7.00	NBR	B2U	48.00	65.00	10.00	NBR

N.B.: MINIMUM LINE ORDER MAY APPLY

Tel.: (888) 238-5885  
Fax: (888) 238-1664













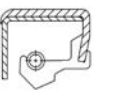

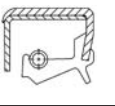
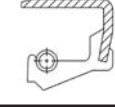

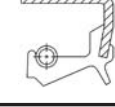
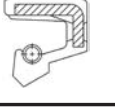
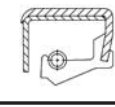

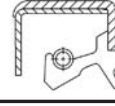
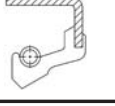
**SS 125**

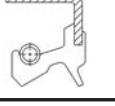
[www.sealsonline.com](http://www.sealsonline.com)

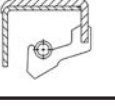
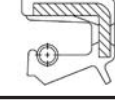
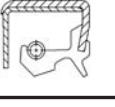

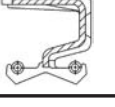
## RADIAL SHAFT SEALS - ALL

## SIMRIT AVAILABILITY LIST

Design Type	Dimensions			Lip Material	Design Type	Dimensions			Lip Material	Diagram	Diagram
	d	D	H			d	D	H			
BAFUDSLX7	48.00	65.00	10.00	NBR	B1	50.00	66.00	10.00	NBR		
BAU	48.00	65.00	10.00	NBR	B1U	50.00	68.00	8.00	NBR		
BAUSL	48.00	65.00	10.00	NBR	BAFUDX7	50.00	68.00	8.00	NBR		
B2U	48.00	65.00	12.00	NBR	BAUMX7	50.00	68.00	8.00	FPM		
BAUMSLX7	48.00	68.00	8.00	FPM	B1U	50.00	68.00	10.00	NBR		
B2U	48.00	68.00	10.00	NBR	B2U	50.00	68.00	10.00	NBR		
BA	48.00	68.00	10.00	NBR	BAFUDSLX7	50.00	68.00	10.00	NBR		
BASL	48.00	68.00	10.00	NBR	BASL	50.00	68.00	10.00	NBR		
B2U	48.00	68.00	12.00	NBR	BAU	50.00	68.00	10.00	NBR		
B1U	48.00	69.00	12.00	NBR	B2U	50.00	68.00	12.00	NBR		
B2	48.00	70.00	10.00	NBR	BA	50.00	68.00	12.00	NBR		
BAU	48.00	70.00	10.00	NBR	B1	50.00	68.00	14.00	NBR		
B2	48.00	70.00	12.00	NBR	BAUMX7	50.00	70.00	8.00	FPM		
B1FUDSL	48.00	72.00	7.00	NBR	BAFUDSLX7	50.00	70.00	9.00	NBR		
BAFUDX7	48.00	72.00	7.00	NBR	B1FUD	50.00	70.00	10.00	NBR		
B1	48.00	72.00	8.00	NBR	B2FUD	50.00	70.00	10.00	NBR		
BAFUDX7	48.00	72.00	8.00	NBR	BAFUDX7	50.00	70.00	10.00	NBR		
BAUMSLX7	48.00	72.00	8.00	FPM	BASL	50.00	70.00	10.00	NBR		
BAUMX7	48.00	72.00	8.00	FPM	B1FUD	50.00	70.00	12.00	NBR		
BAUSL	48.00	72.00	8.00	NBR	B2FUD	50.00	70.00	12.00	NBR		
B2U	48.00	72.00	10.00	NBR	BAU	50.00	70.00	12.00	NBR		
B2U	48.00	72.00	10.00	NBR	B1FUD	50.00	72.00	8.00	NBR		
BAU	48.00	72.00	10.00	NBR	BAFUDX7	50.00	72.00	8.00	NBR		
B1	48.00	72.00	12.00	NBR	BAUMSLX7	50.00	72.00	8.00	FPM		
B2	48.00	72.00	12.00	NBR	BAUMX7	50.00	72.00	8.00	FPM		
BA	48.00	72.00	12.00	NBR	BAUSL	50.00	72.00	8.00	NBR		
BAUSL	48.00	72.00	12.00	NBR	B1FUD	50.00	72.00	10.00	NBR		
B2U	48.00	80.00	10.00	NBR	B2FUD	50.00	72.00	10.00	NBR		
BAFUDX7	48.00	80.00	10.00	NBR	B2USL	50.00	72.00	10.00	NBR		
B2	48.00	80.00	13.00	NBR	BAFUDX7	50.00	72.00	10.00	NBR		
B2	48.00	90.00	13.00	NBR	B1FUD	50.00	72.00	12.00	NBR		
BA	49.00	65.00	10.00	NBR	B2SL	50.00	72.00	12.00	NBR		
B2U	49.00	68.00	10.00	NBR	BAFUDSLX7	50.00	72.00	12.00	NBR		
BAUSLX2	50.00	58.00	8.00	NBR	BAUMSLX7	50.00	75.00	8.00	FPM		
B1FUD	50.00	62.00	7.00	NBR	B1	50.00	75.00	9.00	NBR		
BAFUDSLX7	50.00	62.00	7.00	NBR	BAU	50.00	75.00	10.00	NBR		
B1FUD	50.00	62.00	10.00	NBR	B2FUD	50.00	75.00	12.00	NBR		
B1FUD	50.00	64.00	10.00	NBR	BAU	50.00	78.00	10.00	NBR		
B1FUD	50.00	65.00	8.00	NBR	B2U	50.00	78.00	13.00	NBR		
B1FUDSL	50.00	65.00	8.00	NBR	B1FUD	50.00	80.00	8.00	NBR		
BAFUDSLX7	50.00	65.00	8.00	NBR	BAUMX7	50.00	80.00	8.00	NBR		
BAFUDX7	50.00	65.00	8.00	NBR	BAFUDSLX7	50.00	80.00	8.00	NBR		
BAUMSLX7	50.00	65.00	8.00	FPM	BAFUDSLX7	50.00	80.00	8.00	NBR		
BAUMX7	50.00	65.00	8.00	FPM	BAFUDX7	50.00	80.00	8.00	NBR		
B1U	50.00	65.00	10.00	NBR	BAUMX7	50.00	80.00	8.00	FPM		
B2U	50.00	65.00	10.00	NBR	B1FUD	50.00	80.00	10.00	NBR		
BAU	50.00	65.00	10.00	NBR	B2FUD	50.00	80.00	10.00	NBR		
BAUMSL	50.00	65.00	10.00	FPM	B2FUD	50.00	80.00	10.00	NBR		
BAUSLX2	50.00	65.00	10.00	NBR	B2FUD	50.00	80.00	10.00	NBR		

N.B.: MINIMUM LINE ORDER MAY APPLY













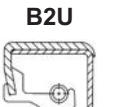
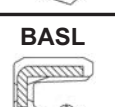

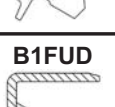

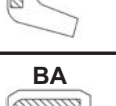
## SIMRIT AVAILABILITY LIST

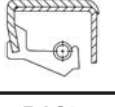
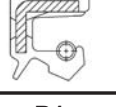
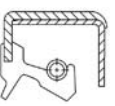
## RADIAL SHAFT SEALS - ALL

**METRIC SIZE  
SHAFT SEALS**

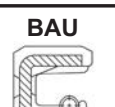
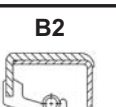

**M**

Design Type	Dimensions	Lip Material	Design Type	Dimensions	Lip Material						
						d	D	H	d	D	H
		BAU	50.00	80.00	10.00	NBR	BA	52.00	85.00	10.00	NBR
		BAUMSL	50.00	80.00	10.00	FPM	BAUMSLX7	52.00	85.00	10.00	FPM
		BAUMSLX7	50.00	80.00	10.00	FPM	B2	52.00	85.00	13.00	NBR
		BAUMSLX7	50.00	80.00	10.00	FPM	B2U	52.00	90.00	13.00	NBR
		BAUSLX2	50.00	80.00	10.00	NBR	BAUMSL	52.00	100.00	10.00	FPM
		B2	50.00	80.00	13.00	NBR	BAUSLX2	52.00	100.00	10.00	NBR
		B2USL	50.00	80.00	13.00	NBR	B2U	53.00	68.00	10.00	NBR
		BA	50.00	80.00	13.00	NBR	BA	53.00	68.00	10.00	NBR
		BAUSL	50.00	80.00	13.00	NBR	B2	53.00	72.00	12.00	NBR
		B2	50.00	85.00	13.00	NBR	B2U	53.00	80.00	13.00	NBR
		BAUSLX7	50.00	90.00	8.00	NBR	B1	53.98	73.03	6.40	NBR
		B1	50.00	90.00	10.00	NBR	B2U	53.98	76.20	12.50	NBR
		BAFUDSLX7	50.00	90.00	10.00	NBR	B1U	54.00	70.00	10.00	NBR
		BAFUDX7	50.00	90.00	10.00	NBR	B2U	54.00	70.00	12.00	NBR
		BAUMSL	50.00	90.00	10.00	FPM	B2U	54.00	72.00	10.00	NBR
		BAUSLX2	50.00	90.00	10.00	NBR	B2	54.00	80.00	10.00	NBR
		B2U	50.00	90.00	13.00	NBR	B2U	54.00	80.00	13.00	NBR
		B1	50.80	76.20	9.50	NBR	BAFUDSLX7	54.00	81.00	10.00	NBR
		B1FUDSL	52.00	68.00	7.00	NBR	B2	54.00	85.00	10.00	NBR
		B1U	52.00	68.00	7.00	NBR	BAFUDSLX7	55.00	68.00	8.00	NBR
		B1U	52.00	68.00	8.00	NBR	BAFUDX7	55.00	68.00	8.00	NBR
		BAFUDSLX7	52.00	68.00	8.00	NBR	B1FUD	55.00	70.00	8.00	NBR
		BAFUDX7	52.00	68.00	8.00	NBR	B1FUDSL	55.00	70.00	8.00	NBR
		BAUMSLX7	52.00	68.00	8.00	FPM	BAFUDSLX7	55.00	70.00	8.00	NBR
		BAUMX7	52.00	68.00	8.00	FPM	BAFUDX7	55.00	70.00	8.00	NBR
		B2U	52.00	68.00	10.00	NBR	BAUMSLX7	55.00	70.00	8.00	FPM
		BA	52.00	68.00	10.00	NBR	BAU	55.00	70.00	10.00	NBR
		B2	52.00	69.00	12.00	NBR	BAUMX7	55.00	70.00	10.00	FPM
		B2U	52.00	70.00	10.00	NBR	B1FUD	55.00	72.00	8.00	NBR
		B1	52.00	72.00	8.00	NBR	BAFUDX7	55.00	72.00	8.00	NBR
		BAFUDX7	52.00	72.00	8.00	NBR	BAUMSLX7	55.00	72.00	8.00	FPM
		BAUMSLX7	52.00	72.00	8.00	FPM	BAUMX7	55.00	72.00	8.00	FPM
		BAUMX7	52.00	72.00	8.00	FPM	BAUSLX2	55.00	72.00	8.00	NBR
		B1	52.00	72.00	10.00	NBR	B1FUD	55.00	72.00	10.00	NBR
		B2U	52.00	72.00	10.00	NBR	B1FUDSL	55.00	72.00	10.00	NBR
		BAU	52.00	72.00	10.00	NBR	B2FUD	55.00	72.00	10.00	NBR
		BAUMSL	52.00	72.00	10.00	FPM	BAFUDSLX7	55.00	72.00	10.00	NBR
		BAUSLX2	52.00	72.00	10.00	NBR	BAFUDX7	55.00	72.00	10.00	NBR
		B1U	52.00	72.00	12.00	NBR	BAUMSLX7	55.00	72.00	10.00	FPM
		B1USL	52.00	72.00	12.00	NBR	BAUSL	55.00	72.00	10.00	NBR
		B2U	52.00	72.00	12.00	NBR	BAUSLX2	55.00	72.00	10.00	NBR
		B2U	52.00	75.00	10.00	NBR	B1FUD	55.00	72.00	12.00	NBR
		BA	52.00	75.00	10.00	NBR	B1FUDSL	55.00	72.00	12.00	NBR
		B2U	52.00	75.00	12.00	NBR	B2FUD	55.00	72.00	12.00	NBR
		B2	52.00	80.00	10.00	NBR	BAUMSLX7	55.00	75.00	8.00	FPM
		BA	52.00	80.00	10.00	NBR	BAUSLX2	55.00	75.00	8.00	NBR
		B2U	52.00	80.00	13.00	NBR	B2U	55.00	75.00	10.00	NBR
		B2	52.00	85.00	10.00	NBR	BAFUDX7	55.00	75.00	10.00	NBR

N.B.: MINIMUM LINE ORDER MAY APPLY

**Tel.: (204) 783-9617**  
**Fax: (204) 783-6091**

**SS 127**

**www.sealsonline.com**



## RADIAL SHAFT SEALS - ALL

## SIMRIT AVAILABILITY LIST

















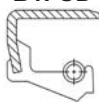





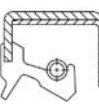

Design Type	Dimensions			Lip Material	Design Type	Dimensions			Lip Material	Diagram	Diagram
	d	D	H			d	D	H			
B1FUD	55.00	75.00	12.00	NBR	BAUMSLX7	56.00	70.00	8.00	FPM		
B2FUD	55.00	75.00	12.00	NBR	BAUSL	56.00	70.00	8.00	NBR		
BAU	55.00	75.00	13.00	NBR	B1U	56.00	72.00	8.00	NBR		
BADUO	55.00	75.00	15.00	NBR	BAU	56.00	72.00	8.00	NBR		
BA	55.00	78.00	10.00	NBR	BAUMSLX7	56.00	72.00	8.00	FPM		
BAUMSLX7	55.00	78.00	10.00	FPM	B2	56.00	72.00	10.00	NBR		
B2	55.00	78.00	13.00	NBR	BA	56.00	72.00	10.00	NBR		
B1FUD	55.00	80.00	8.00	NBR	B2	56.00	78.00	13.00	NBR		
BAFUDX7	55.00	80.00	8.00	NBR	BA	56.00	80.00	8.00	NBR		
BAUMX7	55.00	80.00	8.00	FPM	BAUMX7	56.00	80.00	8.00	FPM		
BAUSL	55.00	80.00	8.00	NBR	B1U	56.00	80.00	10.00	NBR		
B1U	55.00	80.00	10.00	NBR	B2U	56.00	80.00	10.00	NBR		
B2FUDSL	55.00	80.00	10.00	NBR	BA	56.00	85.00	8.00	NBR		
B2U	55.00	80.00	10.00	NBR	BAUMX7	56.00	85.00	8.00	FPM		
BAFUDSLX7	55.00	80.00	10.00	NBR	B2	56.00	90.00	13.00	NBR		
BASL	55.00	80.00	10.00	NBR	B1SL	57.00	72.00	9.00	NBR		
BAU	55.00	80.00	10.00	NBR	B2U	57.00	72.00	10.00	NBR		
BAUMX7	55.00	80.00	10.00	FPM	B2	57.00	80.00	12.00	NBR		
B2U	55.00	80.00	12.00	NBR	B2	57.00	85.00	12.00	NBR		
B1FUDSL	55.00	80.00	13.00	NBR	B1U	57.00	90.00	13.00	NBR		
B1U	55.00	80.00	13.00	NBR	B2	57.00	90.00	13.00	NBR		
B2U	55.00	80.00	13.00	NBR	B2	57.15	76.20	13.00	NBR		
BAU	55.00	80.00	13.00	NBR	B1U	57.15	82.55	9.50	NBR		
B1	55.00	85.00	8.00	NBR	B1FUD	58.00	72.00	8.00	NBR		
BAFUDX7	55.00	85.00	8.00	NBR	BAFUDX7	58.00	72.00	8.00	NBR		
BAUMX7	55.00	85.00	8.00	FPM	BAUMX7	58.00	72.00	8.00	FPM		
B2U	55.00	85.00	10.00	NBR	BAFUDX7	58.00	75.00	10.00	NBR		
BA	55.00	85.00	10.00	NBR	B2FUD	58.00	75.00	12.00	NBR		
BAUMX7	55.00	85.00	10.00	FPM	B2U	58.00	78.00	13.00	NBR		
B1U	55.00	85.00	13.00	NBR	B1U	58.00	80.00	8.00	NBR		
B2	55.00	85.00	13.00	NBR	BAFUDX7	58.00	80.00	8.00	NBR		
BAU	55.00	85.00	13.00	NBR	BAUMX7	58.00	80.00	8.00	FPM		
BAU	55.00	90.00	8.00	NBR	B2U	58.00	80.00	10.00	NBR		
BAUMSLX7	55.00	90.00	8.00	FPM	B2USL	58.00	80.00	10.00	NBR		
BAUSL	55.00	90.00	8.00	NBR	BASL	58.00	80.00	10.00	NBR		
BAFUDSLX7	55.00	90.00	10.00	NBR	BAU	58.00	80.00	10.00	NBR		
BAFUDX7	55.00	90.00	10.00	NBR	B2U	58.00	80.00	12.00	NBR		
BAUMSLX7	55.00	90.00	10.00	FPM	B1U	58.00	80.00	13.00	NBR		
BAUSLX2	55.00	90.00	10.00	NBR	B2USL	58.00	80.00	13.00	NBR		
B2	55.00	90.00	13.00	NBR	B2U	58.00	85.00	10.00	NBR		
BAU	55.00	100.00	10.00	NBR	B2	58.00	85.00	13.00	NBR		
BAUMSL	55.00	100.00	10.00	FPM	BA	58.00	90.00	10.00	NBR		
BAUSLX2	55.00	100.00	10.00	NBR	B2U	58.00	90.00	13.00	NBR		
BAUSLX7	55.00	100.00	10.00	NBR	B1	60.00	70.00	7.00	NBR		
B2U	55.00	100.00	13.00	NBR	B1FUDSL	60.00	72.00	7.00	NBR		
BAUMSLX7	55.00	110.00	10.00	FPM	B1FUD	60.00	72.00	8.00	NBR		
B1	56.00	70.00	8.00	NBR	B1FUD	60.00	75.00	8.00	NBR		
BA	56.00	70.00	8.00	NBR	B1FUD	60.00	75.00	8.00	NBR		

N.B.: MINIMUM LINE ORDER MAY APPLY

## SIMRIT AVAILABILITY LIST

## RADIAL SHAFT SEALS - ALL

**METRIC SIZE  
SHAFT SEALS**

Design Type	Dimensions	Lip Material	Design Type	Dimensions	Lip Material						
						d	D	H	d	D	H
		B1FUDSL	60.00	75.00	8.00	NBR	B2FUD	60.00	90.00	12.00	NBR
		B2FUD	60.00	75.00	8.00	NBR	B1FUD	60.00	90.00	13.00	NBR
		BAFUDX7	60.00	75.00	8.00	NBR	B1USL	60.00	90.00	13.00	NBR
		BASL	60.00	75.00	8.00	NBR	BAFUDX7	60.00	90.00	13.00	NBR
		BAUMSLX7	60.00	75.00	8.00	FPM	BAUMSLX7	60.00	95.00	8.00	FPM
		B1	60.00	78.00	10.00	NBR	BAFUDSLX7	60.00	95.00	10.00	NBR
		BA	60.00	78.00	10.00	NBR	BAFUDX7	60.00	95.00	10.00	NBR
		B2U	60.00	78.00	13.00	NBR	B2U	60.00	95.00	13.00	NBR
		B1FUD	60.00	80.00	8.00	NBR	BAU	60.00	100.00	10.00	NBR
		BAFUDSLX7	60.00	80.00	8.00	NBR	BAUMSL	60.00	110.00	12.00	FPM
		BAFUDX7	60.00	80.00	8.00	NBR	BAUSLX2	60.00	110.00	12.00	NBR
		BAUMSLX7	60.00	80.00	8.00	FPM	BA	60.00	110.00	13.00	NBR
		B1FUD	60.00	80.00	10.00	NBR	B1	61.00	75.00	8.00	NBR
		B2FUD	60.00	80.00	10.00	NBR	B2U	61.00	85.00	13.00	NBR
		BAFUDSLX7	60.00	80.00	10.00	NBR	B1	62.00	75.00	10.00	NBR
		BAFUDX7	60.00	80.00	10.00	NBR	B2U	62.00	80.00	10.00	NBR
		BASL	60.00	80.00	10.00	NBR	BA	62.00	80.00	10.00	NBR
		BAUMX7	60.00	80.00	10.00	FPM	B2U	62.00	80.00	12.00	NBR
		B1FUD	60.00	80.00	12.00	NBR	B1	62.00	85.00	10.00	NBR
		B1USL	60.00	80.00	12.00	NBR	B2U	62.00	85.00	10.00	NBR
		B2FUD	60.00	80.00	12.00	NBR	BA	62.00	85.00	10.00	NBR
		B1FUD	60.00	80.00	13.00	NBR	BAUMX7	62.00	85.00	10.00	FPM
		B2FUD	60.00	80.00	13.00	NBR	B2	62.00	85.00	12.00	NBR
		B2USL	60.00	80.00	13.00	NBR	B2U	62.00	85.00	13.00	NBR
		B1FUD	60.00	85.00	8.00	NBR	B2USL	62.00	85.00	13.00	NBR
		BAFUDX7	60.00	85.00	8.00	NBR	B1	62.00	90.00	10.00	NBR
		BASL	60.00	85.00	8.00	NBR	B2U	62.00	90.00	10.00	NBR
		BAUMX7	60.00	85.00	8.00	FPM	BAFUDX7	62.00	90.00	10.00	NBR
		B2FUD	60.00	85.00	10.00	NBR	BAUMX7	62.00	90.00	10.00	FPM
		BAFUDX7	60.00	85.00	10.00	NBR	B2U	62.00	90.00	12.00	NBR
		BAUMSLX7	60.00	85.00	10.00	FPM	BAUMSL	62.00	90.00	12.00	FPM
		B2FUD	60.00	85.00	12.00	NBR	BAUSLX2	62.00	90.00	12.00	NBR
		B1FUD	60.00	85.00	13.00	NBR	B1U	62.00	90.00	13.00	NBR
		B1FUDSL	60.00	85.00	13.00	NBR	B1U	62.00	95.00	13.00	NBR
		B2FUD	60.00	85.00	13.00	NBR	B2	62.00	100.00	13.00	NBR
		BA	60.00	85.00	13.00	NBR	BAUMSL	62.00	120.00	12.00	FPM
		B1FUD	60.00	90.00	8.00	NBR	BAUSLX2	62.00	120.00	12.00	NBR
		BAFUDSLX7	60.00	90.00	8.00	NBR	B1	63.00	85.00	10.00	NBR
		BAFUDX7	60.00	90.00	8.00	NBR	B2U	63.00	85.00	10.00	NBR
		BAUMSLX7	60.00	90.00	8.00	FPM	BAU	63.00	85.00	10.00	NBR
		BAUMX7	60.00	90.00	8.00	FPM	BAUMX7	63.00	85.00	10.00	FPM
		B1FUD	60.00	90.00	10.00	NBR	B2U	63.00	85.00	12.00	NBR
		B1USL	60.00	90.00	10.00	NBR	B2	63.00	85.00	13.00	NBR
		B2FUD	60.00	90.00	10.00	NBR	BA	63.00	90.00	10.00	NBR
		BAFUDSLX7	60.00	90.00	10.00	NBR	BAUMSLX7	63.00	90.00	10.00	FPM
		BAU	60.00	90.00	10.00	NBR	BAUMX7	63.00	90.00	10.00	FPM
		BAUMX7	60.00	90.00	10.00	FPM	B2	63.00	90.00	12.00	NBR
		B1FUD	60.00	90.00	12.00	NBR	B2U	63.50	82.55	9.50	NBR

N.B.: MINIMUM LINE ORDER MAY APPLY

Tel.: (780) 414-1871  
Fax: (780) 487-5419

**SS 129**

[www.sealsonline.com](http://www.sealsonline.com)



## RADIAL SHAFT SEALS - ALL

## SIMRIT AVAILABILITY LIST













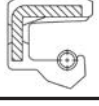

Design Type	Dimensions			Lip Material	Design Type	Dimensions			Lip Material	Diagram	Diagram
	d	D	H			d	D	H			
B1	64.00	80.00	8.00	NBR	B2U	65.00	95.00	13.00	NBR		
BAFUDX7	64.00	80.00	8.00	NBR	B1U	65.00	100.00	10.00	NBR		
B2	64.00	80.00	13.00	NBR	B2U	65.00	100.00	10.00	NBR		
B2U	64.00	85.00	10.00	NBR	BAFUDSLX7	65.00	100.00	10.00	NBR		
B2U	64.00	85.00	13.00	NBR	BAFUDX7	65.00	100.00	10.00	NBR		
B2U	64.00	90.00	10.00	NBR	BAU	65.00	100.00	10.00	NBR		
BA	64.00	90.00	10.00	NBR	BAUMSLX7	65.00	100.00	10.00	FPM		
B1USL	64.00	90.00	13.00	NBR	BAUMSLX7	65.00	100.00	10.00	FPM		
B2	64.00	90.00	13.00	NBR	BAUMX7	65.00	100.00	10.00	FPM		
B2USL	64.00	90.00	13.00	NBR	BAUSL	65.00	100.00	10.00	NBR		
B10F	65.00	75.00	8.00	NBR	B2	65.00	100.00	12.00	NBR		
B10F	65.00	75.00	8.00	NBR	BA	65.00	100.00	12.00	NBR		
B1FUD	65.00	80.00	8.00	NBR	BAUMSL	65.00	100.00	12.00	FPM		
BAFUDX7	65.00	80.00	8.00	NBR	BAUSLX2	65.00	100.00	12.00	NBR		
BAUMSLX7	65.00	80.00	8.00	FPM	B1FUDSL	65.00	100.00	13.00	NBR		
B1FUD	65.00	85.00	10.00	NBR	B2U	65.00	100.00	13.00	NBR		
B2FUD	65.00	85.00	10.00	NBR	BAU	65.00	120.00	10.00	NBR		
BAFUDX7	65.00	85.00	10.00	NBR	BAUSLX7	65.00	120.00	10.00	NBR		
BASL	65.00	85.00	10.00	NBR	BAUMSL	65.00	120.00	12.00	FPM		
BAUMSLX7	65.00	85.00	10.00	FPM	BAUSLX2	65.00	120.00	12.00	NBR		
BAUMX7	65.00	85.00	10.00	FPM	BAUMSLX7	65.00	140.00	12.00	FPM		
B2FUD	65.00	85.00	12.00	NBR	BAUSLX2	65.00	140.00	12.00	NBR		
BAU	65.00	85.00	12.00	NBR	BAUX2	65.00	140.00	12.00	NBR		
BAUMSL	65.00	85.00	12.00	FPM	B2	66.00	90.00	13.00	NBR		
BAUMX7	65.00	85.00	12.00	FPM	B1	67.00	80.00	10.00	NBR		
BAUSLX2	65.00	85.00	12.00	NBR	B2FUD	67.00	85.00	10.00	NBR		
B1FUD	65.00	85.00	13.00	NBR	B2	67.00	90.00	10.00	NBR		
B1SL	65.00	85.00	13.00	NBR	B2	67.00	90.00	13.00	NBR		
B2FUD	65.00	85.00	13.00	NBR	B1	68.00	78.00	7.00	NBR		
BAFUDSLX7	65.00	85.00	13.00	NBR	B1FUD	68.00	85.00	10.00	NBR		
B1FUD	65.00	90.00	10.00	NBR	BAFUDX7	68.00	85.00	10.00	FPM		
B1USL	65.00	90.00	10.00	NBR	BASL	68.00	87.00	8.00	NBR		
B2FUD	65.00	90.00	10.00	NBR	B1U	68.00	90.00	10.00	NBR		
BAFUDSLX7	65.00	90.00	10.00	NBR	B1USL	68.00	90.00	10.00	NBR		
BAFUDSLX7	65.00	90.00	10.00	NBR	B2	68.00	90.00	10.00	NBR		
BAFUDX7	65.00	90.00	10.00	NBR	B2SL	68.00	90.00	10.00	NBR		
BAUMSLX7	65.00	90.00	10.00	FPM	BAFUDX7	68.00	90.00	10.00	NBR		
BAUMX7	65.00	90.00	10.00	FPM	BAUMSLX7	68.00	90.00	10.00	FPM		
B1FUD	65.00	90.00	12.00	NBR	BAUMX7	68.00	90.00	10.00	FPM		
B2FUD	65.00	90.00	12.00	NBR	BAUSL	68.00	90.00	10.00	NBR		
B2USL	65.00	90.00	12.00	NBR	B2U	68.00	90.00	12.00	NBR		
BAUMX7	65.00	90.00	12.00	FPM	B1FUDSL	68.00	90.00	13.00	NBR		
B1FUD	65.00	90.00	13.00	NBR	B1U	68.00	90.00	13.00	NBR		
B1USL	65.00	90.00	13.00	NBR	B2U	68.00	95.00	13.00	NBR		
B2FUD	65.00	90.00	13.00	NBR	B2	68.00	100.00	10.00	NBR		
BA	65.00	90.00	13.00	NBR	BA	68.00	100.00	10.00	NBR		
BAFUDX7	65.00	95.00	10.00	NBR	BAUMX7	68.00	100.00	10.00	FPM		
BAUMX7	65.00	95.00	10.00	FPM	B2U	68.00	100.00	12.00	NBR		

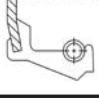
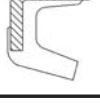
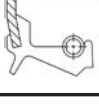
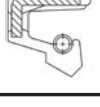
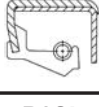
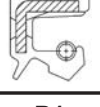
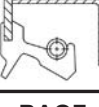
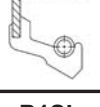
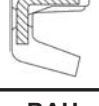
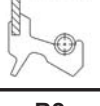
N.B.: MINIMUM LINE ORDER MAY APPLY

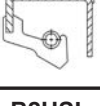
## SIMRIT AVAILABILITY LIST

## RADIAL SHAFT SEALS - ALL

**METRIC SIZE  
SHAFT SEALS**

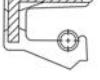
Design Type	Dimensions	Lip Material	Design Type	Dimensions	Lip Material						
						d	D	H	d	D	H
		BAU	69.00	90.00	10.00	NBR	BAUSL	70.00	110.00	10.00	NBR
		B1FUDSL	70.00	80.00	8.00	NBR	BAUMSL	70.00	110.00	12.00	FPM
		BAFUDX7	70.00	85.00	7.00	NBR	BAUSLX2	70.00	110.00	12.00	NBR
		B1FUD	70.00	85.00	8.00	NBR	B1U	70.00	110.00	13.00	NBR
		B1FUDSL	70.00	85.00	8.00	NBR	B2	70.00	110.00	13.00	NBR
		BAFUDSLX7	70.00	85.00	8.00	NBR	BAFUDSLX7	70.00	110.00	13.00	NBR
		BAFUDX7	70.00	85.00	8.00	NBR	BAU	70.00	110.00	13.00	NBR
		BAUMX7	70.00	85.00	8.00	FPM	BAFUDSLX7	70.00	120.00	10.00	NBR
		B1FUD	70.00	90.00	10.00	NBR	BAU	70.00	125.00	12.00	NBR
		B2FUD	70.00	90.00	10.00	NBR	BAUSLX7	70.00	125.00	12.00	NBR
		BAFUDSLX7	70.00	90.00	10.00	NBR	BAUSLX2	70.00	130.00	12.00	NBR
		BAFUDSLX7	70.00	90.00	10.00	NBR	B1	72.00	84.00	7.00	NBR
		BAFUDX7	70.00	90.00	10.00	NBR	BAUMX7	72.00	84.00	7.00	FPM
		BAU	70.00	90.00	10.00	NBR	B1U	72.00	84.00	18.00	NBR
		BAUMX7	70.00	90.00	10.00	NBR	B2U	72.00	90.00	10.00	NBR
		B1FUD	70.00	90.00	12.00	NBR	BA	72.00	90.00	10.00	NBR
		B2FUD	70.00	90.00	12.00	NBR	B2U	72.00	90.00	13.00	NBR
		BAUMSL	70.00	90.00	12.00	FPM	B1U	72.00	95.00	10.00	NBR
		BAUMX7	70.00	90.00	12.00	FPM	B2U	72.00	95.00	10.00	NBR
		BAUSLX2	70.00	90.00	12.00	NBR	BAFUDSLX7	72.00	95.00	10.00	NBR
		B1FUD	70.00	90.00	13.00	NBR	BAFUDX7	72.00	95.00	10.00	NBR
		B1SL	70.00	90.00	13.00	NBR	BAUMX7	72.00	95.00	10.00	FPM
		B2FUD	70.00	90.00	13.00	NBR	B2U	72.00	95.00	12.00	NBR
		B2USL	70.00	90.00	13.00	NBR	BAUMSL	72.00	95.00	12.00	FPM
		BAU	70.00	90.00	13.00	NBR	B1U	72.00	95.00	13.00	NBR
		BAUSL	70.00	90.00	13.00	NBR	B2U	72.00	95.00	13.00	NBR
		B1	70.00	95.00	8.00	NBR	B1	72.00	100.00	10.00	NBR
		B2U	70.00	95.00	10.00	NBR	B2U	72.00	100.00	10.00	NBR
		BAU	70.00	95.00	10.00	NBR	BAU	72.00	100.00	10.00	NBR
		BAUMSLX7	70.00	95.00	12.00	FPM	BAUMSLX7	72.00	100.00	10.00	FPM
		B1	70.00	95.00	13.00	NBR	BAUMX7	72.00	100.00	10.00	FPM
		B1SL	70.00	95.00	13.00	NBR	B2	72.00	100.00	12.00	NBR
		B2U	70.00	95.00	13.00	NBR	B2	72.00	100.00	13.00	NBR
		BAU	70.00	95.00	13.00	NBR	B1USL	72.00	105.00	13.00	NBR
		B2	70.00	98.00	13.00	NBR	B2	72.00	105.00	13.00	NBR
		BA	70.00	100.00	6.00	NBR	B2	72.00	110.00	13.00	NBR
		B1FUD	70.00	100.00	10.00	NBR	BAUMSL	72.00	140.00	12.00	FPM
		B2FUD	70.00	100.00	10.00	NBR	BAUSLX2	72.00	140.00	12.00	NBR
		BAFUDX7	70.00	100.00	10.00	NBR	B2U	73.00	95.00	10.00	NBR
		BAUMX7	70.00	100.00	10.00	FPM	B2	73.00	100.00	13.00	NBR
		BAUSL	70.00	100.00	10.00	NBR	B2U	74.00	90.00	10.00	NBR
		B2FUD	70.00	100.00	12.00	NBR	BA	74.00	90.00	10.00	NBR
		BA	70.00	100.00	12.00	NBR	B2U	74.00	95.00	10.00	NBR
		B1FUD	70.00	100.00	13.00	NBR	BAFUDX7	74.00	95.00	10.00	NBR
		B2FUD	70.00	100.00	13.00	NBR	B2	74.00	100.00	13.00	NBR
		BAU	70.00	100.00	13.00	NBR	BAU	75.00	90.00	8.00	NBR
		B2	70.00	105.00	13.00	NBR	BAUMSLX7	75.00	90.00	10.00	FPM
		BAU	70.00	110.00	8.00	NBR	BAUMX7	75.00	90.00	10.00	FPM

N.B.: MINIMUM LINE ORDER MAY APPLY

Tel.: (604) 278-6808  
Fax: (604) 278-6180













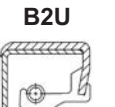
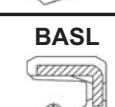



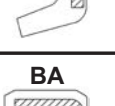

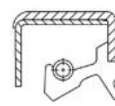
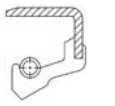

**SS 131**

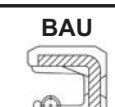
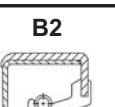
[www.sealsonline.com](http://www.sealsonline.com)

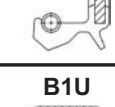

## RADIAL SHAFT SEALS - ALL

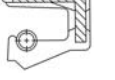
## SIMRIT AVAILABILITY LIST



















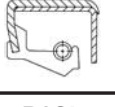
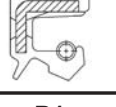

Design Type	Dimensions			Lip Material	Design Type	Dimensions			Lip Material	Diagram	Diagram
	d	D	H			d	D	H			
B2U	75.00	90.00	12.00	NBR	BAU	76.00	100.00	10.00	NBR		
BADUO	75.00	90.00	15.00	NBR	B2	76.00	100.00	13.00	NBR		
BAFUDSLX7	75.00	95.00	9.00	NBR	B2	76.00	110.00	13.00	NBR		
BASL	75.00	95.00	9.00	NBR	B2U	76.20	101.60	11.90	NBR		
B1FUD	75.00	95.00	10.00	NBR	B2U	77.00	95.00	10.00	NBR		
B1FUDSL	75.00	95.00	10.00	NBR	B2U	77.00	100.00	10.00	NBR		
B2FUD	75.00	95.00	10.00	NBR	B2	78.00	95.00	13.00	NBR		
BAFUDX7	75.00	95.00	10.00	NBR	B1	78.00	100.00	10.00	NBR		
BASL	75.00	95.00	10.00	NBR	B2	78.00	100.00	10.00	NBR		
BAUMX7	75.00	95.00	10.00	FPM	BAU	78.00	100.00	10.00	NBR		
B1USL	75.00	95.00	12.00	NBR	BAUMX7	78.00	100.00	10.00	FPM		
B1USL	75.00	95.00	12.00	NBR	B2	78.00	100.00	12.00	NBR		
B2FUD	75.00	95.00	12.00	NBR	B2	78.00	105.00	13.00	NBR		
BASL	75.00	95.00	12.00	NBR	B2	78.00	110.00	13.00	NBR		
BAU	75.00	95.00	12.00	NBR	BAOF	80.00	90.00	5.00	NBR		
BAUMX7	75.00	95.00	12.00	FPM	BAOF	80.00	95.00	5.00	NBR		
BAUSLX2	75.00	95.00	12.00	NBR	B2U	80.00	95.00	10.00	NBR		
B1FUD	75.00	95.00	13.00	NBR	B1FUD	80.00	100.00	10.00	NBR		
B2	75.00	95.00	13.00	NBR	B1FUDSL	80.00	100.00	10.00	NBR		
B1FUD	75.00	100.00	10.00	NBR	B2FUD	80.00	100.00	10.00	NBR		
B2FUD	75.00	100.00	10.00	NBR	B2FUD	80.00	100.00	10.00	NBR		
BAFUDSLX7	75.00	100.00	10.00	NBR	BAFUD	80.00	100.00	10.00	NBR		
BAFUDSLX7	75.00	100.00	10.00	NBR	BAFUDSLX7	80.00	100.00	10.00	NBR		
BAFUDX7	75.00	100.00	10.00	NBR	BAFUDX7	80.00	100.00	10.00	NBR		
BAUMSLX7	75.00	100.00	10.00	FPM	BAUMSLX7	80.00	100.00	10.00	FPM		
BAUMX7	75.00	100.00	10.00	FPM	BAUMX7	80.00	100.00	10.00	FPM		
B1FUD	75.00	100.00	12.00	NBR	BAUSL	80.00	100.00	10.00	NBR		
B2FUD	75.00	100.00	12.00	NBR	B1USL	80.00	100.00	12.00	NBR		
BAFUDSLX7	75.00	100.00	12.00	NBR	B2FUD	80.00	100.00	12.00	NBR		
BAUMX7	75.00	100.00	12.00	FPM	B2USL	80.00	100.00	12.00	NBR		
B1FUDSL	75.00	100.00	13.00	NBR	BAUMSLX7	80.00	100.00	12.00	FPM		
B2	75.00	100.00	13.00	NBR	BAUMX7	80.00	100.00	12.00	FPM		
B2FUDSL	75.00	100.00	13.00	NBR	BAUSLX2	80.00	100.00	12.00	NBR		
BAU	75.00	100.00	13.00	NBR	B1FUD	80.00	100.00	13.00	NBR		
BAFUDX7	75.00	105.00	12.00	NBR	B1FUDSL	80.00	100.00	13.00	NBR		
B1	75.00	105.00	13.00	NBR	B2FUD	80.00	100.00	13.00	NBR		
B2U	75.00	105.00	13.00	NBR	B2FUDSL	80.00	100.00	13.00	NBR		
BAFUDX7	75.00	110.00	12.00	NBR	BASL	80.00	100.00	13.00	NBR		
B1U	75.00	110.00	13.00	NBR	BAU	80.00	100.00	13.00	NBR		
B2U	75.00	110.00	13.00	NBR	B1FUD	80.00	105.00	13.00	NBR		
BAFUDSLX7	75.00	110.00	13.00	NBR	B1USL	80.00	105.00	13.00	NBR		
BAUMSLX7	75.00	115.00	12.00	FPM	B2FUD	80.00	105.00	13.00	NBR		
B2FUD	75.00	115.00	13.00	NBR	BAFUDX7	80.00	105.00	13.00	NBR		
BAU	75.00	120.00	12.00	NBR	B1U	80.00	105.00	15.00	NBR		
BAUSLX7	75.00	120.00	12.00	NBR	B1	80.00	110.00	10.00	NBR		
BAUMSL	75.00	130.00	12.00	FPM	BA	80.00	110.00	10.00	NBR		
BAUSLX2	75.00	130.00	12.00	NBR	BAFUDSLX7	80.00	110.00	10.00	NBR		
B1	76.00	95.00	10.00	NBR	BAUMSLX7	80.00	110.00	10.00	FPM		
					BAUMX7	80.00	110.00	10.00	FPM		

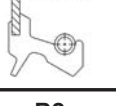
N.B.: MINIMUM LINE ORDER MAY APPLY

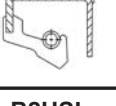
## SIMRIT AVAILABILITY LIST

## RADIAL SHAFT SEALS - ALL

**METRIC SIZE  
SHAFT SEALS**

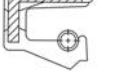
Design Type	Dimensions	Lip Material	Design Type	Dimensions	Lip Material						
						d	D	H	d	D	H
		B2U	80.00	110.00	12.00	NBR	BAUSLX2	85.00	110.00	12.00	NBR
		BA	80.00	110.00	12.00	NBR	B1FUDSL	85.00	110.00	13.00	NBR
		B1U	80.00	110.00	13.00	NBR	B2FUD	85.00	110.00	13.00	NBR
		B2U	80.00	110.00	13.00	NBR	B2FUDSL	85.00	110.00	13.00	NBR
		BAFUDX7	80.00	110.00	13.00	NBR	BAFUDX7	85.00	110.00	13.00	NBR
		BA	80.00	115.00	10.00	NBR	B2FUD	85.00	110.00	15.00	NBR
		B1U	80.00	115.00	13.00	NBR	B2U	85.00	115.00	13.00	NBR
		B2	80.00	120.00	13.00	NBR	BAU	85.00	115.00	13.00	NBR
		BAFUDX7	80.00	120.00	13.00	NBR	B1	85.00	120.00	12.00	NBR
		BAUMSL	80.00	125.00	12.00	FPM	BA	85.00	120.00	12.00	NBR
		BAUSLX2	80.00	125.00	12.00	NBR	BAUMX7	85.00	120.00	12.00	FPM
		B2U	80.00	125.00	13.00	NBR	B2U	85.00	120.00	13.00	NBR
		BAU	80.00	125.00	13.00	NBR	B2	85.00	120.00	15.00	NBR
		BAU	80.00	140.00	13.00	NBR	B2U	85.00	125.00	13.00	NBR
		BAUMSLX7	80.00	140.00	13.00	FPM	BAU	85.00	130.00	10.00	NBR
		BAUSLX7	80.00	140.00	13.00	NBR	BAUSLX7	85.00	130.00	10.00	NBR
		BAUMSL	80.00	170.00	13.00	FPM	BAU	85.00	130.00	12.00	NBR
		BAUSLX2	80.00	170.00	13.00	NBR	B2U	85.00	130.00	13.00	NBR
		B2	81.00	100.00	10.00	NBR	BAU	85.00	140.00	12.00	NBR
		B2	81.00	100.00	13.00	NBR	BAUMSLX7	85.00	140.00	12.00	FPM
		BAUMX7	82.00	100.00	10.00	FPM	BAUSL	85.00	140.00	12.00	NBR
		BASL	82.00	105.00	10.00	NBR	BAUSLX2	85.00	140.00	12.00	NBR
		BAU	82.00	105.00	12.00	NBR	BAU	85.00	150.00	12.00	NBR
		B2U	82.00	105.00	13.00	NBR	BAUSLX7	85.00	150.00	12.00	NBR
		B2	82.00	110.00	13.00	NBR	BA	86.00	105.00	13.00	NBR
		BAUMSL	82.00	120.00	13.00	FPM	BA	86.00	110.00	13.00	NBR
		BAUSLX2	82.00	120.00	13.00	NBR	B2U	87.00	110.00	13.00	NBR
		BAUMSL	82.00	160.00	13.00	FPM	B1USL	88.00	110.00	13.00	NBR
		BAUSLX2	82.00	160.00	13.00	NBR	B2U	88.00	110.00	13.00	NBR
		B2U	82.55	114.30	13.00	NBR	B2U	88.00	120.00	13.00	NBR
		B2U	84.00	105.00	13.00	NBR	BAUMSLX7	88.00	160.00	13.00	FPM
		B2	84.00	110.00	12.00	NBR	BAUSLX2	88.00	160.00	13.00	NBR
		B1USL	85.00	100.00	7.00	NBR	B2	89.00	110.00	13.00	NBR
		B1FUD	85.00	100.00	9.00	NBR	B1FUD	90.00	110.00	8.00	NBR
		B1FUDSL	85.00	100.00	12.00	NBR	B2	90.00	110.00	8.00	NBR
		B2U	85.00	100.00	13.00	NBR	BAFUDX7	90.00	110.00	8.00	NBR
		B1FUD	85.00	105.00	10.00	NBR	BAU	90.00	110.00	10.00	NBR
		BAUMSLX7	85.00	105.00	12.00	FPM	BAUSL	90.00	110.00	10.00	NBR
		B1U	85.00	105.00	13.00	NBR	B1FUD	90.00	110.00	12.00	NBR
		B2SL	85.00	105.00	13.00	NBR	BAFUDX7	90.00	110.00	12.00	NBR
		B2U	85.00	105.00	13.00	NBR	BAUMX7	90.00	110.00	12.00	FPM
		BAFUDX7	85.00	105.00	13.00	NBR	BAUSL	90.00	110.00	12.00	NBR
		BAUMX7	85.00	110.00	10.00	FPM	B1FUD	90.00	110.00	13.00	NBR
		B1FUD	85.00	110.00	12.00	NBR	B2FUD	90.00	110.00	13.00	NBR
		BAFUDSLX7	85.00	110.00	12.00	NBR	B2USL	90.00	110.00	13.00	NBR
		BAFUDX7	85.00	110.00	12.00	NBR	BASL	90.00	110.00	13.00	NBR
		BAUMSLX7	85.00	110.00	12.00	FPM	BAU	90.00	110.00	13.00	NBR
		BAUMX7	85.00	110.00	12.00	FPM	B2U	90.00	110.00	15.00	NBR

N.B.: MINIMUM LINE ORDER MAY APPLY

Tel.: (418) 688-3202  
Fax: (418) 688-4272

**SS 133**

[www.sealsonline.com](http://www.sealsonline.com)















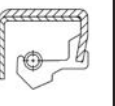

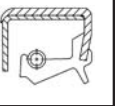

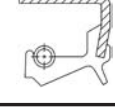
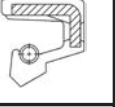
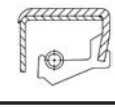
**METRIC SIZE  
SHAFT SEALS**

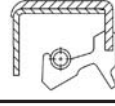
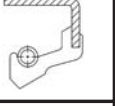

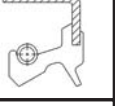
**M**

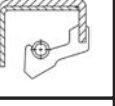
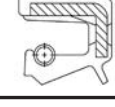
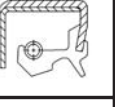
## RADIAL SHAFT SEALS - ALL

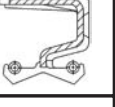
## SIMRIT AVAILABILITY LIST

Design Type	Dimensions			Lip Material	Design Type	Dimensions			Lip Material	BAFUDX7 	B1USL 
	d	D	H			d	D	H			
B2FUD	90.00	112.71	13.00	NBR	B1U	95.00	125.00	13.00	NBR		
B2	90.00	115.00	9.00	NBR	B2U	95.00	125.00	13.00	NBR		
BAU	90.00	115.00	12.00	NBR	BAUMSLX7	95.00	125.00	13.00	FPM	<b>BAUMX7</b> 	<b>B2U</b> 
B1FUD	90.00	115.00	13.00	NBR	BAUSLX2	95.00	125.00	13.00	NBR		
B1FUDSL	90.00	115.00	13.00	NBR	B2	95.00	125.00	15.00	NBR		
B1FUD	90.00	120.00	12.00	NBR	B2U	95.00	130.00	13.00	NBR		
BAFUDX7	90.00	120.00	12.00	NBR	BAU	95.00	145.00	13.00	NBR		
BAUMSLX7	90.00	120.00	12.00	FPM	BAUMSL	95.00	145.00	13.00	FPM	<b>BASL</b> 	<b>B2FUDSL</b> 
BAUMX7	90.00	120.00	12.00	FPM	BAUSLX2	95.00	145.00	13.00	NBR		
B1FUD	90.00	120.00	13.00	NBR	BAUSLX7	95.00	145.00	13.00	NBR		
B2FUD	90.00	120.00	13.00	NBR	BAUMSL	95.00	170.00	13.00	FPM		
B2FUDSL	90.00	120.00	13.00	NBR	BAUSLX2	95.00	170.00	13.00	NBR	<b>B1FUD</b> 	<b>B1OF</b> 
BAFUDSLX7	90.00	120.00	13.00	NBR	B2U	96.00	125.00	13.00	NBR		
BAU	90.00	120.00	13.00	NBR	B2	97.00	120.00	13.00	NBR		
B2FUD	90.00	120.00	15.00	NBR	B2	98.00	120.00	13.00	NBR		
B2	90.00	125.00	13.00	NBR	B2	98.00	125.00	13.00	NBR		
BAFUDX7	90.00	130.00	12.00	NBR	B2	98.00	128.00	10.00	NBR		
BAUMSLX7	90.00	130.00	12.00	FPM	B2	98.00	130.00	13.00	NBR	<b>B1FUDSL</b> 	<b>BA</b> 
B1	90.00	130.00	13.00	NBR	B1FUD	100.00	115.00	9.00	NBR		
B1U	90.00	130.00	13.00	NBR	B1U	100.00	115.00	9.00	NBR		
B2	90.00	130.00	13.00	NBR	B1U	100.00	120.00	8.00	NBR	<b>B2FUD</b> 	<b>BAUSL</b> 
BA	90.00	130.00	13.00	NBR	B1FUD	100.00	120.00	10.00	NBR		
B2	90.00	140.00	13.00	NBR	BAUX2	100.00	120.00	10.00	NBR		
BA	90.00	140.00	13.00	NBR	B1FUD	100.00	120.00	12.00	NBR	<b>B2SL</b> 	<b>B1</b> 
BA	92.00	120.00	12.00	NBR	B2U	100.00	120.00	12.00	NBR		
B2	92.00	120.00	13.00	NBR	BAFUDSLX7	100.00	120.00	12.00	NBR		
B2U	93.00	110.00	13.00	NBR	BAFUDX7	100.00	120.00	12.00	NBR		
B2	94.00	120.00	13.00	NBR	BAUMSLX7	100.00	120.00	12.00	FPM	<b>BAOF</b> 	<b>B1SL</b> 
B1	95.00	110.00	9.00	NBR	BAUMX7	100.00	120.00	12.00	FPM		
B1FUD	95.00	115.00	13.00	NBR	B2FUD	100.00	120.00	13.00	NBR		
B1USL	95.00	115.00	13.00	NBR	B2U	100.00	120.00	15.00	NBR	<b>BAU</b> 	<b>B2</b> 
B2FUD	95.00	115.00	13.00	NBR	B1FUD	100.00	125.00	12.00	NBR		
BAUMX7	95.00	115.00	13.00	FPM	BAFUDX7	100.00	125.00	12.00	NBR		
B1FUD	95.00	120.00	12.00	NBR	BAUMX7	100.00	125.00	12.00	FPM		
BAFUDX7	95.00	120.00	12.00	NBR	B1FUD	100.00	125.00	13.00	NBR		
BASL	95.00	120.00	12.00	NBR	B1USL	100.00	125.00	13.00	NBR		
BAUMX7	95.00	120.00	12.00	FPM	B2FUD	100.00	125.00	13.00	NBR	<b>BAFUDSLX7</b> 	<b>B2USL</b> 
B1FUD	95.00	120.00	13.00	NBR	B2SL	100.00	125.00	13.00	NBR		
B2FUD	95.00	120.00	13.00	NBR	BA	100.00	125.00	13.00	NBR		
B2FUDSL	95.00	120.00	13.00	NBR	BAFUDSLX7	100.00	125.00	13.00	NBR		
B2USL	95.00	120.00	13.00	NBR	B2FUD	100.00	125.00	15.00	NBR	<b>BAUMSLX7</b> 	<b>BADUO</b> 
BA	95.00	120.00	13.00	NBR	BA	100.00	130.00	10.00	NBR		
B2FUD	95.00	120.00	15.00	NBR	B1FUD	100.00	130.00	12.00	NBR		
B1	95.00	125.00	12.00	NBR	BA	100.00	130.00	12.00	NBR		
BA	95.00	125.00	12.00	NBR	BAFUDX7	100.00	130.00	12.00	NBR		
BAFUDSLX7	95.00	125.00	12.00	NBR	BAUMX7	100.00	130.00	12.00	FPM	<b>B1U</b> 	<b>BAFUDX7</b> 
BAUMSLX7	95.00	125.00	12.00	FPM	B1FUD	100.00	130.00	13.00	NBR		
BAUMX7	95.00	125.00	12.00	FPM	B2FUD	100.00	130.00	13.00	NBR		

N.B.: MINIMUM LINE ORDER MAY APPLY

**METRIC SIZE  
SHAFT SEALS**

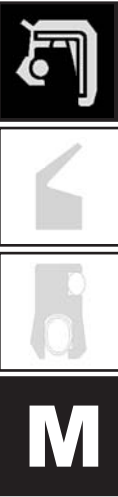

## SIMRIT AVAILABILITY LIST

## RADIAL SHAFT SEALS - ALL

Design Type	Dimensions	Lip Material	Design Type	Dimensions	Lip Material						
						d	D	H	d	D	H
		B2USL	100.00	130.00	13.00	NBR	B1	110.00	128.00	9.00	NBR
		BAFUDSLX7	100.00	130.00	13.00	NBR	B1USL	110.00	128.00	9.00	NBR
		BAFUDSLX7	100.00	130.00	13.00	NBR	B2	110.00	128.00	9.00	NBR
		BASL	100.00	130.00	13.00	NBR	BAUMX7	110.00	128.00	12.00	FPM
		BAUSLX2	100.00	130.00	13.00	NBR	B1FUD	110.00	130.00	10.00	NBR
		B2FUD	100.00	130.00	15.00	NBR	B1FUD	110.00	130.00	12.00	NBR
		BAU	100.00	135.00	13.00	NBR	B1USL	110.00	130.00	12.00	NBR
		B2U	100.00	140.00	13.00	NBR	B2U	110.00	130.00	12.00	NBR
		BA	100.00	150.00	12.00	NBR	BAFUDX7	110.00	130.00	12.00	NBR
		BAU	100.00	160.00	14.00	NBR	BAUMSLX7	110.00	130.00	12.00	FPM
		BAUSLX7	100.00	160.00	14.00	NBR	BAUMX7	110.00	130.00	12.00	NBR
		BAU	100.00	180.00	12.00	NBR	B1FUD	110.00	130.00	13.00	NBR
		BAUSLX7	100.00	180.00	12.00	NBR	B1FUDSL	110.00	130.00	13.00	NBR
		B2U	102.00	130.00	13.00	NBR	B2FUD	110.00	130.00	13.00	NBR
		B2U	103.00	125.00	13.00	NBR	B2FUD	110.00	130.00	15.00	NBR
		BA	104.00	125.00	10.00	NBR	B1FUD	110.00	140.00	12.00	NBR
		B2	104.00	130.00	13.00	NBR	BASL	110.00	140.00	12.00	NBR
		B1USL	105.00	120.00	8.00	NBR	BAU	110.00	140.00	12.00	NBR
		B1U	105.00	125.00	12.00	NBR	BAU	110.00	140.00	12.00	NBR
		B2U	105.00	125.00	13.00	NBR	BAUMX7	110.00	140.00	12.00	FPM
		B1U	105.00	130.00	12.00	NBR	B2FUD	110.00	140.00	13.00	NBR
		BAFUDSLX7	105.00	130.00	12.00	NBR	B2FUDSL	110.00	140.00	13.00	NBR
		BAU	105.00	130.00	12.00	NBR	BAUSL	110.00	140.00	13.00	NBR
		BAUMSLX7	105.00	130.00	12.00	FPM	B2FUD	110.00	140.00	15.00	NBR
		BAUMX7	105.00	130.00	12.00	FPM	B1U	110.00	145.00	15.00	NBR
		B2U	105.00	130.00	13.00	NBR	BAFUDX7	110.00	150.00	12.00	NBR
		B2U	105.00	130.00	15.00	NBR	B2FUD	110.00	150.00	13.00	NBR
		B2	105.00	135.00	13.00	NBR	B2FUD	110.00	150.00	15.00	NBR
		B1U	105.00	140.00	12.00	NBR	BADUO	110.00	150.00	18.00	NBR
		BA	105.00	140.00	12.00	NBR	BAU	110.00	200.00	13.00	NBR
		BAUMX7	105.00	140.00	12.00	FPM	BAUSLX7	110.00	200.00	13.00	NBR
		B1	105.00	140.00	13.00	NBR	B1	112.00	130.00	12.00	NBR
		B2U	105.00	140.00	13.00	NBR	B1SL	112.00	140.00	13.00	NBR
		B2USL	105.00	140.00	13.00	NBR	B2	112.00	140.00	13.00	NBR
		B2	105.00	140.00	15.00	NBR	BAU	112.00	140.00	13.00	NBR
		B1	105.00	145.00	15.00	NBR	B2	112.00	150.00	15.00	NBR
		B2	105.00	150.00	15.00	NBR	B2	113.00	140.00	13.00	NBR
		BAUMSLX7	105.00	160.00	12.00	FPM	B2U	114.00	140.00	13.00	NBR
		BAUSLX2	105.00	160.00	12.00	NBR	B1	115.00	135.00	13.00	NBR
		B2	106.00	130.00	13.00	NBR	B2USL	115.00	140.00	11.00	NBR
		B2	107.00	130.00	13.00	NBR	B1	115.00	140.00	12.00	NBR
		B2U	107.00	140.00	13.00	NBR	B1FUD	115.00	140.00	12.00	NBR
		B2	108.00	130.00	13.00	NBR	BAFUDSLX7	115.00	140.00	12.00	NBR
		B2U	108.00	140.00	13.00	NBR	BAFUDX7	115.00	140.00	12.00	NBR
		BAUMSL	108.00	140.00	15.00	FPM	BAUMX7	115.00	140.00	12.00	FPM
		BAUSLX2	108.00	140.00	15.00	NBR	B1FUD	115.00	140.00	13.00	NBR
		BAUMSL	108.00	170.00	15.00	FPM	B1USL	115.00	140.00	13.00	NBR
		BAUSLX2	108.00	170.00	15.00	NBR	B2FUD	115.00	140.00	13.00	NBR

N.B.: MINIMUM LINE ORDER MAY APPLY

Tel.: (514) 334-2220  
Fax: (514) 333-8329

**SS 135**

[www.sealsonline.com](http://www.sealsonline.com)



## RADIAL SHAFT SEALS - ALL

## SIMRIT AVAILABILITY LIST























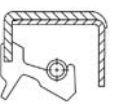

Design Type	Dimensions			Lip Material	Design Type	Dimensions			Lip Material	Diagram	Diagram
	d	D	H			d	D	H			
B1FUDSL	115.00	140.00	15.00	NBR	BAUMSL	120.00	180.00	15.00	FPM		
B2FUD	115.00	140.00	15.00	NBR	BAUSLX2	120.00	180.00	15.00	NBR		
B1U	115.00	150.00	12.00	NBR	BAU	120.00	200.00	14.00	NBR		
BA	115.00	150.00	12.00	NBR	BAUSLX7	120.00	200.00	14.00	NBR		
BAUMSLX7	115.00	150.00	12.00	FPM	B2U	122.00	150.00	13.00	NBR		
BAUMX7	115.00	150.00	12.00	FPM	BASL	122.00	150.00	15.00	NBR		
B1	115.00	150.00	13.00	NBR	BAUSLX2	122.00	200.00	15.00	NBR		
B2U	115.00	150.00	13.00	NBR	B2	124.00	150.00	15.00	NBR		
B2	115.00	150.00	15.00	NBR	B1FUD	125.00	150.00	12.00	NBR		
B2	115.00	160.00	15.00	NBR	B2	125.00	160.00	15.00	NBR		
B2	118.00	140.00	13.00	NBR	BAFUDX7	125.00	150.00	12.00	NBR		
BAUMSL	118.00	150.00	12.00	FPM	BAUMSLX7	125.00	150.00	12.00	FPM		
BAUMSLX7	118.00	150.00	12.00	FPM	B1FUDSL	125.00	150.00	13.00	NBR		
BAUSLX2	118.00	150.00	12.00	NBR	B2FUD	125.00	150.00	13.00	NBR		
BAUX2	118.00	150.00	12.00	NBR	B2FUD	125.00	150.00	15.00	NBR		
B2	118.00	150.00	15.00	NBR	B2USL	125.00	150.00	15.00	NBR		
B2U	118.00	160.00	15.00	NBR	BAUMX7	125.00	150.00	15.00	FPM		
BAU	120.00	140.00	12.00	NBR	B2	125.00	152.40	15.00	NBR		
B1FUD	120.00	140.00	13.00	NBR	B1	125.00	160.00	12.00	NBR		
B1FUDSL	120.00	140.00	13.00	NBR	BA	125.00	160.00	12.00	NBR		
B2FUD	120.00	140.00	13.00	NBR	BAUMX7	125.00	160.00	12.00	FPM		
BAFUDSLX7	120.00	140.00	13.00	NBR	B1	125.00	160.00	13.00	NBR		
BAU	120.00	140.00	13.00	NBR	B2	125.00	160.00	13.00	NBR		
BAUMSLX7	120.00	140.00	13.00	FPM	B2	125.00	160.00	15.00	NBR		
B1U	120.00	145.00	15.00	NBR	BAUMSL	125.00	160.00	15.00	FPM		
B2U	120.00	145.00	15.00	NBR	BAUSLX2	125.00	160.00	15.00	NBR		
B1FUD	120.00	150.00	12.00	NBR	B2	125.00	170.00	13.00	NBR		
BAFUDX7	120.00	150.00	12.00	NBR	B2	125.00	170.00	15.00	NBR		
BAUMSLX7	120.00	150.00	12.00	FPM	BAUMSL	125.00	200.00	15.00	FPM		
BAUMX7	120.00	150.00	12.00	FPM	BAUSLX2	125.00	200.00	15.00	NBR		
B2FUD	120.00	150.00	13.00	NBR	B2FUD	128.00	146.00	13.50	NBR		
BASL	120.00	150.00	13.00	NBR	BAU	128.00	150.00	13.00	NBR		
B1FUD	120.00	150.00	15.00	NBR	B1	128.00	150.00	15.00	NBR		
B2FUD	120.00	150.00	15.00	NBR	B2U	128.00	150.00	15.00	NBR		
B2SL	120.00	150.00	15.00	NBR	B2U	128.00	160.00	15.00	NBR		
B2USL	120.00	150.00	15.00	NBR	B2	129.00	160.00	15.00	NBR		
BAUMSL	120.00	150.00	15.00	FPM	B2U	130.00	155.00	10.00	NBR		
BAUMX7	120.00	150.00	15.00	FPM	B1U	130.00	160.00	12.00	NBR		
BAUSL	120.00	150.00	15.00	NBR	B1USL	130.00	160.00	12.00	NBR		
BAUSLX2	120.00	150.00	15.00	NBR	BAFUDX7	130.00	160.00	12.00	NBR		
B1USL	120.00	160.00	10.00	NBR	BAUMSLX7	130.00	160.00	12.00	FPM		
B1	120.00	160.00	12.00	NBR	BAUMX7	130.00	160.00	12.00	FPM		
BA	120.00	160.00	12.00	NBR	B2U	130.00	160.00	13.00	NBR		
BAUMSLX7	120.00	160.00	12.00	FPM	BAFUDX7	130.00	160.00	13.00	NBR		
BAUMX7	120.00	160.00	12.00	FPM	BAU	130.00	160.00	14.00	NBR		
B2	120.00	160.00	13.00	NBR	B1U	130.00	160.00	15.00	NBR		
B2	120.00	160.00	15.00	NBR	B2FUD	130.00	160.00	15.00	NBR		
B2U	120.00	170.00	15.00	NBR	B2USL	130.00	160.00	15.00	NBR		

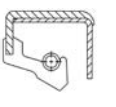
N.B.: MINIMUM LINE ORDER MAY APPLY

## SIMRIT AVAILABILITY LIST

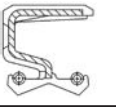
## RADIAL SHAFT SEALS - ALL

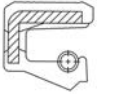
**METRIC SIZE  
SHAFT SEALS**

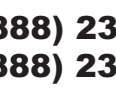
Design Type	Dimensions	Lip Material	Design Type	Dimensions	Lip Material						
						d	D	H	d	D	H
		BAUMX7	130.00	160.00	15.00	FPM	BAUMX7	140.00	170.00	15.00	FPM
		BAUSL	130.00	160.00	15.00	NBR	BAFUDX7	140.00	180.00	12.00	NBR
		B2U	130.00	165.00	13.00	NBR	B1USL	140.00	180.00	15.00	NBR
		BA	130.00	170.00	12.00	NBR	B2	140.00	180.00	15.00	NBR
		BASL	130.00	170.00	12.00	NBR	B2SL	140.00	180.00	15.00	NBR
		BAUMSLX7	130.00	170.00	12.00	FPM	B2	140.00	190.00	15.00	NBR
		BAUMX7	130.00	170.00	12.00	FPM	BAUSLX7	140.00	230.00	15.00	NBR
		B2	130.00	170.00	13.00	NBR	BAU	140.00	250.00	15.00	NBR
		B2	130.00	170.00	15.00	NBR	BAUSLX7	140.00	250.00	15.00	NBR
		B2USL	130.00	170.00	15.00	NBR	B2U	142.00	170.00	15.00	NBR
		B2U	130.00	180.00	15.00	NBR	B2	144.00	180.00	15.00	NBR
		BAUSLX2	130.00	200.00	15.00	NBR	B2FUD	145.00	165.00	13.00	NBR
		BAU	130.00	230.00	14.00	NBR	B1SL	145.00	170.00	13.00	NBR
		BAUSLX7	130.00	230.00	14.00	NBR	B2SL	145.00	170.00	13.00	NBR
		B2	132.00	160.00	13.00	NBR	B2U	145.00	170.00	13.00	NBR
		B2	132.00	160.00	15.00	NBR	B1U	145.00	170.00	15.00	NBR
		BAFUDX7	135.00	160.00	12.00	NBR	B2U	145.00	170.00	15.00	NBR
		B2FUD	135.00	160.00	13.00	NBR	BAU	145.00	170.00	15.00	NBR
		B1FUD	135.00	160.00	15.00	NBR	B2U	145.00	175.00	13.00	NBR
		B2FUD	135.00	160.00	15.00	NBR	B2U	145.00	175.00	13.00	NBR
		B2U	135.00	165.00	13.00	NBR	B1	145.00	175.00	15.00	NBR
		B2	135.00	165.00	15.00	NBR	B1USL	145.00	175.00	15.00	NBR
		B1U	135.00	170.00	12.00	NBR	B2	145.00	175.00	15.00	NBR
		BAFUDX7	135.00	170.00	12.00	NBR	BA	145.00	175.00	15.00	NBR
		BAUMX7	135.00	170.00	12.00	FPM	BAUMX7	145.00	175.00	15.00	FPM
		BAUSL	135.00	170.00	12.00	NBR	B2	145.00	180.00	13.00	NBR
		B2U	135.00	170.00	13.00	NBR	BAUSL	145.00	180.00	13.00	NBR
		B1	135.00	170.00	15.00	NBR	B2U	145.00	180.00	15.00	NBR
		B2U	135.00	170.00	15.00	NBR	B2	145.00	190.00	15.00	NBR
		B2U	135.00	180.00	15.00	NBR	BAUMSLX7	145.00	190.00	17.00	FPM
		B2FUD	138.00	160.00	15.00	NBR	BAUSLX2	145.00	190.00	17.00	NBR
		B2U	138.00	170.00	15.00	NBR	BAUMSLX7	145.00	230.00	17.00	FPM
		B1FUD	140.00	160.00	13.00	NBR	BAUSLX2	145.00	230.00	17.00	NBR
		B2FUD	140.00	160.00	13.00	NBR	B2FUDSL	148.00	170.00	14.50	NBR
		B2FUD	140.00	160.00	13.00	NBR	B2U	148.00	170.00	15.00	NBR
		B2U	140.00	160.00	13.00	NBR	BA	148.00	170.00	15.00	NBR
		BA	140.00	170.00	12.00	NBR	B2U	148.00	180.00	15.00	NBR
		B2FUD	140.00	170.00	15.00	NBR	B2U	150.00	170.00	15.00	NBR
		BAUSLX7	140.00	170.00	13.00	FPM	B2U	150.00	180.00	13.00	NBR
		B1FUD	140.00	170.00	15.00	NBR	BA	150.00	180.00	13.00	NBR
		B2FUD	140.00	170.00	15.00	NBR	B1U	150.00	180.00	15.00	NBR
		B2FUDSL	140.00	170.00	15.00	NBR	B1USL	150.00	180.00	15.00	NBR
		BA	140.00	170.00	15.00	NBR	B2U	150.00	180.00	15.00	NBR
		BASL	140.00	170.00	15.00	NBR	BA	150.00	180.00	15.00	NBR
		BAUMX7	150.00	180.00	15.00	FPM	BAUMX7	150.00	180.00	15.00	FPM
		B2U	150.00	190.00	15.00	NBR	BADUO	150.00	180.00	18.00	NBR
		B2U	150.00	190.00	15.00	NBR	B2U	150.00	190.00	15.00	NBR

N.B.: MINIMUM LINE ORDER MAY APPLY

Tel.: (888) 238-5885  
Fax: (888) 238-1664

**SS 137**













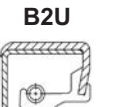
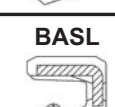



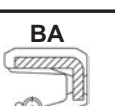

[www.sealsonline.com](http://www.sealsonline.com)

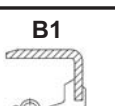

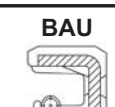
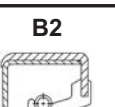
**M**

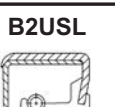
## RADIAL SHAFT SEALS - ALL

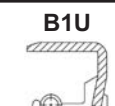
## SIMRIT AVAILABILITY LIST





















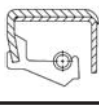

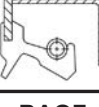
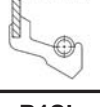
Design Type	Dimensions			Lip Material	Design Type	Dimensions			Lip Material	Diagram	Diagram
	d	D	H			d	D	H			
B2	150.00	200.00	15.00	NBR	BAUMX7	170.00	200.00	15.00	FPM		
BAUSLX2	150.00	225.00	15.00	NBR	B2	170.00	215.00	16.00	NBR		
BA	155.00	174.00	12.00	NBR	B2U	172.00	200.00	15.00	NBR		
B2	155.00	180.00	15.00	NBR	BASL	174.00	190.00	5.00	NBR		
BAUMSLX7	155.00	180.00	15.00	FPM	B2FUD	175.00	200.00	15.00	NBR		
BAUSL	155.00	180.00	15.00	NBR	BA	175.00	205.00	15.00	NBR		
BA	155.00	190.00	13.00	NBR	B2U	175.00	215.00	16.00	NBR		
B1	155.00	190.00	15.00	NBR	B2U	178.00	200.00	15.00	NBR		
B2	155.00	190.00	15.00	NBR	B2	178.00	215.00	16.00	NBR		
B2	155.00	200.00	15.00	NBR	B2U	180.00	200.00	12.00	NBR		
B2U	158.00	180.00	15.00	NBR	B2SL	180.00	200.00	15.00	NBR		
B1USL	160.00	180.00	10.00	NBR	B2U	180.00	200.00	15.00	NBR		
B2FUD	160.00	180.00	15.00	NBR	B1U	180.00	210.00	15.00	NBR		
B1U	160.00	185.00	10.00	NBR	B2U	180.00	210.00	15.00	NBR		
BA	160.00	185.00	10.00	NBR	BAFUDX7	180.00	210.00	15.00	NBR		
BAU	160.00	185.00	14.00	NBR	BAUMX7	180.00	210.00	15.00	FPM		
B1	160.00	190.00	13.00	NBR	B2USL	180.00	215.00	15.00	NBR		
B2	160.00	190.00	13.00	NBR	B1	180.00	215.00	16.00	NBR		
B1	160.00	190.00	15.00	NBR	B2U	180.00	215.00	16.00	NBR		
B2U	160.00	190.00	15.00	NBR	B2	180.00	220.00	16.00	NBR		
B2USL	160.00	190.00	15.00	NBR	B2	182.00	215.00	16.00	NBR		
BASL	160.00	190.00	15.00	NBR	BAFUDX7	185.00	210.00	13.00	NBR		
BAU	160.00	190.00	15.00	NBR	B2U	185.00	215.00	15.00	NBR		
BAUMX7	160.00	190.00	15.00	FPM	B2SL	185.00	215.00	16.00	NBR		
B2U	160.00	200.00	15.00	NBR	B2	185.00	230.00	16.00	NBR		
BAUSLX2	160.00	240.00	14.00	NBR	B2	188.00	215.00	16.00	NBR		
BAU	160.00	290.00	18.00	NBR	B1U	190.00	215.00	15.00	NBR		
BAUSLX7	160.00	290.00	18.00	NBR	B2U	190.00	215.00	16.00	NBR		
BA	162.00	190.00	12.00	NBR	BAUSL	190.00	220.00	12.00	NBR		
B2	162.00	190.00	15.00	NBR	B1FUD	190.00	220.00	15.00	NBR		
B1U	165.00	190.00	13.00	NBR	B2FUD	190.00	220.00	15.00	NBR		
B1USL	165.00	190.00	13.00	NBR	BAFUDX7	190.00	220.00	15.00	NBR		
B2U	165.00	190.00	13.00	NBR	BAUMSLX7	190.00	220.00	15.00	FPM		
BA	165.00	190.00	13.00	NBR	BAUMX7	190.00	220.00	15.00	FPM		
B1U	165.00	190.00	15.00	NBR	B1FUD	190.00	220.00	16.00	NBR		
B2U	165.00	190.00	15.00	NBR	BAU	190.00	225.00	16.00	NBR		
B2	165.00	200.00	15.00	NBR	B2	190.00	230.00	16.00	NBR		
B2U	168.00	190.00	15.00	NBR	B2U	195.00	220.00	16.00	NBR		
B2U	168.00	200.00	15.00	NBR	B2	195.00	230.00	15.00	NBR		
B1USL	170.00	190.00	15.00	NBR	B1	200.00	230.00	15.00	NBR		
B2FUD	170.00	190.00	15.00	NBR	B1USL	200.00	230.00	15.00	NBR		
B1SL	170.00	200.00	12.00	NBR	B2SL	200.00	230.00	15.00	NBR		
B2U	170.00	200.00	13.00	NBR	B2U	200.00	230.00	15.00	NBR		
B1U	170.00	200.00	15.00	NBR	BA	200.00	230.00	15.00	NBR		
B2SL	170.00	200.00	15.00	NBR	BAUMX7	200.00	230.00	15.00	FPM		
B2U	170.00	200.00	15.00	NBR	BAUSL	200.00	230.00	15.00	NBR		
BA	170.00	200.00	15.00	NBR	B1U	200.00	230.00	16.00	NBR		
B2USLX7	170.00	200.00	15.00	NBR	B2	200.00	250.00	15.00	NBR		

N.B.: MINIMUM LINE ORDER MAY APPLY

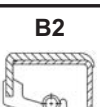
## SIMRIT AVAILABILITY LIST

## RADIAL SHAFT SEALS - ALL

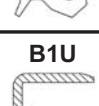
**METRIC SIZE  
SHAFT SEALS**

Design Type	Dimensions	Lip Material	Design Type	Dimensions	Lip Material						
						d	D	H	d	D	H
		B1	205.00	230.00	15.00	NBR	B2	260.00	280.00	16.00	NBR
		B2U	205.00	230.00	16.00	NBR	B2U	260.00	290.00	16.00	NBR
		B2	205.00	250.00	16.00	NBR	B1U	260.00	300.00	20.00	NBR
		B1U	210.00	240.00	15.00	NBR	B2	260.00	300.00	20.00	NBR
		B2	210.00	240.00	15.00	NBR	B2U	260.00	310.00	16.00	NBR
		BA	210.00	240.00	15.00	NBR	B2U	265.00	290.00	16.00	NBR
		BAUMSLX7	210.00	240.00	15.00	FPM	B2	265.00	310.00	16.00	NBR
		B2U	210.00	250.00	16.00	NBR	B1	270.00	310.00	16.00	NBR
		BAUX2	215.00	240.00	12.00	NBR	B2	270.00	310.00	16.00	NBR
		B2U	215.00	250.00	16.00	NBR	B2USL	270.00	310.00	16.00	NBR
		BAU	215.00	250.00	16.00	NBR	B2	275.00	310.00	16.00	NBR
		B2	218.00	250.00	16.00	NBR	B2	280.00	310.00	16.00	NBR
		B1	220.00	250.00	11.00	NBR	B1	280.00	320.00	20.00	NBR
		B1	220.00	250.00	15.00	NBR	B2	280.00	320.00	20.00	NBR
		B2SL	220.00	250.00	15.00	NBR	B2USL	280.00	320.00	20.00	NBR
		B2U	220.00	250.00	15.00	NBR	B2U	285.00	310.00	16.00	NBR
		BA	220.00	250.00	15.00	NBR	BA	285.00	325.00	16.00	NBR
		BAFUDSLX7	220.00	250.00	15.00	NBR	B1USL	290.00	330.00	16.00	NBR
		BAUMSLX7	220.00	250.00	15.00	FPM	B2U	290.00	330.00	18.00	NBR
		BAUMX7	220.00	250.00	15.00	FPM	B2	300.00	332.00	16.00	NBR
		B2	220.00	270.00	15.00	NBR	B2	300.00	335.00	18.00	NBR
		B2	225.00	250.00	16.00	NBR	BA	300.00	340.00	16.00	NBR
		B2	225.00	270.00	16.00	NBR	BAUSLX7	300.00	340.00	16.00	NBR
		BAOF	230.00	250.00	8.00	NBR	B1	300.00	340.00	20.00	NBR
		B1	230.00	255.00	10.00	NBR	B2	300.00	340.00	20.00	NBR
		BA	230.00	255.00	15.00	NBR	B2	310.00	350.00	18.00	NBR
		B1	230.00	260.00	15.00	NBR	B2	315.00	355.00	18.00	NBR
		B2	230.00	260.00	15.00	NBR	B2	315.00	365.00	20.00	NBR
		BA	230.00	260.00	15.00	NBR	B2	320.00	350.00	18.00	NBR
		BASL	230.00	260.00	15.00	NBR	B2	320.00	360.00	18.00	NBR
		BAUMX7	230.00	260.00	15.00	FPM	B1	320.00	360.00	20.00	NBR
		B2	230.00	270.00	15.00	NBR	B2	320.00	360.00	20.00	NBR
		B1U	230.00	270.00	16.00	NBR	B2	325.00	365.00	16.00	NBR
		B2	230.00	280.00	16.00	NBR	B2	330.00	370.00	18.00	NBR
		B2U	235.00	270.00	16.00	NBR	BA	335.00	375.00	18.00	NBR
		B1	240.00	270.00	15.00	NBR	B2	340.00	372.00	16.00	NBR
		B2U	240.00	270.00	15.00	NBR	B2	340.00	380.00	18.00	NBR
		BAU	240.00	270.00	15.00	NBR	B1	340.00	380.00	20.00	NBR
		B2	240.00	280.00	16.00	NBR	B2	340.00	380.00	20.00	NBR
		B2	240.00	290.00	16.00	NBR	B1	350.00	380.00	16.00	NBR
		B2U	245.00	270.00	16.00	NBR	B2	350.00	390.00	18.00	NBR
		B1	250.00	280.00	15.00	NBR	B2	360.00	392.00	20.00	NBR
		B2	250.00	280.00	15.00	NBR	B2	360.00	400.00	18.00	NBR
		BA	250.00	280.00	15.00	NBR	B1	360.00	400.00	20.00	NBR
		B2	250.00	280.00	16.00	NBR	B2	360.00	400.00	20.00	NBR
		B2	250.00	290.00	16.00	NBR	B2	365.00	405.00	18.00	NBR
		BAU	255.00	290.00	12.00	NBR	B1	380.00	420.00	20.00	NBR
		B2U	255.00	290.00	16.00	NBR	B2	380.00	420.00	20.00	NBR

N.B.: MINIMUM LINE ORDER MAY APPLY

Tel.: (204) 783-9617  
Fax: (204) 783-6091

**SS 139**

[www.sealsonline.com](http://www.sealsonline.com)





# GLOBAL AVAILABILITY NBR/STEEL



METRIC SIZE  
SHAFT SEALS

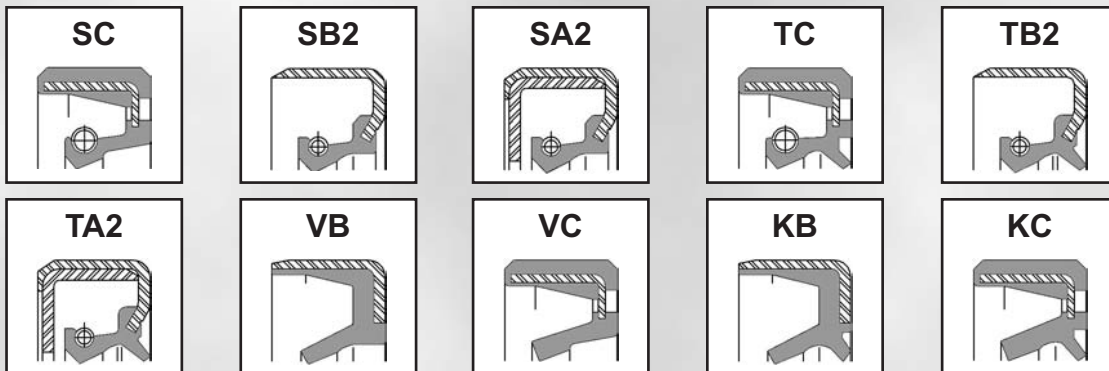











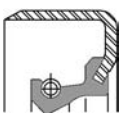

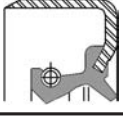

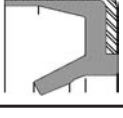
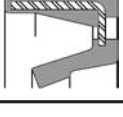

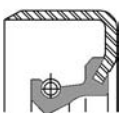

Tel.: (780) 414-1871  
Fax: (780) 487-5419

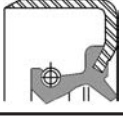
**SS 141**

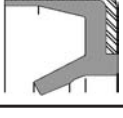
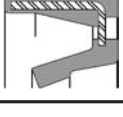
[www.sealsonline.com](http://www.sealsonline.com)

## RADIAL SHAFT SEALS - NBR/STEEL

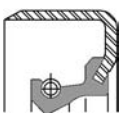
## GLOBAL AVAILABILITY LIST

Ref. Number	Dimensions			DESIGN TYPE										SC 	
	d	D	H	SC	SB2	SA2	TC	TB2	TA2	VB	VC	KB	KC		
S004008020	4.00	8.00	2.00	•	•	•	•	•	•	•	X	X	•	•	SB2 
S004011060	4.00	11.00	6.00	X	•	•	•	•	•	•	•	•	•	•	
S004012060	4.00	12.00	6.00	X	•	•	•	•	•	•	•	•	•	•	SA2 
S005009020	5.00	9.00	2.00	•	•	•	•	•	•	X	X	•	•	•	
S005010020	5.00	10.00	2.00	•	•	•	•	•	•	X	X	•	•	•	
S005015050	5.00	15.00	5.00	•	•	•	X	•	•	•	X	•	•	•	TC 
S005015060	5.00	15.00	6.00	X	•	•	X	•	•	•	•	•	•	•	
S005015070	5.00	15.00	7.00	X	•	•	•	•	•	•	•	•	•	•	TB2 
S005016060	5.00	16.00	6.00	X	X	•	•	•	•	•	•	•	•	•	
S005016070	5.00	16.00	7.00	X	X	•	X	•	•	•	•	•	•	•	TA2 
S005018070	5.00	18.00	7.00	X	•	•	X	•	•	•	•	•	•	•	
S005019050	5.00	19.00	5.00	X	•	•	X	•	•	•	•	•	•	•	VB 
S005022070	5.00	22.00	7.00	•	•	•	X	•	•	•	•	•	•	•	
S005022080	5.00	22.00	8.00	X	•	•	•	•	•	•	•	•	•	•	VC 
S006010020	6.00	10.00	2.00	•	•	•	•	•	•	X	X	•	•	•	
S006011045	6.00	11.00	4.50	•	X	•	•	•	•	•	•	•	•	•	KB 
S006012020	6.00	12.00	2.00	•	•	•	•	•	•	X	X	•	•	•	
S006012030	6.00	12.00	3.00	•	•	•	•	•	•	•	X	•	•	•	KC 
S006013045	6.00	13.00	4.50	X	•	•	•	•	•	X	•	•	•	•	
S006013050	6.00	13.00	5.00	•	X	•	•	•	•	•	•	•	•	•	SC 
S006014060	6.00	14.00	6.00	X	•	•	•	•	•	•	•	•	•	•	
S006015040	6.00	15.00	4.00	X	•	•	•	•	•	•	•	X	•	•	SB2 
S006015060	6.00	15.00	6.00	X	•	•	•	•	•	•	•	•	•	•	
S006016050	6.00	16.00	5.00	X	•	•	X	•	•	•	•	•	•	•	SA2 
S006016060	6.00	16.00	6.00	X	•	•	•	•	•	•	•	•	•	•	
S006016070	6.00	16.00	7.00	X	X	•	X	•	•	•	•	X	•	•	TC 
S006017060	6.00	17.00	6.00	X	•	•	•	•	•	•	•	•	•	•	
S006018050	6.00	18.00	5.00	X	•	•	•	•	•	•	•	•	•	•	TB2 
S006018060	6.00	18.00	6.00	X	•	•	•	•	•	•	•	•	•	•	
S006018070	6.00	18.00	7.00	X	•	•	•	•	•	•	•	•	•	•	TA2 
S006018080	6.00	18.00	8.00	•	•	•	•	•	•	•	•	•	•	•	
S006019060	6.00	19.00	6.00	X	•	•	•	•	•	•	•	•	•	•	VB 
S006019070	6.00	19.00	7.00	X	•	•	X	•	•	•	•	•	•	•	
S006020060	6.00	20.00	6.00	•	•	•	X	•	•	•	•	•	•	•	VC 
S006021080	6.00	21.00	8.00	•	•	•	•	•	•	•	•	X	•	•	
S006022070	6.00	22.00	7.00	X	•	•	X	•	•	•	•	•	•	•	KB 
S006022080	6.00	22.00	8.00	X	•	•	X	•	•	•	•	•	•	•	
S007011020	7.00	11.00	2.00	•	•	•	•	•	•	•	X	X	•	•	KC 
S007014020	7.00	14.00	2.00	•	•	•	•	•	•	•	X	X	•	•	
S007014050	7.00	14.00	5.00	X	•	•	•	•	•	•	•	•	•	•	SC 
S007016070	7.00	16.00	7.00	X	X	•	X	•	•	•	•	•	•	•	
S007017070	7.00	17.00	7.00	•	•	•	•	•	•	•	•	X	•	•	SB2 
S007018070	7.00	18.00	7.00	X	•	•	•	•	•	•	•	•	•	•	
S007018080	7.00	18.00	8.00	•	•	•	X	•	•	•	•	•	•	•	SA2 
S007019060	7.00	19.00	6.00	X	•	•	•	•	•	•	•	•	•	•	
S007022060	7.00	22.00	6.00	X	•	•	•	•	•	•	•	•	•	•	TC 
S007022070	7.00	22.00	7.00	X	•	•	•	•	•	•	•	•	•	•	
S007022080	7.00	22.00	8.00	X	•	•	•	•	•	•	•	•	•	•	











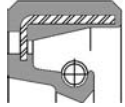





X: EXISTING TOOLING •: ON REQUEST

N.B.: MINIMUM LINE ORDER MAY APPLY

## GLOBAL AVAILABILITY LIST

## RADIAL SHAFT SEALS - NBR/STEEL

METRIC SIZE  
SHAFT SEALS

SC 	Ref. Number	Dimensions			DESIGN TYPE									
		d	D	H	SC	SB2	SA2	TC	TB2	TA2	VB	VC	KB	KC
	S007022100	7.00	22.00	10.00	•	•	•	X	•	•	•	•	•	•
	S007035050	7.00	35.00	5.00	X	•	•	•	•	•	•	•	•	•
	S008012030	8.00	12.00	3.00	•	•	•	•	•	•	X	X	•	•
	S008013035	8.00	13.00	3.50	•	•	•	•	•	•	•	X	•	
	S008014030	8.00	14.00	3.00	•	•	•	•	•	•	X	•	•	
	S008014040	8.00	14.00	4.00	X	•	•	•	•	•	•	X	•	
	S008014060	8.00	14.00	6.00	•	•	•	•	•	•	X	•	•	
	S008015030	8.00	15.00	3.00	•	•	•	•	•	•	X	X	•	
	S008015050	8.00	15.00	5.00	X	X	•	•	•	•	•	•	•	
	S008015070	8.00	15.00	7.00	X	•	•	•	•	•	•	•	•	
	S008015080	8.00	15.00	8.00	X	•	•	•	•	•	•	•	•	
	S008016060	8.00	16.00	6.00	X	•	•	X	•	•	•	•	•	
	S008016070	8.00	16.00	7.00	X	X	•	X	•	•	•	•	•	
	S008018050	8.00	18.00	5.00	X	•	•	X	•	•	•	•	•	
	S008018060	8.00	18.00	6.00	X	•	•	•	•	•	•	•	•	
	S008018070	8.00	18.00	7.00	X	•	•	X	•	•	•	•	•	
	S008019070	8.00	19.00	7.00	•	•	•	X	•	•	•	•	•	
	S008020050	8.00	20.00	5.00	X	•	•	X	•	•	•	•	•	
	S008020070	8.00	20.00	7.00	•	•	•	X	•	•	•	•	•	
	S008020080	8.00	20.00	8.00	X	•	•	•	•	•	•	•	•	
	S008021060	8.00	21.00	6.00	•	•	•	X	•	•	•	•	•	
	S008022060	8.00	22.00	6.00	X	•	•	X	•	•	•	•	•	
	S008022070	8.00	22.00	7.00	X	•	•	X	•	•	•	•	•	
	S008022080	8.00	22.00	8.00	X	X	•	•	•	•	•	•	•	
	S008022100	8.00	22.00	10.00	X	•	•	•	•	•	•	•	•	
	S008024070	8.00	24.00	7.00	X	X	•	•	•	•	•	•	•	
	S008025080	8.00	25.00	8.00	•	•	•	X	•	•	•	•	•	
	S008028070	8.00	28.00	7.00	•	X	•	•	•	•	•	•	•	
	S008030070	8.00	30.00	7.00	X	•	•	•	•	•	•	•	•	
	S009013030	9.00	13.00	3.00	•	•	•	•	•	•	X	X	•	
	S009015030	9.00	15.00	3.00	•	•	•	•	•	•	•	X	•	
	S009016030	9.00	16.00	3.00	•	•	•	•	•	•	•	X	•	
	S009016040	9.00	16.00	4.00	X	•	•	•	•	•	X	•	•	
	S009016050	9.00	16.00	5.00	X	•	•	•	•	•	•	•	•	
	S009017045	9.00	17.00	4.50	•	X	•	•	•	•	•	•	•	
	S009018060	9.00	18.00	6.00	X	•	•	•	•	•	•	•	•	
	S009018070	9.00	18.00	7.00	X	•	•	•	•	•	•	•	•	
	S009018080	9.00	18.00	8.00	•	•	•	X	•	•	•	•	•	
	S009019040	9.00	19.00	4.00	X	•	•	•	•	•	•	•	•	
	S009019050	9.00	19.00	5.00	X	X	•	X	•	•	•	•	•	
	S009019070	9.00	19.00	7.00	X	•	•	•	•	•	•	•	•	
	S009020070	9.00	20.00	7.00	•	•	•	X	•	•	•	•	•	
	S009021095	9.00	21.00	9.50	•	•	•	X	•	•	•	•	•	
	S009022040	9.00	22.00	4.00	•	•	•	•	•	•	•	X	•	
	S009022070	9.00	22.00	7.00	X	X	•	X	•	•	•	•	•	
	S009024070	9.00	24.00	7.00	X	•	•	X	•	•	•	•	•	
	S009026070	9.00	26.00	7.00	X	•	•	•	•	•	•	•	•	
	S009030070	9.00	30.00	7.00	X	•	•	•	•	•	•	•	•	

X: EXISTING TOOLING    •: ON REQUEST

N.B.: MINIMUM LINE ORDER MAY APPLY

Tel.: (604) 278-6808  
Fax: (604) 278-6180

**SS 143**

[www.sealsonline.com](http://www.sealsonline.com)



**M**



## RADIAL SHAFT SEALS - NBR/STEEL

## GLOBAL AVAILABILITY LIST

Ref. Number	Dimensions			DESIGN TYPE										SC 	
	d	D	H	SC	SB2	SA2	TC	TB2	TA2	VB	VC	KB	KC		
S010014030	10.00	14.00	3.00	X	•	•	•	•	•	•	X	X	•	•	
S010015030	10.00	15.00	3.00	X	X	•	•	•	•	•	X	•	•	•	
S010015060	10.00	15.00	6.00	X	•	•	•	•	•	•	•	•	•	•	
S010016040	10.00	16.00	4.00	X	•	•	•	•	•	•	X	X	•	•	
S010016050	10.00	16.00	5.00	X	•	•	•	•	•	•	•	X	•	•	
S010016060	10.00	16.00	6.00	•	X	•	•	•	•	•	•	•	•	•	
S010017030	10.00	17.00	3.00	•	•	•	•	•	•	•	X	X	•	•	
S010017050	10.00	17.00	5.00	•	X	•	•	•	•	•	•	•	•	•	
S010017060	10.00	17.00	6.00	X	•	•	•	•	•	•	•	•	•	•	
S010018040	10.00	18.00	4.00	X	•	•	•	•	•	•	•	•	•	•	
S010018050	10.00	18.00	5.00	X	•	•	•	•	•	•	•	•	•	•	
S010018060	10.00	18.00	6.00	X	X	•	X	•	•	•	•	•	•	•	
S010018090	10.00	18.00	9.00	X	•	•	•	•	•	•	•	•	•	•	
S010019040	10.00	19.00	4.00	X	•	•	•	•	•	•	•	•	•	•	
S010019065	10.00	19.00	6.50	X	•	•	•	•	•	•	•	•	•	•	
S010019070	10.00	19.00	7.00	X	X	•	X	•	•	•	•	•	•	•	
S010019080	10.00	19.00	8.00	X	•	•	•	•	•	•	•	•	•	•	
S010020040	10.00	20.00	4.00	X	•	•	•	•	•	•	•	•	•	•	
S010020050	10.00	20.00	5.00	X	•	•	X	•	•	•	•	•	•	•	
S010020060	10.00	20.00	6.00	X	•	•	X	•	•	•	•	•	•	•	
S010020070	10.00	20.00	7.00	X	•	•	X	•	•	•	•	•	•	•	
S010021050	10.00	21.00	5.00	X	•	•	•	•	•	•	•	•	•	•	
S010022030	10.00	22.00	3.00	•	•	•	•	•	•	•	•	X	•	•	
S010022040	10.00	22.00	4.00	•	•	•	X	•	•	•	•	•	•	•	
S010022050	10.00	22.00	5.00	•	•	•	X	•	•	•	•	•	•	•	
S010022060	10.00	22.00	6.00	X	•	•	X	•	•	•	•	•	•	•	
S010022070	10.00	22.00	7.00	X	•	•	X	•	•	•	•	•	•	•	
S010022080	10.00	22.00	8.00	X	X	X	X	•	•	•	•	•	•	•	
S010024070	10.00	24.00	7.00	X	X	•	X	•	•	•	•	•	•	•	
S010024100	10.00	24.00	10.00	X	•	•	•	•	•	•	•	•	•	•	
S010025045	10.00	25.00	4.50	•	•	•	X	•	•	•	•	•	•	•	
S010025060	10.00	25.00	6.00	X	•	•	•	•	•	•	•	•	•	•	
S010025070	10.00	25.00	7.00	•	•	•	X	•	•	•	•	•	•	•	
S010025080	10.00	25.00	8.00	X	•	•	•	•	•	•	•	•	•	•	
S010026050	10.00	26.00	5.00	•	•	•	•	•	•	•	•	X	•	•	
S010026070	10.00	26.00	7.00	X	X	•	X	•	•	•	•	•	•	•	
S010028070	10.00	28.00	7.00	X	•	•	X	•	•	•	•	•	•	•	
S010028080	10.00	28.00	8.00	X	•	•	•	•	•	•	•	•	•	•	
S010030060	10.00	30.00	6.00	•	•	•	•	•	•	•	•	X	•	•	
S010030070	10.00	30.00	7.00	X	X	•	•	•	•	•	•	•	•	•	
S010030080	10.00	30.00	8.00	X	•	•	•	•	•	•	•	•	•	•	
S010030100	10.00	30.00	10.00	X	X	•	•	•	•	•	•	•	•	•	
S011017040	11.00	17.00	4.00	X	X	•	X	•	•	•	•	•	•	•	
S011018150	11.00	18.00	15.00	•	•	•	•	•	•	•	X	•	•	•	
S011020060	11.00	20.00	6.00	X	•	•	•	•	•	•	•	•	•	•	
S011021080	11.00	21.00	8.00	•	•	•	X	•	•	•	•	•	•	•	
S011022070	11.00	22.00	7.00	X	•	•	X	•	•	•	•	•	•	•	
S011022080	11.00	22.00	8.00	X	•	•	•	•	•	•	•	•	•	•	

X: EXISTING TOOLING •: ON REQUEST









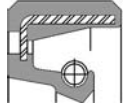

N.B.: MINIMUM LINE ORDER MAY APPLY



## GLOBAL AVAILABILITY LIST

## RADIAL SHAFT SEALS - NBR/STEEL

METRIC SIZE  
SHAFT SEALS

SC 	Ref. Number	Dimensions			DESIGN TYPE									
		d	D	H	SC	SB2	SA2	TC	TB2	TA2	VB	VC	KB	KC
	S011023080	11.00	23.00	8.00	X	•	•	•	•	•	•	•	•	•
	S011026060	11.00	26.00	6.00	X	•	•	•	•	•	•	•	•	•
	S011026070	11.00	26.00	7.00	X	•	•	•	•	•	•	•	•	•
	S011030050	11.00	30.00	5.00	•	•	•	X	•	•	•	•	•	•
	S011030070	11.00	30.00	7.00	X	•	•	X	•	•	•	•	•	•
	S011030080	11.00	30.00	8.00	X	•	•	•	•	•	•	•	•	•
	S011030100	11.00	30.00	10.00	X	•	•	X	•	•	•	•	•	•
	S012016030	12.00	16.00	3.00	•	•	•	•	•	•	X	X	•	•
	S012018030	12.00	18.00	3.00	•	•	•	•	•	•	X	X	•	•
	S012018040	12.00	18.00	4.00	•	X	•	•	•	•	•	X	•	•
	S012018045	12.00	18.00	4.50	X	•	•	X	X	•	•	X	•	•
	S012018050	12.00	18.00	5.00	X	•	•	X	•	•	X	•	•	•
	S012018055	12.00	18.00	5.50	•	•	•	•	•	•	X	X	•	•
	S012019025	12.00	19.00	2.50	•	•	•	•	•	•	X	•	•	•
	S012019030	12.00	19.00	3.00	•	•	•	•	•	•	X	X	•	•
	S012019040	12.00	19.00	4.00	X	•	•	•	•	•	•	•	•	•
	S012019050	12.00	19.00	5.00	X	X	•	X	•	•	•	X	•	•
	S012020040	12.00	20.00	4.00	X	•	•	X	•	•	X	X	•	•
	S012020050	12.00	20.00	5.00	X	X	•	X	X	•	•	X	•	•
	S012020070	12.00	20.00	7.00	X	•	•	•	•	•	•	•	•	•
	S012021040	12.00	21.00	4.00	X	•	•	•	•	•	•	•	•	•
	S012021050	12.00	21.00	5.00	X	•	•	•	X	•	•	•	•	•
	S012022040	12.00	22.00	4.00	X	X	•	•	•	•	•	X	•	•
	S012022045	12.00	22.00	4.50	X	•	•	•	•	•	•	•	•	•
	S012022050	12.00	22.00	5.00	X	•	•	X	•	•	•	•	•	•
	S012022060	12.00	22.00	6.00	X	•	•	X	•	•	X	•	•	•
	S012022065	12.00	22.00	6.50	X	•	•	X	•	•	•	•	•	•
	S012022070	12.00	22.00	7.00	X	X	•	X	•	•	•	•	•	•
	S012022075	12.00	22.00	7.50	•	•	•	X	•	•	•	•	•	•
	S012022080	12.00	22.00	8.00	X	•	•	X	•	•	•	•	•	•
	S012022090	12.00	22.00	9.00	•	•	•	X	•	•	•	•	•	•
	S012023080	12.00	23.00	8.00	•	•	•	X	•	•	•	•	•	•
	S012024045	12.00	24.00	4.50	X	•	•	•	•	•	•	•	•	•
	S012024060	12.00	24.00	6.00	•	•	•	X	•	•	•	•	•	•
	S012024065	12.00	24.00	6.50	X	•	•	•	•	•	•	•	•	•
	S012024070	12.00	24.00	7.00	X	X	•	X	•	•	•	•	•	•
	S012024075	12.00	24.00	7.50	X	•	•	•	•	•	•	•	•	•
	S012024080	12.00	24.00	8.00	X	•	•	X	•	•	•	•	•	•
	S012024100	12.00	24.00	10.00	X	•	•	•	•	•	•	•	•	•
	S012025030	12.00	25.00	3.00	•	•	•	•	•	•	X	•	•	•
	S012025045	12.00	25.00	4.50	X	•	•	X	•	•	•	•	•	•
	S012025050	12.00	25.00	5.00	X	X	•	X	•	•	•	•	•	•
	S012025060	12.00	25.00	6.00	X	•	•	•	•	•	•	•	•	•
	S012025070	12.00	25.00	7.00	X	•	•	X	•	•	•	•	•	•
	S012025080	12.00	25.00	8.00	X	X	•	X	•	•	•	•	•	•
	S012026060	12.00	26.00	6.00	X	•	•	•	•	•	•	•	•	•
	S012026065	12.00	26.00	6.50	X	•	•	•	•	•	•	•	•	•
	S012026070	12.00	26.00	7.00	X	•	•	X	•	•	•	•	•	•

X: EXISTING TOOLING    •: ON REQUEST

N.B.: MINIMUM LINE ORDER MAY APPLY

Tel.: (418) 688-3202  
Fax: (418) 688-4272

**SS 145**

[www.sealsonline.com](http://www.sealsonline.com)



**M**

## RADIAL SHAFT SEALS - NBR/STEEL

## GLOBAL AVAILABILITY LIST

Ref. Number	Dimensions			DESIGN TYPE										SC 
	d	D	H	SC	SB2	SA2	TC	TB2	TA2	VB	VC	KB	KC	
S012026080	12.00	26.00	8.00	X	•	•	X	•	•	•	•	•	•	
S012028050	12.00	28.00	5.00	X	•	•	•	•	•	•	•	•	•	
S012028070	12.00	28.00	7.00	X	X	•	X	X	•	•	•	•	•	
S012028080	12.00	28.00	8.00	X	•	•	X	•	•	•	•	•	•	
S012030050	12.00	30.00	5.00	X	X	•	•	•	•	X	•	•	•	
S012030060	12.00	30.00	6.00	X	•	•	•	•	•	•	•	•	•	
S012030070	12.00	30.00	7.00	X	X	•	X	X	•	•	•	•	•	
S012030090	12.00	30.00	9.00	•	•	•	X	•	•	•	•	•	•	
S012030100	12.00	30.00	10.00	X	•	•	•	•	•	•	•	•	•	
S012032050	12.00	32.00	5.00	X	X	•	•	•	•	•	•	•	•	
S012032070	12.00	32.00	7.00	X	X	•	X	X	•	•	•	•	•	
S012032100	12.00	32.00	10.00	X	•	•	•	•	•	•	•	•	•	
S012034070	12.00	34.00	7.00	•	•	•	X	•	•	•	•	•	•	
S012035043	12.00	35.00	4.30	X	•	•	•	•	•	•	•	•	•	
S012035045	12.00	35.00	4.50	•	•	•	•	•	•	X	X	•	•	
S012035070	12.00	35.00	7.00	X	•	•	•	•	•	•	•	•	•	
S012035100	12.00	35.00	10.00	X	•	•	•	•	•	•	•	•	•	
S012035140	12.00	35.00	14.00	•	•	•	•	•	•	•	X	•	•	
S012037070	12.00	37.00	7.00	•	X	•	•	•	•	•	X	•	•	
S012037100	12.00	37.00	10.00	X	X	•	•	•	•	•	•	•	•	
S012042080	12.00	42.00	8.00	•	•	•	X	•	•	•	•	•	•	
S012045070	12.00	45.00	7.00	X	•	•	•	•	•	•	•	•	•	
S012052070	12.00	52.00	7.00	X	•	•	•	•	•	•	•	•	•	
S013018030	13.00	18.00	3.00	•	•	•	•	•	•	X	X	•	•	
S013019030	13.00	19.00	3.00	X	•	•	•	•	•	X	X	•	•	
S013019050	13.00	19.00	5.00	•	•	•	•	•	•	X	•	•	•	
S013020040	13.00	20.00	4.00	•	X	•	•	•	•	•	•	•	•	
S013022040	13.00	22.00	4.00	X	•	•	•	•	•	•	•	•	•	
S013022050	13.00	22.00	5.00	X	X	•	•	X	•	•	X	•	•	
S013022060	13.00	22.00	6.00	X	•	•	•	•	•	•	•	•	•	
S013023060	13.00	23.00	6.00	X	•	•	•	•	•	•	•	•	•	
S013023065	13.00	23.00	6.50	•	X	•	•	•	•	•	•	•	•	
S013024070	13.00	24.00	7.00	X	•	•	•	•	•	•	•	•	•	
S013025040	13.00	25.00	4.00	X	•	•	•	•	•	•	•	•	•	
S013025050	13.00	25.00	5.00	X	•	•	X	•	•	•	•	•	•	
S013025070	13.00	25.00	7.00	X	X	•	X	•	•	X	•	•	•	
S013026040	13.00	26.00	4.00	•	•	•	•	•	•	•	X	•	•	
S013026050	13.00	26.00	5.00	X	•	•	•	•	•	•	•	•	•	
S013026070	13.00	26.00	7.00	X	•	•	X	•	•	•	•	•	•	
S013026090	13.00	26.00	9.00	X	X	•	X	•	•	•	•	•	•	
S013028070	13.00	28.00	7.00	X	•	•	X	•	•	•	•	•	•	
S013030050	13.00	30.00	5.00	X	•	•	•	•	•	•	•	•	•	
S013030070	13.00	30.00	7.00	X	•	•	•	•	•	•	•	•	•	
S013030080	13.00	30.00	8.00	X	•	•	•	•	•	•	•	•	•	
S013030100	13.00	30.00	10.00	X	•	•	X	•	•	•	•	•	•	
S013032060	13.00	32.00	6.00	X	•	•	•	•	•	•	•	•	•	
S013032070	13.00	32.00	7.00	X	•	•	•	•	•	•	•	•	•	
S013035100	13.00	35.00	10.00	X	•	•	•	•	•	•	•	•	•	

X: EXISTING TOOLING •: ON REQUEST











N.B.: MINIMUM LINE ORDER MAY APPLY

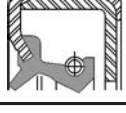

## GLOBAL AVAILABILITY LIST

## RADIAL SHAFT SEALS - NBR/STEEL

METRIC SIZE  
SHAFT SEALS

SC 	Ref. Number	Dimensions			DESIGN TYPE									
		d	D	H	SC	SB2	SA2	TC	TB2	TA2	VB	VC	KB	KC
	S014018030	14.00	18.00	3.00	•	•	•	•	•	•	•	X	•	•
	S014020030	14.00	20.00	3.00	•	•	•	•	•	•	•	X	•	•
	S014020050	14.00	20.00	5.00	X	X	•	•	•	•	•	X	•	•
	S014021030	14.00	21.00	3.00	•	•	•	•	•	•	•	X	•	•
	S014021040	14.00	21.00	4.00	X	•	•	•	•	•	•	•	•	•
	S014022030	14.00	22.00	3.00	•	•	•	•	•	•	•	X	•	•
	S014022040	14.00	22.00	4.00	X	•	•	X	•	•	•	X	•	•
	S014022045	14.00	22.00	4.50	•	•	•	X	•	•	•	•	•	•
	S014022050	14.00	22.00	5.00	X	X	•	X	•	•	•	•	•	•
	S014022060	14.00	22.00	6.00	•	•	•	•	•	•	X	•	•	•
	S014022070	14.00	22.00	7.00	X	•	•	X	•	•	•	•	•	•
	S014023060	14.00	23.00	6.00	X	•	•	•	•	•	•	•	•	•
	S014024040	14.00	24.00	4.00	•	•	•	X	•	•	X	•	•	•
	S014024050	14.00	24.00	5.00	X	X	•	X	•	•	•	X	•	•
	S014024060	14.00	24.00	6.00	X	X	•	•	•	•	•	•	•	•
	S014024070	14.00	24.00	7.00	X	X	•	X	X	•	•	•	•	•
	S014024080	14.00	24.00	8.00	X	•	•	X	•	•	•	•	•	•
	S014025050	14.00	25.00	5.00	X	•	•	•	•	•	•	•	•	•
	S014025060	14.00	25.00	6.00	X	•	•	•	•	•	•	•	•	•
	S014025070	14.00	25.00	7.00	X	X	•	X	•	•	•	•	•	•
	S014025080	14.00	25.00	8.00	X	•	•	•	•	•	•	•	•	•
	S014026060	14.00	26.00	6.00	•	•	•	X	•	•	•	•	•	•
	S014026070	14.00	26.00	7.00	X	X	•	X	•	•	•	•	•	•
	S014027030	14.00	27.00	3.00	•	•	•	•	•	•	•	X	•	•
	S014027070	14.00	27.00	7.00	•	•	•	X	•	•	•	•	•	•
	S014028060	14.00	28.00	6.00	X	•	•	•	•	•	•	•	•	•
	S014028070	14.00	28.00	7.00	X	X	•	X	•	•	•	•	•	•
	S014028080	14.00	28.00	8.00	•	•	•	X	•	•	•	•	•	•
	S014030070	14.00	30.00	7.00	X	•	•	X	•	•	•	•	•	•
	S014030080	14.00	30.00	8.00	X	X	•	X	•	•	•	•	•	•
	S014030100	14.00	30.00	10.00	X	•	•	X	•	•	•	•	•	•
	S014030130	14.00	30.00	13.00	•	•	•	X	•	•	•	•	•	•
	S014032050	14.00	32.00	5.00	X	•	•	•	•	•	•	•	•	•
	S014032070	14.00	32.00	7.00	X	X	•	X	•	•	•	•	•	•
	S014032100	14.00	32.00	10.00	X	•	•	•	•	•	•	•	•	•
	S014034070	14.00	34.00	7.00	X	•	•	•	•	•	•	•	•	•
	S014035045	14.00	35.00	4.50	X	•	•	•	•	•	•	•	•	•
	S014035070	14.00	35.00	7.00	X	•	•	X	•	•	•	•	•	•
	S014035080	14.00	35.00	8.00	X	•	•	•	•	•	•	•	•	•
	S014035100	14.00	35.00	10.00	X	X	•	•	•	•	•	•	•	•
	S014036070	14.00	36.00	7.00	•	•	•	X	•	•	•	•	•	•
	S015021020	15.00	21.00	2.00	•	•	•	•	•	•	X	•	•	•
	S015021030	15.00	21.00	3.00	X	•	•	•	•	•	X	X	•	•
	S015021040	15.00	21.00	4.00	X	•	•	•	•	•	•	X	•	•
	S015021044	15.00	21.00	4.40	X	•	•	•	•	•	•	•	•	•
	S015021045	15.00	21.00	4.50	•	•	•	•	X	•	•	•	•	•
	S015021050	15.00	21.00	5.00	X	•	•	•	•	•	•	X	•	•
	S015022030	15.00	22.00	3.00	•	•	•	•	•	•	X	X	•	•

X: EXISTING TOOLING    •: ON REQUEST

N.B.: MINIMUM LINE ORDER MAY APPLY

Tel.: (514) 334-2220  
Fax: (514) 333-8329

**SS 147**

[www.sealsonline.com](http://www.sealsonline.com)



**M**

## RADIAL SHAFT SEALS - NBR/STEEL

## GLOBAL AVAILABILITY LIST

Ref. Number	Dimensions			DESIGN TYPE										SC 
	d	D	H	SC	SB2	SA2	TC	TB2	TA2	VB	VC	KB	KC	
S015022040	15.00	22.00	4.00	•	•	•	•	•	•	•	X	•	•	
S015022050	15.00	22.00	5.00	•	•	•	X	•	•	•	•	•	•	
S015022070	15.00	22.00	7.00	X	•	•	•	•	•	•	•	•	•	
S015023025	15.00	23.00	2.50	•	•	•	•	•	•	•	X	•	•	
S015023030	15.00	23.00	3.00	X	•	•	•	•	•	X	X	•	•	
S015023050	15.00	23.00	5.00	•	•	•	•	•	•	•	X	•	•	
S015024050	15.00	24.00	5.00	X	•	•	•	•	•	•	•	•	•	
S015024070	15.00	24.00	7.00	X	X	•	X	X	•	•	X	•	•	
S015024090	15.00	24.00	9.00	X	•	•	•	•	•	•	•	•	•	
S015025030	15.00	25.00	3.00	•	•	•	•	•	•	•	X	•	•	
S015025050	15.00	25.00	5.00	X	X	•	X	•	•	•	•	•	•	
S015025060	15.00	25.00	6.00	X	•	•	X	•	•	•	•	•	•	
S015025070	15.00	25.00	7.00	X	X	•	X	•	•	•	•	•	•	
S015025100	15.00	25.00	10.00	•	X	•	•	•	•	•	•	•	•	
S015026045	15.00	26.00	4.50	X	•	•	•	•	•	X	•	•	•	
S015026060	15.00	26.00	6.00	X	•	•	X	•	•	•	•	•	•	
S015026070	15.00	26.00	7.00	X	X	•	X	X	•	•	•	•	•	
S015027070	15.00	27.00	7.00	X	•	•	X	•	•	•	•	•	•	
S015028030	15.00	28.00	3.00	•	•	•	•	•	•	X	•	•	•	
S015028040	15.00	28.00	4.00	X	•	•	•	•	•	•	•	•	•	
S015028060	15.00	28.00	6.00	•	•	•	X	•	•	•	•	•	•	
S015028070	15.00	28.00	7.00	X	X	•	X	•	•	•	•	•	•	
S015028080	15.00	28.00	8.00	X	•	•	•	•	•	•	•	•	•	
S015028090	15.00	28.00	9.00	X	•	•	•	•	•	•	•	•	•	
S015028100	15.00	28.00	10.00	X	•	•	•	•	•	•	•	•	•	
S015030045	15.00	30.00	4.50	X	•	•	•	•	•	•	•	•	•	
S015030050	15.00	30.00	5.00	X	•	•	X	•	•	•	•	•	•	
S015030055	15.00	30.00	5.50	X	•	•	•	•	•	•	•	•	•	
S015030060	15.00	30.00	6.00	X	•	•	•	•	•	•	•	•	•	
S015030070	15.00	30.00	7.00	X	X	•	X	X	•	•	•	•	•	
S015030080	15.00	30.00	8.00	X	X	•	X	•	•	•	•	•	•	
S015030100	15.00	30.00	10.00	X	X	X	X	•	X	•	•	•	•	
S015030120	15.00	30.00	12.00	•	•	•	X	•	•	•	•	•	•	
S015032050	15.00	32.00	5.00	X	•	•	X	•	•	•	•	•	•	
S015032055	15.00	32.00	5.50	X	•	•	•	•	•	X	•	•	•	
S015032070	15.00	32.00	7.00	X	X	•	X	•	•	•	•	•	•	
S015032080	15.00	32.00	8.00	X	•	•	X	•	•	•	•	•	•	
S015032090	15.00	32.00	9.00	X	•	•	X	•	•	•	•	•	•	
S015032100	15.00	32.00	10.00	X	•	•	•	•	•	•	•	•	•	
S015033070	15.00	33.00	7.00	X	•	•	•	•	•	•	•	•	•	
S015033100	15.00	33.00	10.00	•	•	•	X	•	•	•	•	•	•	
S015035050	15.00	35.00	5.00	X	•	•	•	•	•	•	•	•	•	
S015035060	15.00	35.00	6.00	•	•	•	X	•	•	•	•	•	•	
S015035070	15.00	35.00	7.00	X	X	•	X	X	•	•	•	•	•	
S015035080	15.00	35.00	8.00	X	•	•	X	•	•	•	•	•	•	
S015035100	15.00	35.00	10.00	X	X	•	X	•	•	•	•	•	•	
S015036070	15.00	36.00	7.00	•	•	•	X	•	•	•	•	•	•	
S015037060	15.00	37.00	6.00	•	•	•	X	•	•	•	•	•	•	

X: EXISTING TOOLING •: ON REQUEST









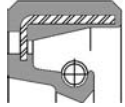

N.B.: MINIMUM LINE ORDER MAY APPLY



## GLOBAL AVAILABILITY LIST

## RADIAL SHAFT SEALS - NBR/STEEL

METRIC SIZE  
SHAFT SEALS

SC 	Ref. Number	Dimensions			DESIGN TYPE									
		d	D	H	SC	SB2	SA2	TC	TB2	TA2	VB	VC	KB	KC
	S015037070	15.00	37.00	7.00	X	•	•	X	•	•	•	•	•	•
	S015037100	15.00	37.00	10.00	X	X	•	•	•	•	•	•	•	•
	S015040080	15.00	40.00	8.00	•	•	•	X	•	•	•	•	•	•
	S015040100	15.00	40.00	10.00	X	X	•	X	•	•	•	•	•	•
	S015042070	15.00	42.00	7.00	X	•	•	X	•	•	•	•	•	•
	S015042080	15.00	42.00	8.00	•	•	•	X	•	•	•	•	•	•
	S015042100	15.00	42.00	10.00	X	•	X	X	•	•	•	•	•	•
	S015048080	15.00	48.00	8.00	•	•	•	X	•	•	•	•	•	•
	S016020025	16.00	20.00	2.50	•	•	•	•	•	•	X	•	•	•
	S016021030	16.00	21.00	3.00	•	•	•	•	•	•	X	•	•	•
	S016022030	16.00	22.00	3.00	X	•	•	•	•	•	X	X	•	•
	S016022040	16.00	22.00	4.00	X	X	•	X	•	•	X	X	•	•
	S016022070	16.00	22.00	7.00	X	•	•	X	•	•	•	•	•	•
	S016023040	16.00	23.00	4.00	•	•	•	•	•	•	•	X	•	•
	S016024030	16.00	24.00	3.00	•	•	•	•	•	•	•	X	•	•
	S016024040	16.00	24.00	4.00	•	X	•	•	•	•	X	X	•	•
	S016024050	16.00	24.00	5.00	X	•	•	•	•	•	•	X	•	•
	S016024060	16.00	24.00	6.00	X	X	•	•	•	•	•	•	•	•
	S016024065	16.00	24.00	6.50	•	•	•	X	•	•	•	•	•	•
	S016024070	16.00	24.00	7.00	X	X	•	•	•	•	X	•	•	•
	S016024075	16.00	24.00	7.50	•	X	•	•	•	•	•	•	•	•
	S016025030	16.00	25.00	3.00	•	•	•	•	•	•	•	X	•	•
	S016025040	16.00	25.00	4.00	•	•	•	•	•	•	X	•	•	•
	S016025070	16.00	25.00	7.00	X	•	•	X	•	•	•	•	•	•
	S016026050	16.00	26.00	5.00	X	•	•	•	•	•	•	•	•	•
	S016026060	16.00	26.00	6.00	X	•	•	•	•	•	•	•	•	•
	S016026070	16.00	26.00	7.00	X	X	•	X	•	•	•	•	•	•
	S016026080	16.00	26.00	8.00	X	•	•	X	•	•	•	•	•	•
	S016028060	16.00	28.00	6.00	X	•	•	•	•	•	•	•	•	•
	S016028070	16.00	28.00	7.00	X	X	•	X	X	•	•	•	•	•
	S016028080	16.00	28.00	8.00	•	•	•	X	•	•	•	•	•	•
	S016029095	16.00	29.00	9.50	X	•	•	•	•	•	•	•	•	•
	S016030045	16.00	30.00	4.50	X	X	•	•	•	•	•	•	•	•
	S016030060	16.00	30.00	6.00	X	X	•	X	•	•	•	•	•	•
	S016030070	16.00	30.00	7.00	X	X	•	X	X	•	•	•	•	•
	S016030080	16.00	30.00	8.00	X	X	•	X	•	•	•	•	•	•
	S016030100	16.00	30.00	10.00	X	X	X	•	•	•	•	•	•	•
	S016032060	16.00	32.00	6.00	X	•	•	•	•	•	•	•	•	•
	S016032070	16.00	32.00	7.00	X	X	•	X	•	•	•	•	•	•
	S016032080	16.00	32.00	8.00	X	•	•	•	•	•	•	•	•	•
	S016032100	16.00	32.00	10.00	X	X	X	•	•	•	•	•	•	•
	S016033080	16.00	33.00	8.00	X	•	•	•	•	•	•	•	•	•
	S016033110	16.00	33.00	11.00	X	•	•	•	•	•	•	•	•	•
	S016034100	16.00	34.00	10.00	•	•	•	X	•	•	•	•	•	•
	S016035060	16.00	35.00	6.00	X	•	•	•	•	•	•	•	•	•
	S016035070	16.00	35.00	7.00	X	X	•	X	•	•	•	•	•	•
	S016035075	16.00	35.00	7.50	•	X	•	•	•	•	•	•	•	•
	S016035080	16.00	35.00	8.00	X	•	•	•	•	•	•	•	•	•

X: EXISTING TOOLING    •: ON REQUEST

N.B.: MINIMUM LINE ORDER MAY APPLY

Tel.: (888) 238-5885  
Fax: (888) 238-1664

**SS 149**

[www.sealsonline.com](http://www.sealsonline.com)



**M**

## RADIAL SHAFT SEALS - NBR/STEEL

## GLOBAL AVAILABILITY LIST

Ref. Number	Dimensions			DESIGN TYPE										SC 
	d	D	H	SC	SB2	SA2	TC	TB2	TA2	VB	VC	KB	KC	
S016035090	16.00	35.00	9.00	•	•	•	X	•	•	•	•	•	•	
S016035100	16.00	35.00	10.00	X	X	X	•	•	•	•	•	•	•	
S016036070	16.00	36.00	7.00	X	•	•	•	•	•	•	•	•	•	
S016038070	16.00	38.00	7.00	X	•	•	•	•	•	•	•	•	•	
S016040050	16.00	40.00	5.00	X	•	•	•	•	•	•	•	•	•	
S016040070	16.00	40.00	7.00	X	•	•	•	•	•	•	•	•	•	
S016040100	16.00	40.00	10.00	X	•	•	X	•	•	•	•	•	•	
S016042060	16.00	42.00	6.00	X	•	•	•	•	•	•	•	•	•	
S016042070	16.00	42.00	7.00	•	•	•	X	•	•	•	•	•	•	
S016048070	16.00	48.00	7.00	•	•	•	X	•	•	•	•	•	•	
S016052070	16.00	52.00	7.00	•	X	•	•	•	•	•	•	•	•	
S017021030	17.00	21.00	3.00	•	•	•	•	•	•	•	X	•	•	
S017022030	17.00	22.00	3.00	•	•	•	•	•	•	X	•	•	•	
S017023030	17.00	23.00	3.00	•	•	•	X	•	•	X	X	•	•	
S017023040	17.00	23.00	4.00	•	•	•	•	•	•	•	X	•	•	
S017023050	17.00	23.00	5.00	•	•	•	•	•	•	•	X	•	•	
S017024040	17.00	24.00	4.00	•	•	•	•	•	•	•	X	•	•	
S017024070	17.00	24.00	7.00	X	•	•	•	•	•	•	X	•	•	
S017025030	17.00	25.00	3.00	•	•	•	•	•	•	•	X	•	•	
S017025040	17.00	25.00	4.00	X	•	•	•	•	•	•	•	•	•	
S017025070	17.00	25.00	7.00	X	•	•	•	•	•	•	•	•	•	
S017026060	17.00	26.00	6.00	X	•	•	•	•	•	•	•	•	•	
S017026070	17.00	26.00	7.00	X	•	•	•	•	•	•	•	•	•	
S017027050	17.00	27.00	5.00	X	•	•	•	•	•	•	•	•	•	
S017027060	17.00	27.00	6.00	X	•	•	•	•	•	•	•	•	•	
S017027070	17.00	27.00	7.00	X	•	•	•	•	•	•	•	•	•	
S017027080	17.00	27.00	8.00	•	•	•	X	•	•	•	•	•	•	
S017027100	17.00	27.00	10.00	X	•	•	X	•	•	•	•	•	•	
S017028050	17.00	28.00	5.00	X	X	•	•	•	•	•	•	•	•	
S017028060	17.00	28.00	6.00	X	X	•	X	•	•	•	•	•	•	
S017028070	17.00	28.00	7.00	X	X	•	X	X	•	•	•	•	•	
S017028080	17.00	28.00	8.00	X	•	•	X	•	•	•	•	•	•	
S017029050	17.00	29.00	5.00	X	•	•	X	•	•	•	•	•	•	
S017029070	17.00	29.00	7.00	•	•	•	X	•	•	•	•	•	•	
S017030050	17.00	30.00	5.00	X	•	•	X	•	•	•	X	•	•	
S017030060	17.00	30.00	6.00	X	•	•	X	•	•	•	•	•	•	
S017030070	17.00	30.00	7.00	X	X	•	X	•	•	•	•	•	•	
S017030080	17.00	30.00	8.00	X	X	•	X	•	•	•	•	•	•	
S017030100	17.00	30.00	10.00	•	X	•	X	•	•	•	•	•	•	
S017031070	17.00	31.00	7.00	X	•	•	X	•	•	•	•	•	•	
S017032050	17.00	32.00	5.00	X	•	•	•	•	•	•	•	•	•	
S017032060	17.00	32.00	6.00	•	•	•	X	•	•	•	•	•	•	
S017032070	17.00	32.00	7.00	X	X	•	X	•	•	•	•	•	•	
S017032075	17.00	32.00	7.50	•	X	•	X	•	•	•	•	•	•	
S017032080	17.00	32.00	8.00	X	•	•	X	•	•	•	•	•	•	
S017032100	17.00	32.00	10.00	X	X	X	•	•	•	•	•	•	•	
S017033070	17.00	33.00	7.00	•	X	•	•	•	•	•	•	•	•	
S017033080	17.00	33.00	8.00	X	•	•	X	•	•	•	•	•	•	

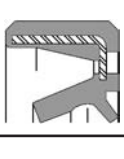

X: EXISTING TOOLING ••: ON REQUEST









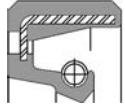

N.B.: MINIMUM LINE ORDER MAY APPLY



## GLOBAL AVAILABILITY LIST

## RADIAL SHAFT SEALS - NBR/STEEL

METRIC SIZE  
SHAFT SEALS

SC 	Ref. Number	Dimensions			DESIGN TYPE									
		d	D	H	SC	SB2	SA2	TC	TB2	TA2	VB	VC	KB	KC
	S017034040	17.00	34.00	4.00	X	X	•	•	•	•	•	•	•	•
	S017034070	17.00	34.00	7.00	X	•	•	X	•	•	•	•	•	•
	S017035050	17.00	35.00	5.00	X	•	•	•	•	•	•	X	•	•
	S017035055	17.00	35.00	5.50	•	X	•	•	•	•	•	•	•	•
	S017035060	17.00	35.00	6.00	X	•	•	•	•	•	•	•	•	•
	S017035070	17.00	35.00	7.00	X	X	•	X	•	•	•	•	•	•
	S017035080	17.00	35.00	8.00	X	X	•	X	•	•	•	•	•	•
	S017035090	17.00	35.00	9.00	•	•	•	X	•	•	•	•	•	•
	S017035095	17.00	35.00	9.50	X	•	•	•	•	•	•	•	•	•
	S017035100	17.00	35.00	10.00	X	X	X	X	•	•	•	•	•	•
	S017037040	17.00	37.00	4.00	X	•	•	•	•	•	•	•	•	•
	S017037050	17.00	37.00	5.00	•	•	•	X	•	•	•	•	•	•
	S017037070	17.00	37.00	7.00	X	•	•	X	•	•	•	•	•	•
	S017037080	17.00	37.00	8.00	X	•	•	•	•	•	•	•	•	•
	S017037100	17.00	37.00	10.00	X	X	•	•	•	•	•	•	•	•
	S017038070	17.00	38.00	7.00	X	•	•	X	•	•	•	•	•	•
	S017038080	17.00	38.00	8.00	X	•	•	•	•	•	•	•	•	•
	S017038110	17.00	38.00	11.00	X	•	•	•	•	•	•	•	•	•
	S017039095	17.00	39.00	9.50	•	•	•	X	•	•	•	•	•	•
	S017040060	17.00	40.00	6.00	X	•	•	•	•	•	•	•	•	•
	S017040070	17.00	40.00	7.00	X	X	•	X	X	•	•	•	•	•
	S017040080	17.00	40.00	8.00	X	•	•	X	•	•	•	•	•	•
	S017040085	17.00	40.00	8.50	X	•	X	•	•	•	•	•	•	•
	S017040100	17.00	40.00	10.00	X	X	X	•	•	•	•	•	•	•
	S017042050	17.00	42.00	5.00	X	•	•	•	•	•	•	•	•	•
	S017042070	17.00	42.00	7.00	X	•	•	•	•	•	•	•	•	•
	S017043070	17.00	43.00	7.00	•	X	•	•	•	•	•	•	•	•
	S017047070	17.00	47.00	7.00	X	X	•	•	•	•	•	•	•	•
	S017047080	17.00	47.00	8.00	X	•	•	X	•	•	•	•	•	•
	S017047100	17.00	47.00	10.00	X	•	•	X	•	•	•	•	•	•
	S017047110	17.00	47.00	11.00	X	•	•	•	•	•	•	•	•	•
	S018024030	18.00	24.00	3.00	•	•	•	•	•	•	X	X	•	•
	S018024040	18.00	24.00	4.00	•	X	•	•	•	•	•	X	•	•
	S018024050	18.00	24.00	5.00	X	•	•	•	•	•	•	•	•	•
	S018025030	18.00	25.00	3.00	•	•	•	•	•	•	•	X	•	•
	S018025040	18.00	25.00	4.00	•	X	•	•	•	•	•	X	•	•
	S018025050	18.00	25.00	5.00	X	•	•	•	•	•	•	•	•	•
	S018025060	18.00	25.00	6.00	•	X	•	•	•	•	•	•	•	•
	S018026040	18.00	26.00	4.00	•	•	•	•	•	•	•	X	•	•
	S018026050	18.00	26.00	5.00	•	•	•	•	•	•	•	X	•	•
	S018026060	18.00	26.00	6.00	X	•	•	•	•	•	•	•	•	•
	S018027040	18.00	27.00	4.00	•	•	•	•	•	•	•	X	•	•
	S018027050	18.00	27.00	5.00	X	•	•	•	•	•	•	X	•	•
	S018028040	18.00	28.00	4.00	X	•	•	•	•	•	•	•	•	•
	S018028050	18.00	28.00	5.00	X	•	•	•	•	•	•	•	•	•
	S018028060	18.00	28.00	6.00	X	•	•	X	•	•	•	•	•	•
	S018028070	18.00	28.00	7.00	X	X	•	X	•	•	•	•	•	•
	S018028080	18.00	28.00	8.00	•	•	•	X	•	•	•	•	•	•

X: EXISTING TOOLING    •: ON REQUEST

N.B.: MINIMUM LINE ORDER MAY APPLY

Tel.: (204) 783-9617  
Fax: (204) 783-6091

**SS 151**

[www.sealsonline.com](http://www.sealsonline.com)



**M**











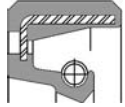



## GLOBAL AVAILABILITY LIST

## RADIAL SHAFT SEALS - NBR/STEEL

METRIC SIZE  
SHAFT SEALS

SC 	Ref. Number	Dimensions			DESIGN TYPE									
		d	D	H	SC	SB2	SA2	TC	TB2	TA2	VB	VC	KB	KC
	S019030090	19.00	30.00	9.00	•	•	•	X	•	•	•	•	•	•
	S019030100	19.00	30.00	10.00	X	•	•	•	•	•	•	•	•	•
	S019031080	19.00	31.00	8.00	•	•	•	X	•	•	•	•	•	•
	S019032050	19.00	32.00	5.00	X	•	•	X	•	•	•	•	•	•
	S019032060	19.00	32.00	6.00	X	•	•	•	•	•	•	•	•	•
	S019032070	19.00	32.00	7.00	X	X	•	X	•	•	•	•	•	•
	S019032080	19.00	32.00	8.00	•	•	•	X	•	•	•	X	•	•
	S019032100	19.00	32.00	10.00	X	•	•	•	•	•	•	•	•	•
	S019034060	19.00	34.00	6.00	X	•	•	•	•	•	•	•	•	•
	S019035070	19.00	35.00	7.00	X	•	•	X	•	•	•	•	•	•
	S019035080	19.00	35.00	8.00	X	•	•	X	•	•	•	•	•	•
	S019035090	19.00	35.00	9.00	•	•	•	X	•	•	•	•	•	•
	S019035100	19.00	35.00	10.00	X	•	•	•	•	•	•	•	•	•
	S019036070	19.00	36.00	7.00	X	•	•	•	•	•	•	•	•	•
	S019036080	19.00	36.00	8.00	X	•	•	•	•	•	•	•	•	•
	S019037100	19.00	37.00	10.00	X	X	•	•	•	•	•	•	•	•
	S019038070	19.00	38.00	7.00	•	•	•	X	•	•	•	•	•	•
	S019038095	19.00	38.00	9.50	X	•	•	•	•	•	•	•	•	•
	S019038100	19.00	38.00	10.00	X	•	•	X	•	•	•	•	•	•
	S019040050	19.00	40.00	5.00	•	•	•	•	•	•	X	•	•	•
	S019040100	19.00	40.00	10.00	X	•	•	X	•	•	•	•	•	•
	S019047070	19.00	47.00	7.00	•	•	•	X	•	•	•	•	•	•
	S019047080	19.00	47.00	8.00	•	•	•	X	•	•	•	•	•	•
	S019047100	19.00	47.00	10.00	X	•	X	X	•	•	•	•	•	•
	S019047105	19.00	47.00	10.50	•	•	•	X	•	•	•	•	•	•
	S019053075	19.00	53.00	7.50	X	•	•	•	•	•	•	•	•	•
	S020024025	20.00	24.00	2.50	X	•	•	•	•	•	X	X	•	•
	S020026040	20.00	26.00	4.00	•	X	•	•	•	•	X	X	•	•
	S020026050	20.00	26.00	5.00	•	•	•	X	•	•	•	•	•	•
	S020026100	20.00	26.00	10.00	X	•	•	•	•	•	•	X	•	•
	S020028035	20.00	28.00	3.50	•	•	•	•	•	•	•	X	•	•
	S020028040	20.00	28.00	4.00	•	•	•	X	•	•	X	X	•	•
	S020028045	20.00	28.00	4.50	X	•	•	•	•	•	•	X	•	•
	S020028050	20.00	28.00	5.00	X	•	•	•	•	•	•	•	•	•
	S020028060	20.00	28.00	6.00	X	•	•	•	X	•	•	•	•	•
	S020028070	20.00	28.00	7.00	X	•	•	X	•	•	•	•	•	•
	S020028100	20.00	28.00	10.00	•	•	•	•	•	•	•	X	•	•
	S020029095	20.00	29.00	9.50	•	•	•	•	X	•	•	•	•	•
	S020030040	20.00	30.00	4.00	•	•	•	•	•	•	X	•	•	•
	S020030045	20.00	30.00	4.50	X	X	•	X	•	•	•	•	•	•
	S020030046	20.00	30.00	4.60	X	•	•	•	•	•	•	•	•	•
	S020030050	20.00	30.00	5.00	X	X	•	X	•	•	•	X	•	•
	S020030060	20.00	30.00	6.00	X	•	•	X	•	•	•	•	•	•
	S020030070	20.00	30.00	7.00	X	X	•	X	X	•	•	•	•	•
	S020030080	20.00	30.00	8.00	X	•	•	X	•	•	•	•	•	•
	S020030090	20.00	30.00	9.00	X	X	•	•	•	•	•	•	•	•
	S020030100	20.00	30.00	10.00	X	•	•	•	•	•	•	•	•	•
	S020031070	20.00	31.00	7.00	X	X	•	X	•	•	•	•	•	•

X: EXISTING TOOLING    •: ON REQUEST

N.B.: MINIMUM LINE ORDER MAY APPLY

Tel.: (780) 414-1871  
Fax: (780) 487-5419

**SS 153**

[www.sealsonline.com](http://www.sealsonline.com)



**M**

## RADIAL SHAFT SEALS - NBR/STEEL

## GLOBAL AVAILABILITY LIST

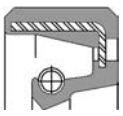
Ref. Number	Dimensions			DESIGN TYPE										SC 
	d	D	H	SC	SB2	SA2	TC	TB2	TA2	VB	VC	KB	KC	
S020032040	20.00	32.00	4.00	•	•	•	•	•	•	•	X	•	•	
S020032050	20.00	32.00	5.00	X	•	•	X	•	•	X	X	•	•	
S020032060	20.00	32.00	6.00	X	•	•	X	•	•	•	•	•	•	
S020032065	20.00	32.00	6.50	•	•	•	X	•	•	•	•	•	•	
S020032070	20.00	32.00	7.00	X	X	•	X	X	•	•	X	•	•	
S020032075	20.00	32.00	7.50	•	•	•	X	•	•	•	•	•	•	
S020032080	20.00	32.00	8.00	•	•	•	X	•	•	•	•	•	•	
S020032085	20.00	32.00	8.50	•	X	•	•	•	•	•	•	•	•	
S020032120	20.00	32.00	12.00	•	•	•	X	•	•	•	•	•	•	
S020033080	20.00	33.00	8.00	X	•	•	•	•	•	•	•	•	•	
S020033090	20.00	33.00	9.00	X	•	•	•	•	•	•	•	•	•	
S020033100	20.00	33.00	10.00	X	X	•	•	•	•	•	•	•	•	
S020034060	20.00	34.00	6.00	X	•	•	•	•	•	•	•	•	•	
S020034070	20.00	34.00	7.00	X	•	•	X	•	•	•	•	•	•	
S020034080	20.00	34.00	8.00	•	•	•	X	•	•	•	•	•	•	
S020035045	20.00	35.00	4.50	•	•	•	•	X	•	•	•	•	•	
S020035050	20.00	35.00	5.00	X	•	•	X	•	•	•	X	•	•	
S020035055	20.00	35.00	5.50	X	•	•	X	•	•	•	•	•	•	
S020035060	20.00	35.00	6.00	X	•	•	X	•	•	•	X	•	•	
S020035070	20.00	35.00	7.00	X	X	•	X	X	•	•	•	•	•	
S020035080	20.00	35.00	8.00	X	X	•	X	•	•	•	•	•	•	
S020035100	20.00	35.00	10.00	X	X	X	X	X	•	•	•	•	•	
S020035120	20.00	35.00	12.00	X	•	•	X	•	•	•	•	•	•	
S020035130	20.00	35.00	13.00	•	•	•	X	•	•	•	•	•	•	
S020036050	20.00	36.00	5.00	X	•	•	•	•	•	•	•	•	•	
S020036060	20.00	36.00	6.00	X	•	•	•	•	•	•	•	•	•	
S020036070	20.00	36.00	7.00	X	•	•	X	•	•	•	•	•	•	
S020037060	20.00	37.00	6.00	•	X	•	•	•	•	•	•	•	•	
S020037065	20.00	37.00	6.50	•	X	•	•	•	•	•	•	•	•	
S020037070	20.00	37.00	7.00	X	X	•	X	•	•	•	•	•	•	
S020037080	20.00	37.00	8.00	X	•	•	X	•	•	•	•	•	•	
S020037100	20.00	37.00	10.00	X	•	•	X	•	•	•	•	•	•	
S020038030	20.00	38.00	3.00	•	•	•	X	•	•	•	•	•	•	
S020038050	20.00	38.00	5.00	X	•	•	X	•	•	•	•	•	•	
S020038060	20.00	38.00	6.00	X	•	•	•	•	•	•	•	•	•	
S020038070	20.00	38.00	7.00	X	•	•	X	•	•	•	•	•	•	
S020038080	20.00	38.00	8.00	X	•	X	X	•	•	•	•	•	•	
S020038090	20.00	38.00	9.00	X	•	•	•	•	•	•	•	•	•	
S020038100	20.00	38.00	10.00	•	•	•	X	•	•	•	•	•	•	
S020040050	20.00	40.00	5.00	X	•	•	•	•	•	•	•	•	•	
S020040060	20.00	40.00	6.00	X	•	•	X	•	•	•	•	•	•	
S020040070	20.00	40.00	7.00	X	X	•	X	X	•	•	•	•	•	
S020040080	20.00	40.00	8.00	•	•	•	X	•	•	•	•	•	•	
S020040085	20.00	40.00	8.50	X	•	•	•	•	•	•	•	•	•	
S020040090	20.00	40.00	9.00	X	•	•	X	•	•	•	•	•	•	
S020040100	20.00	40.00	10.00	X	X	X	X	X	•	•	•	•	•	
S020040110	20.00	40.00	11.00	X	•	•	X	•	•	•	•	•	•	
S020041080	20.00	41.00	8.00	X	•	•	•	•	•	•	•	•	•	

X: EXISTING TOOLING •: ON REQUEST



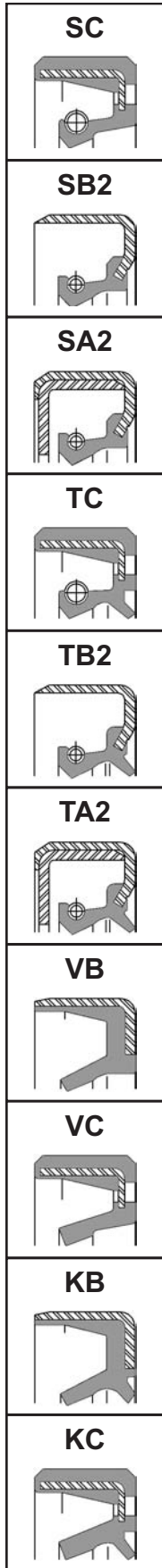





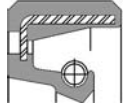

N.B.: MINIMUM LINE ORDER MAY APPLY



## GLOBAL AVAILABILITY LIST

## RADIAL SHAFT SEALS - NBR/STEEL

METRIC SIZE  
SHAFT SEALS

SC 	Ref. Number	Dimensions			DESIGN TYPE									
		d	D	H	SC	SB2	SA2	TC	TB2	TA2	VB	VC	KB	KC
	S020042060	20.00	42.00	6.00	•	•	•	X	•	•	•	X	•	•
	S020042070	20.00	42.00	7.00	X	X	X	X	X	•	•	•	•	•
	S020042080	20.00	42.00	8.00	•	•	•	X	•	•	•	•	•	•
	S020042100	20.00	42.00	10.00	X	X	X	X	•	•	•	•	•	•
	S020042120	20.00	42.00	12.00	•	•	•	X	•	•	•	•	•	•
	S020043075	20.00	43.00	7.50	X	•	•	•	•	•	•	•	•	•
	S020045070	20.00	45.00	7.00	•	•	•	X	•	•	•	•	•	•
	S020045080	20.00	45.00	8.00	•	•	•	X	•	•	•	•	•	•
	S020045100	20.00	45.00	10.00	X	•	•	•	•	•	•	•	•	•
	S020045120	20.00	45.00	12.00	X	•	•	•	•	•	•	•	•	•
	S020046060	20.00	46.00	6.00	X	•	•	•	•	•	•	•	•	•
	S020046080	20.00	46.00	8.00	•	•	•	X	•	•	•	•	•	•
	S020047050	20.00	47.00	5.00	•	•	•	X	•	•	•	•	•	•
	S020047070	20.00	47.00	7.00	X	X	X	X	•	•	•	•	•	•
	S020047080	20.00	47.00	8.00	X	•	•	X	•	•	•	•	•	•
	S020047085	20.00	47.00	8.50	X	•	•	•	•	•	•	•	•	•
	S020047090	20.00	47.00	9.00	X	•	•	X	•	•	•	•	•	•
	S020047095	20.00	47.00	9.50	X	•	•	•	•	•	•	•	•	•
	S020047100	20.00	47.00	10.00	X	X	X	X	X	•	•	•	•	•
	S020047120	20.00	47.00	12.00	•	•	•	X	•	•	•	•	•	•
	S020048090	20.00	48.00	9.00	X	•	•	•	•	•	•	•	•	•
	S020050120	20.00	50.00	12.00	•	•	X	•	•	•	•	•	•	•
	S020052070	20.00	52.00	7.00	X	X	•	X	•	•	•	•	•	•
	S020052080	20.00	52.00	8.00	X	•	•	X	•	•	•	•	•	•
	S020052090	20.00	52.00	9.00	•	•	•	X	•	•	•	•	•	•
	S020052100	20.00	52.00	10.00	X	X	X	X	•	•	•	•	•	•
	S020052120	20.00	52.00	12.00	X	•	•	•	•	•	•	•	•	•
	S020054070	20.00	54.00	7.00	•	•	•	X	•	•	•	•	•	•
	S020057080	20.00	57.00	8.00	X	•	•	•	•	•	•	•	•	•
	S020060100	20.00	60.00	10.00	X	•	•	•	•	•	•	•	•	•
	S020062065	20.00	62.00	6.50	X	•	•	•	•	•	•	•	•	•
	S020062100	20.00	62.00	10.00	•	•	•	X	•	•	•	•	•	•
	S020072050	20.00	72.00	5.00	X	•	•	•	•	•	•	•	•	•
	S020072100	20.00	72.00	10.00	X	•	•	•	•	•	•	•	•	•
	S021025100	21.00	25.00	10.00	•	•	X	•	•	•	•	•	•	•
	S021027030	21.00	27.00	3.00	•	•	•	•	•	•	•	X	•	•
	S021028040	21.00	28.00	4.00	X	•	•	•	•	•	•	•	•	•
	S021028050	21.00	28.00	5.00	•	•	•	•	•	•	X	•	•	•
	S021028055	21.00	28.00	5.50	•	•	•	•	•	•	X	•	•	•
	S021029040	21.00	29.00	4.00	•	•	•	•	•	•	•	X	•	•
	S021030065	21.00	30.00	6.50	X	X	•	•	•	•	•	•	•	•
	S021031050	21.00	31.00	5.00	•	•	•	X	•	•	•	•	•	•
	S021032050	21.00	32.00	5.00	X	X	•	•	•	•	•	•	•	•
	S021032070	21.00	32.00	7.00	X	•	•	•	•	•	•	•	•	•
	S021032080	21.00	32.00	8.00	•	•	•	X	•	•	•	•	•	•
	S021033070	21.00	33.00	7.00	•	•	•	•	•	•	•	X	•	•
	S021034070	21.00	34.00	7.00	•	X	•	•	•	•	•	•	•	•
	S021035060	21.00	35.00	6.00	X	•	•	•	•	•	•	•	•	•

X: EXISTING TOOLING    •: ON REQUEST

N.B.: MINIMUM LINE ORDER MAY APPLY

Tel.: (604) 278-6808  
Fax: (604) 278-6180

**SS 155**

[www.sealsonline.com](http://www.sealsonline.com)



**M**

## RADIAL SHAFT SEALS - NBR/STEEL

## GLOBAL AVAILABILITY LIST

Ref. Number	Dimensions			DESIGN TYPE										SC 
	d	D	H	SC	SB2	SA2	TC	TB2	TA2	VB	VC	KB	KC	
S021035070	21.00	35.00	7.00	X	•	•	X	•	•	•	•	•	•	
S021035080	21.00	35.00	8.00	X	•	•	•	•	•	•	•	•	•	
S021035100	21.00	35.00	10.00	X	•	•	•	•	•	•	•	•	•	
S021035130	21.00	35.00	13.00	•	•	•	X	•	•	•	•	•	•	
S021037060	21.00	37.00	6.00	•	•	•	•	•	•	X	•	•	•	
S021037070	21.00	37.00	7.00	X	•	•	•	•	•	•	•	•	•	
S021040050	21.00	40.00	5.00	X	•	•	•	•	•	•	•	•	•	
S021040070	21.00	40.00	7.00	•	•	•	X	•	•	•	•	•	•	
S021040100	21.00	40.00	10.00	X	•	•	•	•	•	•	•	•	•	
S021048080	21.00	48.00	8.00	X	•	•	•	•	•	•	•	•	•	
S021052080	21.00	52.00	8.00	X	•	•	•	•	•	•	•	•	•	
S022028040	22.00	28.00	4.00	•	•	•	•	•	•	X	X	•	•	
S022028045	22.00	28.00	4.50	•	•	•	•	•	•	•	X	•	•	
S022028050	22.00	28.00	5.00	•	•	•	•	•	•	•	X	•	•	
S022029040	22.00	29.00	4.00	•	•	•	•	•	•	•	X	•	•	
S022030040	22.00	30.00	4.00	•	•	•	•	•	•	X	X	•	•	
S022030050	22.00	30.00	5.00	•	•	•	•	•	•	•	X	•	•	
S022030070	22.00	30.00	7.00	X	X	•	X	•	•	•	•	•	•	
S022030080	22.00	30.00	8.00	•	•	•	X	•	•	•	•	•	•	
S022030100	22.00	30.00	10.00	X	•	•	•	•	•	•	X	•	•	
S022031050	22.00	31.00	5.00	X	•	•	•	•	•	•	•	•	•	
S022032040	22.00	32.00	4.00	X	•	•	•	•	•	•	•	•	•	
S022032045	22.00	32.00	4.50	•	•	•	•	•	•	•	X	•	•	
S022032050	22.00	32.00	5.00	X	•	•	•	•	•	•	•	•	•	
S022032055	22.00	32.00	5.50	X	•	•	•	•	•	•	•	•	•	
S022032060	22.00	32.00	6.00	•	X	•	•	•	•	•	•	•	•	
S022032070	22.00	32.00	7.00	X	X	•	X	X	•	•	•	•	•	
S022032080	22.00	32.00	8.00	•	•	•	X	•	•	•	•	•	•	
S022032100	22.00	32.00	10.00	X	•	•	•	•	•	•	•	•	•	
S022033065	22.00	33.00	6.50	•	•	•	X	•	•	•	•	•	•	
S022033070	22.00	33.00	7.00	X	•	•	•	•	•	•	•	•	•	
S022034070	22.00	34.00	7.00	X	•	•	•	•	•	•	•	•	•	
S022035050	22.00	35.00	5.00	•	•	•	X	•	•	•	•	•	•	
S022035055	22.00	35.00	5.50	X	•	•	•	•	•	•	•	•	•	
S022035056	22.00	35.00	5.60	X	•	•	•	•	•	•	•	•	•	
S022035060	22.00	35.00	6.00	X	•	•	X	•	•	•	•	•	•	
S022035065	22.00	35.00	6.50	X	•	•	•	•	•	•	•	•	•	
S022035070	22.00	35.00	7.00	X	X	•	X	X	•	•	•	•	•	
S022035080	22.00	35.00	8.00	X	X	X	X	•	•	•	•	•	•	
S022035100	22.00	35.00	10.00	X	X	•	X	X	•	•	•	•	•	
S022036060	22.00	36.00	6.00	X	•	•	•	•	•	•	•	•	•	
S022036070	22.00	36.00	7.00	X	•	•	•	•	•	•	•	•	•	
S022036080	22.00	36.00	8.00	•	•	•	X	•	•	•	•	•	•	
S022036090	22.00	36.00	9.00	•	•	•	•	X	•	•	•	•	•	
S022036100	22.00	36.00	10.00	•	•	•	X	•	•	•	•	•	•	
S022037070	22.00	37.00	7.00	X	X	•	X	•	•	•	•	•	•	
S022037080	22.00	37.00	8.00	•	•	•	X	•	•	•	•	•	•	
S022037085	22.00	37.00	8.50	•	•	•	X	•	•	•	•	•	•	

X: EXISTING TOOLING •: ON REQUEST

N.B.: MINIMUM LINE ORDER MAY APPLY



## GLOBAL AVAILABILITY LIST

## RADIAL SHAFT SEALS - NBR/STEEL

**METRIC SIZE  
SHAFT SEALS**

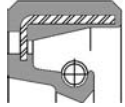
SC 	Ref. Number	Dimensions			DESIGN TYPE									
		d	D	H	SC	SB2	SA2	TC	TB2	TA2	VB	VC	KB	KC
	S022038060	22.00	38.00	6.00	X	•	•	X	•	•	•	•	•	•
	S022038070	22.00	38.00	7.00	X	•	•	X	•	•	•	•	•	•
	S022038080	22.00	38.00	8.00	X	•	•	X	•	•	•	•	•	•
	S022040050	22.00	40.00	5.00	•	•	•	X	•	•	•	•	•	•
	S022040070	22.00	40.00	7.00	X	X	•	X	X	•	•	•	•	•
	S022040080	22.00	40.00	8.00	X	X	•	X	•	•	•	•	•	•
	S022040085	22.00	40.00	8.50	X	X	•	•	•	•	•	•	•	•
	S022040090	22.00	40.00	9.00	•	•	X	X	•	•	•	•	•	•
	S022040100	22.00	40.00	10.00	X	X	X	X	•	•	•	•	•	•
	S022040110	22.00	40.00	11.00	•	•	•	X	•	•	•	•	•	•
	S022040160	22.00	40.00	16.00	•	•	•	X	•	•	•	•	•	•
	S022041090	22.00	41.00	9.00	X	•	•	•	•	•	•	•	•	•
	S022042050	22.00	42.00	5.00	X	•	•	•	•	•	•	•	•	•
	S022042070	22.00	42.00	7.00	X	•	•	X	•	•	•	•	•	•
	S022042080	22.00	42.00	8.00	•	•	•	X	•	•	•	•	•	•
	S022042100	22.00	42.00	10.00	X	X	X	X	X	•	•	•	•	•
	S022042110	22.00	42.00	11.00	X	•	•	X	•	X	•	•	•	•
	S022042120	22.00	42.00	12.00	•	•	•	X	•	•	•	•	•	•
	S022043150	22.00	43.00	15.00	•	X	•	•	•	•	•	•	•	•
	S022045070	22.00	45.00	7.00	X	•	•	X	•	•	•	•	•	•
	S022045080	22.00	45.00	8.00	X	X	•	X	•	•	•	•	•	•
	S022045100	22.00	45.00	10.00	X	•	•	•	•	•	•	•	•	•
	S022045110	22.00	45.00	11.00	•	•	•	X	•	•	•	•	•	•
	S022047070	22.00	47.00	7.00	X	X	•	X	•	•	•	•	•	•
	S022047090	22.00	47.00	9.00	•	•	X	•	•	•	•	•	•	•
	S022047100	22.00	47.00	10.00	X	X	X	X	•	•	•	•	•	•
	S022048050	22.00	48.00	5.00	X	•	•	•	•	•	•	•	•	•
	S022048070	22.00	48.00	7.00	•	•	•	X	•	•	•	•	•	•
	S022048100	22.00	48.00	10.00	X	•	•	•	•	•	•	•	•	•
	S022048110	22.00	48.00	11.00	•	•	•	X	•	•	•	•	•	•
	S022050100	22.00	50.00	10.00	X	•	•	•	•	•	•	•	•	•
	S022052100	22.00	52.00	10.00	•	•	•	X	•	•	•	•	•	•
	S022062120	22.00	62.00	12.00	•	•	•	X	•	•	•	•	•	•
	S023028030	23.00	28.00	3.00	•	•	•	•	•	•	X	X	•	•
	S023030040	23.00	30.00	4.00	•	•	•	•	•	•	X	•	•	•
	S023031050	23.00	31.00	5.00	•	•	•	•	•	•	•	X	•	•
	S023032050	23.00	32.00	5.00	•	X	•	X	•	•	X	•	•	•
	S023035060	23.00	35.00	6.00	X	•	•	X	•	•	•	•	•	•
	S023035070	23.00	35.00	7.00	X	•	•	X	•	•	•	•	•	•
	S023036100	23.00	36.00	10.00	X	•	•	•	•	•	•	•	•	•
	S023037060	23.00	37.00	6.00	X	•	•	•	•	•	•	•	•	•
	S023037070	23.00	37.00	7.00	X	•	•	•	•	•	•	•	•	•
	S023038070	23.00	38.00	7.00	X	•	•	X	•	•	•	•	•	•
	S023038080	23.00	38.00	8.00	X	•	•	•	•	•	•	•	•	•
	S023040060	23.00	40.00	6.00	•	•	•	X	•	•	•	•	•	•
	S023040070	23.00	40.00	7.00	•	•	•	X	X	•	•	•	•	•
	S023040080	23.00	40.00	8.00	X	•	•	X	•	•	•	•	•	•
	S023040100	23.00	40.00	10.00	X	X	X	X	•	•	•	•	•	•

X: EXISTING TOOLING    •: ON REQUEST

N.B.: MINIMUM LINE ORDER MAY APPLY

**Tel.: (418) 688-3202**  
**Fax: (418) 688-4272**

**SS 157**

[www.sealsonline.com](http://www.sealsonline.com)



**M**

## RADIAL SHAFT SEALS - NBR/STEEL

## GLOBAL AVAILABILITY LIST

Ref. Number	Dimensions			DESIGN TYPE										SC 
	d	D	H	SC	SB2	SA2	TC	TB2	TA2	VB	VC	KB	KC	
S023042100	23.00	42.00	10.00	X	•	X	X	•	•	•	•	•	•	
S023042110	23.00	42.00	11.00	•	•	•	X	•	•	•	•	•	•	
S023045110	23.00	45.00	11.00	•	•	•	X	•	•	•	•	•	•	
S023047070	23.00	47.00	7.00	•	•	•	X	•	•	•	•	•	•	
S023047100	23.00	47.00	10.00	X	•	•	X	•	•	•	•	•	•	
S023048100	23.00	48.00	10.00	•	•	•	X	•	•	•	•	•	•	
S023052110	23.00	52.00	11.00	•	•	•	X	•	•	•	•	•	•	
S023052120	23.00	52.00	12.00	X	•	•	•	•	•	•	•	•	•	
S023055070	23.00	55.00	7.00	•	•	•	X	•	•	•	•	•	•	
S024030040	24.00	30.00	4.00	•	•	•	•	•	•	X	•	•	•	
S024032040	24.00	32.00	4.00	•	•	•	•	•	•	•	X	•	•	
S024032050	24.00	32.00	5.00	X	•	•	•	•	•	X	•	•	•	
S024032070	24.00	32.00	7.00	•	•	•	•	X	•	•	•	•	•	
S024033040	24.00	33.00	4.00	•	•	•	•	•	•	•	X	•	•	
S024034055	24.00	34.00	5.50	X	•	•	•	•	•	•	•	•	•	
S024035050	24.00	35.00	5.00	•	X	•	•	•	•	•	•	•	•	
S024035060	24.00	35.00	6.00	X	•	•	X	•	•	•	•	•	•	
S024035070	24.00	35.00	7.00	X	X	•	X	•	•	•	•	•	•	
S024035080	24.00	35.00	8.00	•	•	•	X	•	•	•	•	•	•	
S024036050	24.00	36.00	5.00	•	X	•	•	•	•	•	•	•	•	
S024036060	24.00	36.00	6.00	X	X	•	•	•	•	•	•	•	•	
S024036070	24.00	36.00	7.00	X	•	•	X	•	•	•	•	•	•	
S024036090	24.00	36.00	9.00	X	X	•	•	•	•	•	•	•	•	
S024037070	24.00	37.00	7.00	X	X	•	X	•	•	•	•	•	•	
S024037090	24.00	37.00	9.00	•	•	X	•	•	•	•	•	•	•	
S024038070	24.00	38.00	7.00	•	•	•	X	•	•	•	•	•	•	
S024038080	24.00	38.00	8.00	•	•	•	X	•	•	•	•	•	•	
S024038085	24.00	38.00	8.50	•	•	•	X	•	•	•	•	•	•	
S024038100	24.00	38.00	10.00	•	X	•	X	•	•	•	•	•	•	
S024039080	24.00	39.00	8.00	X	•	•	•	•	•	•	•	•	•	
S024040070	24.00	40.00	7.00	X	X	•	X	•	•	•	•	•	•	
S024040080	24.00	40.00	8.00	X	•	•	X	•	•	•	•	•	•	
S024040090	24.00	40.00	9.00	•	•	X	•	•	•	•	•	•	•	
S024040100	24.00	40.00	10.00	X	X	X	X	•	•	•	•	•	•	
S024040110	24.00	40.00	11.00	X	•	•	•	•	•	•	•	•	•	
S024040120	24.00	40.00	12.00	X	•	•	•	•	•	•	•	•	•	
S024041100	24.00	41.00	10.00	•	•	•	X	•	•	•	•	•	•	
S024042070	24.00	42.00	7.00	X	•	•	X	•	•	•	•	•	•	
S024042080	24.00	42.00	8.00	X	•	•	X	•	•	•	•	•	•	
S024042100	24.00	42.00	10.00	X	•	X	X	•	•	•	•	•	•	
S024044060	24.00	44.00	6.00	X	•	•	•	•	•	•	•	•	•	
S024044070	24.00	44.00	7.00	X	•	•	•	•	•	•	•	•	•	
S024045070	24.00	45.00	7.00	•	•	•	X	•	•	•	•	•	•	
S024045080	24.00	45.00	8.00	•	•	•	X	•	•	•	•	•	•	
S024045100	24.00	45.00	10.00	•	•	•	•	X	•	•	•	•	•	
S024046100	24.00	46.00	10.00	•	•	X	X	•	•	•	•	•	•	
S024047070	24.00	47.00	7.00	X	X	•	X	•	•	•	•	•	•	
S024047080	24.00	47.00	8.00	•	•	•	X	•	•	•	•	•	•	

X: EXISTING TOOLING •: ON REQUEST

N.B.: MINIMUM LINE ORDER MAY APPLY



## GLOBAL AVAILABILITY LIST

## RADIAL SHAFT SEALS - NBR/STEEL

METRIC SIZE  
SHAFT SEALS

SC 	Ref. Number	Dimensions			DESIGN TYPE									
		d	D	H	SC	SB2	SA2	TC	TB2	TA2	VB	VC	KB	KC
	S024047100	24.00	47.00	10.00	X	•	X	X	•	•	•	•	•	•
	S024048100	24.00	48.00	10.00	X	•	•	•	•	•	•	•	•	•
	S024048110	24.00	48.00	11.00	•	•	•	•	X	•	•	•	•	•
	S024049120	24.00	49.00	12.00	•	•	•	X	•	•	•	•	•	•
	S024050100	24.00	50.00	10.00	X	•	•	X	•	•	•	•	•	•
	S024051070	24.00	51.00	7.00	•	•	•	X	•	•	•	•	•	•
	S024052070	24.00	52.00	7.00	•	•	•	X	•	•	•	•	•	•
	S024052100	24.00	52.00	10.00	X	•	•	X	•	•	•	•	•	•
	S024052110	24.00	52.00	11.00	•	•	•	X	•	•	•	•	•	•
	S024052120	24.00	52.00	12.00	•	•	X	•	•	•	•	•	•	•
	S024054140	24.00	54.00	14.00	•	•	•	X	•	•	•	•	•	•
	S024062070	24.00	62.00	7.00	X	•	•	•	•	•	•	•	•	•
	S025027030	25.00	27.00	3.00	•	•	•	•	•	•	•	X	•	•
	S025030070	25.00	30.00	7.00	•	•	•	X	•	•	•	•	•	•
	S025031025	25.00	31.00	2.50	•	•	•	•	•	•	X	•	•	•
	S025031040	25.00	31.00	4.00	•	•	•	•	•	•	•	X	•	•
	S025031050	25.00	31.00	5.00	•	•	•	•	•	•	•	X	•	•
	S025032030	25.00	32.00	3.00	•	•	•	•	•	•	X	•	•	•
	S025032040	25.00	32.00	4.00	•	•	•	•	•	•	X	X	•	•
	S025032045	25.00	32.00	4.50	•	•	•	•	•	•	X	•	•	•
	S025032050	25.00	32.00	5.00	•	•	•	•	•	•	X	•	•	•
	S025032060	25.00	32.00	6.00	X	•	•	X	•	•	•	•	•	•
	S025032070	25.00	32.00	7.00	X	X	•	•	X	•	X	•	•	•
	S025033040	25.00	33.00	4.00	X	•	•	•	•	•	X	X	•	•
	S025033060	25.00	33.00	6.00	X	•	•	•	•	•	•	X	•	•
	S025033080	25.00	33.00	8.00	•	•	•	•	•	•	•	X	•	•
	S025034050	25.00	34.00	5.00	•	X	•	•	•	•	•	•	•	•
	S025034070	25.00	34.00	7.00	•	•	•	•	X	•	•	•	•	•
	S025034100	25.00	34.00	10.00	•	X	•	•	•	•	•	•	•	•
	S025035040	25.00	35.00	4.00	•	X	•	•	•	•	•	X	•	•
	S025035050	25.00	35.00	5.00	X	X	•	X	•	•	•	•	•	•
	S025035060	25.00	35.00	6.00	•	X	•	X	X	•	X	X	•	•
	S025035070	25.00	35.00	7.00	X	X	•	X	X	•	•	•	•	•
	S025035080	25.00	35.00	8.00	X	X	•	X	•	•	X	•	•	•
	S025035085	25.00	35.00	8.50	•	•	•	•	X	•	•	•	•	•
	S025035090	25.00	35.00	9.00	X	•	•	•	•	•	•	•	•	•
	S025035100	25.00	35.00	10.00	X	X	•	•	X	•	•	•	•	•
	S025036060	25.00	36.00	6.00	•	•	•	X	•	•	•	•	•	•
	S025036070	25.00	36.00	7.00	X	X	•	X	•	•	•	•	•	•
	S025036080	25.00	36.00	8.00	•	•	•	X	•	•	•	•	•	•
	S025036090	25.00	36.00	9.00	•	•	•	X	•	•	•	•	•	•
	S025036100	25.00	36.00	10.00	X	•	•	•	•	•	•	•	•	•
	S025037050	25.00	37.00	5.00	X	•	•	•	•	•	•	•	•	•
	S025037055	25.00	37.00	5.50	•	•	•	X	•	•	•	•	•	•
	S025037060	25.00	37.00	6.00	X	•	•	X	•	•	•	•	•	•
	S025037070	25.00	37.00	7.00	X	X	•	X	•	•	•	•	•	•
	S025037080	25.00	37.00	8.00	X	•	•	X	•	•	•	•	•	•
	S025038030	25.00	38.00	3.00	•	•	•	•	•	•	X	•	•	•

X: EXISTING TOOLING    •: ON REQUEST

N.B.: MINIMUM LINE ORDER MAY APPLY

Tel.: (514) 334-2220  
Fax: (514) 333-8329

**SS 159**

[www.sealsonline.com](http://www.sealsonline.com)





## RADIAL SHAFT SEALS - NBR/STEEL

## GLOBAL AVAILABILITY LIST

Ref. Number	Dimensions			DESIGN TYPE										SC 
	d	D	H	SC	SB2	SA2	TC	TB2	TA2	VB	VC	KB	KC	
S025038050	25.00	38.00	5.00	X	•	•	X	•	•	•	X	•	•	
S025038060	25.00	38.00	6.00	•	•	•	X	•	•	•	•	•	•	
S025038070	25.00	38.00	7.00	X	X	•	X	X	•	•	•	•	•	
S025038080	25.00	38.00	8.00	X	•	•	X	•	•	•	•	•	•	
S025038100	25.00	38.00	10.00	X	•	•	X	•	•	•	•	•	•	
S025039070	25.00	39.00	7.00	•	•	•	X	•	•	•	•	•	•	
S025039090	25.00	39.00	9.00	X	•	•	•	•	•	•	•	•	•	
S025040050	25.00	40.00	5.00	X	X	•	X	•	•	•	•	•	•	
S025040060	25.00	40.00	6.00	X	X	•	X	•	•	•	•	•	•	
S025040070	25.00	40.00	7.00	X	X	•	X	X	•	•	X	•	•	
S025040080	25.00	40.00	8.00	X	X	•	X	X	•	•	•	•	•	
S025040090	25.00	40.00	9.00	•	•	X	X	•	•	•	•	•	•	
S025040100	25.00	40.00	10.00	X	X	X	X	X	X	•	•	•	•	
S025040110	25.00	40.00	11.00	X	•	•	•	•	•	•	•	•	•	
S025041060	25.00	41.00	6.00	•	•	•	X	•	•	•	•	•	•	
S025041070	25.00	41.00	7.00	•	•	•	X	•	•	•	•	•	•	
S025041080	25.00	41.00	8.00	•	•	•	X	•	•	•	•	•	•	
S025042060	25.00	42.00	6.00	X	•	•	X	•	•	•	•	•	•	
S025042065	25.00	42.00	6.50	X	•	•	•	•	•	•	•	•	•	
S025042070	25.00	42.00	7.00	X	X	•	X	X	•	•	•	•	•	
S025042080	25.00	42.00	8.00	X	X	•	X	•	•	•	•	•	•	
S025042085	25.00	42.00	8.50	X	•	•	•	•	•	•	•	•	•	
S025042090	25.00	42.00	9.00	X	•	X	•	•	•	•	•	•	•	
S025042100	25.00	42.00	10.00	X	X	X	X	X	X	•	•	•	•	
S025043080	25.00	43.00	8.00	•	•	•	X	•	•	•	•	•	•	
S025043090	25.00	43.00	9.00	X	•	X	•	•	•	•	•	•	•	
S025043100	25.00	43.00	10.00	•	•	•	X	•	•	•	•	•	•	
S025044070	25.00	44.00	7.00	X	•	X	X	•	•	•	•	•	•	
S025045040	25.00	45.00	4.00	•	•	•	•	•	•	•	X	•	•	
S025045050	25.00	45.00	5.00	•	•	•	•	•	•	X	•	•	•	
S025045060	25.00	45.00	6.00	X	•	•	•	•	•	•	•	•	•	
S025045070	25.00	45.00	7.00	X	•	•	X	•	•	•	•	•	•	
S025045080	25.00	45.00	8.00	•	•	•	X	X	•	•	•	•	•	
S025045090	25.00	45.00	9.00	•	•	•	X	•	•	•	•	•	•	
S025045100	25.00	45.00	10.00	X	X	X	X	X	•	•	•	•	•	
S025045110	25.00	45.00	11.00	X	•	•	X	•	•	•	•	•	•	
S025045125	25.00	45.00	12.50	•	•	•	•	•	X	•	•	•	•	
S025045140	25.00	45.00	14.00	•	•	•	•	•	•	•	•	•	•	
S025045180	25.00	45.00	18.00	•	•	•	X	•	•	•	•	•	•	
S025046070	25.00	46.00	7.00	X	•	•	X	•	•	•	•	•	•	
S025046150	25.00	46.00	15.00	•	•	•	X	•	•	•	•	•	•	
S025047050	25.00	47.00	5.00	•	•	•	•	•	•	•	X	•	•	
S025047060	25.00	47.00	6.00	X	•	•	X	•	•	•	X	•	•	
S025047070	25.00	47.00	7.00	X	X	•	X	X	•	•	•	•	•	
S025047080	25.00	47.00	8.00	X	X	•	X	X	•	•	•	•	•	
S025047090	25.00	47.00	9.00	•	•	X	•	•	•	•	•	•	•	
S025047100	25.00	47.00	10.00	X	X	X	X	X	X	•	•	•	•	
S025048070	25.00	48.00	7.00	•	•	•	X	•	•	•	•	•	•	

X: EXISTING TOOLING •: ON REQUEST









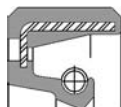

N.B.: MINIMUM LINE ORDER MAY APPLY

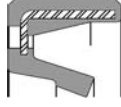

## GLOBAL AVAILABILITY LIST

## RADIAL SHAFT SEALS - NBR/STEEL

METRIC SIZE  
SHAFT SEALS

SC 	Ref. Number	Dimensions			DESIGN TYPE									
		d	D	H	SC	SB2	SA2	TC	TB2	TA2	VB	VC	KB	KC
	S025048080	25.00	48.00	8.00	X	•	•	X	•	•	•	•	•	•
	S025048100	25.00	48.00	10.00	•	•	•	X	•	•	•	•	•	•
	S025050070	25.00	50.00	7.00	X	•	•	•	•	•	•	•	•	•
	S025050080	25.00	50.00	8.00	•	•	•	X	•	•	•	•	•	•
	S025050100	25.00	50.00	10.00	X	•	X	X	•	•	•	•	•	•
	S025050120	25.00	50.00	12.00	X	X	X	•	•	•	•	•	•	•
	S025051110	25.00	51.00	11.00	X	•	•	•	•	•	•	•	•	•
	S025052050	25.00	52.00	5.00	X	•	•	•	•	•	•	•	•	•
	S025052064	25.00	52.00	6.40	X	•	•	•	•	•	•	•	•	•
	S025052070	25.00	52.00	7.00	X	X	•	X	X	•	•	•	•	•
	S025052080	25.00	52.00	8.00	X	X	•	X	•	•	•	•	•	•
	S025052090	25.00	52.00	9.00	•	•	X	•	•	•	•	•	•	•
	S025052100	25.00	52.00	10.00	X	X	X	X	X	X	•	•	•	•
	S025052120	25.00	52.00	12.00	X	X	X	X	X	•	•	•	•	•
	S025052150	25.00	52.00	15.00	X	•	•	X	•	•	•	•	•	•
	S025054070	25.00	54.00	7.00	X	•	•	•	•	•	•	•	•	•
	S025055090	25.00	55.00	9.00	•	•	•	X	•	•	•	•	•	•
	S025055100	25.00	55.00	10.00	X	•	•	X	•	•	•	•	•	•
	S025055110	25.00	55.00	11.00	X	•	•	X	•	•	•	•	•	•
	S025060070	25.00	60.00	7.00	X	•	•	•	•	•	•	•	•	•
	S025062070	25.00	62.00	7.00	X	X	•	X	•	•	•	•	•	•
	S025062080	25.00	62.00	8.00	X	•	•	X	•	•	•	•	•	•
	S025062100	25.00	62.00	10.00	X	X	X	X	•	•	•	•	•	•
	S025062120	25.00	62.00	12.00	•	X	X	•	•	•	•	•	•	•
	S025065120	25.00	65.00	12.00	•	•	•	X	•	•	•	•	•	•
	S025065140	25.00	65.00	14.00	•	•	•	X	•	•	•	•	•	•
	S025070120	25.00	70.00	12.00	•	•	•	X	•	•	•	•	•	•
	S025072070	25.00	72.00	7.00	X	•	•	•	•	•	•	•	•	•
	S026031030	26.00	31.00	3.00	•	•	•	•	•	•	X	•	•	•
	S026034040	26.00	34.00	4.00	•	•	•	•	•	•	•	X	•	•
	S026035050	26.00	35.00	5.00	•	•	•	•	•	•	X	•	•	•
	S026035070	26.00	35.00	7.00	X	X	•	•	•	•	•	•	•	•
	S026036030	26.00	36.00	3.00	•	•	•	•	•	•	•	X	•	•
	S026036070	26.00	36.00	7.00	X	•	•	X	•	•	•	•	•	•
	S026036080	26.00	36.00	8.00	•	X	•	•	•	•	•	•	•	•
	S026036100	26.00	36.00	10.00	•	•	•	X	•	•	•	•	•	•
	S026037070	26.00	37.00	7.00	X	X	•	X	•	•	•	•	•	•
	S026037100	26.00	37.00	10.00	X	•	•	X	•	•	•	•	•	•
	S026037105	26.00	37.00	10.50	•	•	•	•	•	•	•	•	•	•
	S026038050	26.00	38.00	5.00	X	•	•	X	•	•	•	•	•	•
	S026038070	26.00	38.00	7.00	X	•	•	X	•	•	•	•	•	•
	S026038080	26.00	38.00	8.00	•	•	•	X	•	•	•	•	•	•
	S026040050	26.00	40.00	5.00	•	•	•	X	•	•	•	•	•	•
	S026040060	26.00	40.00	6.00	X	•	•	X	•	•	•	•	•	•
	S026040070	26.00	40.00	7.00	X	X	•	X	X	•	•	•	•	•
	S026040080	26.00	40.00	8.00	X	•	•	•	•	•	•	•	•	•
	S026040090	26.00	40.00	9.00	X	•	•	X	•	•	•	•	•	•
	S026040100	26.00	40.00	10.00	X	•	•	•	•	•	•	•	•	•

X: EXISTING TOOLING    •: ON REQUEST

N.B.: MINIMUM LINE ORDER MAY APPLY

Tel.: (888) 238-5885  
Fax: (888) 238-1664

**SS 161**

[www.sealsonline.com](http://www.sealsonline.com)



## RADIAL SHAFT SEALS - NBR/STEEL

## GLOBAL AVAILABILITY LIST

Ref. Number	Dimensions			DESIGN TYPE										SC 
	d	D	H	SC	SB2	SA2	TC	TB2	TA2	VB	VC	KB	KC	
S026042060	26.00	42.00	6.00	X	•	•	•	•	•	•	•	•	•	
S026042070	26.00	42.00	7.00	X	X	•	X	•	•	•	•	•	•	
S026042080	26.00	42.00	8.00	X	•	•	X	•	•	•	•	•	•	
S026042090	26.00	42.00	9.00	•	•	X	•	•	•	•	•	•	•	
S026042100	26.00	42.00	10.00	X	X	X	X	•	•	•	•	•	•	
S026043080	26.00	43.00	8.00	•	•	•	X	•	•	•	•	•	•	
S026045060	26.00	45.00	6.00	•	•	•	X	•	•	•	•	•	•	
S026045070	26.00	45.00	7.00	X	•	•	•	•	•	•	•	•	•	
S026045090	26.00	45.00	9.00	•	•	•	X	•	•	•	•	•	•	
S026045100	26.00	45.00	10.00	•	X	•	•	X	•	•	•	•	•	
S026046080	26.00	46.00	8.00	•	•	•	X	•	•	•	•	•	•	
S026047050	26.00	47.00	5.00	X	•	•	•	•	•	•	•	•	•	
S026047070	26.00	47.00	7.00	X	•	•	X	•	•	•	•	•	•	
S026047090	26.00	47.00	9.00	•	•	X	X	•	•	•	•	•	•	
S026047100	26.00	47.00	10.00	X	•	X	X	•	•	•	•	•	•	
S026048070	26.00	48.00	7.00	•	•	•	X	•	•	•	•	•	•	
S026050100	26.00	50.00	10.00	X	•	•	•	•	•	•	•	•	•	
S026050120	26.00	50.00	12.00	•	•	X	•	•	•	•	•	•	•	
S026052070	26.00	52.00	7.00	•	•	•	X	•	•	•	•	•	•	
S026052078	26.00	52.00	7.80	•	•	•	X	•	•	•	•	•	•	
S026052080	26.00	52.00	8.00	X	X	•	X	•	•	•	•	•	•	
S026052090	26.00	52.00	9.00	•	•	•	X	•	•	•	•	•	•	
S026052100	26.00	52.00	10.00	X	•	•	X	•	•	•	•	•	•	
S026052120	26.00	52.00	12.00	•	•	X	•	•	•	•	•	•	•	
S026062090	26.00	62.00	9.00	•	•	•	X	•	•	•	•	•	•	
S026072100	26.00	72.00	10.00	•	•	•	X	•	•	•	•	•	•	
S027033030	27.00	33.00	3.00	•	•	•	•	•	•	X	•	•	•	
S027034030	27.00	34.00	3.00	•	•	•	•	•	•	X	•	•	•	
S027035040	27.00	35.00	4.00	X	•	•	•	•	•	•	•	•	•	
S027035070	27.00	35.00	7.00	X	•	•	•	•	•	•	•	•	•	
S027035075	27.00	35.00	7.50	X	•	•	•	•	•	•	•	•	•	
S027036040	27.00	36.00	4.00	•	•	•	•	•	•	•	X	•	•	
S027036060	27.00	36.00	6.00	•	•	•	X	•	•	•	•	•	•	
S027037050	27.00	37.00	5.00	•	•	•	•	X	•	•	X	•	•	
S027037070	27.00	37.00	7.00	X	•	•	X	•	•	•	•	•	•	
S027038060	27.00	38.00	6.00	X	•	•	•	•	•	•	•	•	•	
S027038070	27.00	38.00	7.00	X	•	•	X	•	•	•	•	•	•	
S027040030	27.00	40.00	3.00	•	•	•	•	•	•	•	X	•	•	
S027040060	27.00	40.00	6.00	X	•	•	X	•	•	•	•	•	•	
S027040070	27.00	40.00	7.00	X	•	•	X	•	•	•	•	•	•	
S027040080	27.00	40.00	8.00	•	•	•	X	•	•	•	•	•	•	
S027040100	27.00	40.00	10.00	X	•	•	•	•	•	•	•	•	•	
S027041100	27.00	41.00	10.00	X	•	X	•	•	•	•	•	•	•	
S027042070	27.00	42.00	7.00	X	•	•	•	•	•	•	•	•	•	
S027042100	27.00	42.00	10.00	X	X	X	X	•	•	•	•	•	•	
S027043080	27.00	43.00	8.00	•	•	•	X	•	•	•	•	•	•	
S027043090	27.00	43.00	9.00	X	X	•	X	X	•	•	X	•	•	
S027045070	27.00	45.00	7.00	X	•	•	•	•	•	•	•	•	•	

X: EXISTING TOOLING ••: ON REQUEST

N.B.: MINIMUM LINE ORDER MAY APPLY



## GLOBAL AVAILABILITY LIST

## RADIAL SHAFT SEALS - NBR/STEEL

METRIC SIZE  
SHAFT SEALS

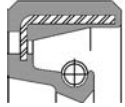
SC 	Ref. Number	Dimensions			DESIGN TYPE									
		d	D	H	SC	SB2	SA2	TC	TB2	TA2	VB	VC	KB	KC
	S027045080	27.00	45.00	8.00	X	.	.	X	.	.	.	.	.	.
	S027045090	27.00	45.00	9.00	.	.	.	X	.	.	.	.	.	.
	S027047060	27.00	47.00	6.00	X	.	.	.	.	.	.	.	.	.
	S027047070	27.00	47.00	7.00	X	.	.	.	.	.	.	.	.	.
	S027047080	27.00	47.00	8.00	X	.	.	X	.	.	.	.	.	.
	S027047098	27.00	47.00	9.80	X	.	.	.	.	.	.	.	.	.
	S027047100	27.00	47.00	10.00	X	.	X	.	.	.	.	.	.	.
	S027047110	27.00	47.00	11.00	.	.	.	X	.	.	.	.	.	.
	S027050100	27.00	50.00	10.00	X	.	.	X	.	.	.	.	.	.
	S027051100	27.00	51.00	10.00	.	.	.	X	.	.	.	.	.	.
	S027052080	27.00	52.00	8.00	X	X	X	.	.	.	.	.	.	.
	S027052100	27.00	52.00	10.00	X	.	.	.	.	.	.	.	.	.
	S027055080	27.00	55.00	8.00	.	.	.	X	.	.	.	.	.	.
	S027062120	27.00	62.00	12.00	.	.	X	.	.	.	.	.	.	.
	S027075120	27.00	75.00	12.00	.	.	.	X	.	.	.	.	.	.
	S028025060	28.00	25.00	6.00	.	.	.	.	.	.	X	.	.	.
	S028033060	28.00	33.00	6.00	.	.	.	.	.	.	.	X	.	.
	S028034040	28.00	34.00	4.00	.	.	.	.	.	.	.	X	.	.
	S028035040	28.00	35.00	4.00	.	.	.	.	.	.	X	X	.	.
	S028035050	28.00	35.00	5.00	.	.	.	X	X	.	X	.	.	.
	S028035070	28.00	35.00	7.00	.	.	.	X	.	.	.	X	.	.
	S028036050	28.00	36.00	5.00	.	.	.	.	.	.	X	X	.	.
	S028037040	28.00	37.00	4.00	.	.	.	.	.	.	.	X	.	.
	S028037050	28.00	37.00	5.00	.	.	.	X	.	.	.	.	.	.
	S028037060	28.00	37.00	6.00	.	.	.	X	.	.	.	.	.	.
	S028037080	28.00	37.00	8.00	X	.	.	.	.	.	.	.	.	.
	S028038050	28.00	38.00	5.00	X	.	.	.	.	.	.	.	.	.
	S028038055	28.00	38.00	5.50	X	.	.	.	.	.	.	.	.	.
	S028038060	28.00	38.00	6.00	X	.	.	.	.	.	.	.	.	.
	S028038070	28.00	38.00	7.00	X	X	.	X	.	.	.	X	.	.
	S028038080	28.00	38.00	8.00	X	.	.	X	.	.	.	.	.	.
	S028038100	28.00	38.00	10.00	.	.	.	X	.	.	.	.	.	.
	S028039070	28.00	39.00	7.00	.	X	.	.	.	.	.	.	.	.
	S028040050	28.00	40.00	5.00	X	.	.	X	.	.	.	X	.	.
	S028040070	28.00	40.00	7.00	X	X	.	X	.	.	.	.	.	.
	S028040080	28.00	40.00	8.00	X	X	.	X	X	.	.	.	.	.
	S028040090	28.00	40.00	9.00	X	.	.	.	.	.	.	.	.	.
	S028040100	28.00	40.00	10.00	X	X	X	X	.	.	.	.	.	.
	S028041110	28.00	41.00	11.00	.	.	.	X	.	.	.	.	.	.
	S028042060	28.00	42.00	6.00	.	.	.	X	.	.	.	.	.	.
	S028042070	28.00	42.00	7.00	X	X	.	X	.	.	.	.	.	.
	S028042080	28.00	42.00	8.00	X	.	.	X	.	.	.	.	.	.
	S028042100	28.00	42.00	10.00	X	.	.	X	.	.	.	.	.	.
	S028042110	28.00	42.00	11.00	.	.	.	X	.	.	.	.	.	.
	S028043065	28.00	43.00	6.50	.	.	.	.	X	.	.	.	.	.
	S028043070	28.00	43.00	7.00	X	.	.	.	.	.	.	.	.	.
	S028043080	28.00	43.00	8.00	.	.	.	X	.	.	.	.	.	.
	S028043090	28.00	43.00	9.00	X	.	.	.	.	.	.	.	.	.

X: EXISTING TOOLING    .: ON REQUEST

N.B.: MINIMUM LINE ORDER MAY APPLY

Tel.: (204) 783-9617  
Fax: (204) 783-6091

**SS 163**

[www.sealsonline.com](http://www.sealsonline.com)



**M**

## RADIAL SHAFT SEALS - NBR/STEEL

## GLOBAL AVAILABILITY LIST

Ref. Number	Dimensions			DESIGN TYPE										SC 
	d	D	H	SC	SB2	SA2	TC	TB2	TA2	VB	VC	KB	KC	
S028043100	28.00	43.00	10.00	X	X	•	X	•	•	•	•	•	•	
S028044070	28.00	44.00	7.00	•	•	•	X	X	•	•	•	•	•	
S028044080	28.00	44.00	8.00	•	•	•	•	X	•	•	•	•	•	
S028044100	28.00	44.00	10.00	X	•	•	•	•	•	•	•	•	•	
S028045050	28.00	45.00	5.00	X	•	•	X	•	•	•	•	•	•	
S028045060	28.00	45.00	6.00	X	•	•	X	•	•	•	•	•	•	
S028045070	28.00	45.00	7.00	X	•	•	X	•	•	•	•	•	•	
S028045075	28.00	45.00	7.50	•	X	•	•	•	•	•	•	•	•	
S028045080	28.00	45.00	8.00	X	X	•	X	•	•	•	•	•	•	
S028045090	28.00	45.00	9.00	X	•	•	•	•	•	•	•	•	•	
S028045100	28.00	45.00	10.00	•	X	•	X	•	•	•	•	•	•	
S028047050	28.00	47.00	5.00	X	•	•	•	•	•	•	•	•	•	
S028047070	28.00	47.00	7.00	X	X	•	X	•	•	•	•	•	•	
S028047080	28.00	47.00	8.00	X	X	X	X	•	•	•	•	•	•	
S028047090	28.00	47.00	9.00	•	•	X	X	•	•	•	•	•	•	
S028047100	28.00	47.00	10.00	X	X	X	X	X	•	•	•	•	•	
S028048050	28.00	48.00	5.00	X	•	•	•	•	•	•	•	•	•	
S028048070	28.00	48.00	7.00	X	•	•	•	•	•	•	•	•	•	
S028048080	28.00	48.00	8.00	•	X	•	X	•	•	•	•	•	•	
S028048100	28.00	48.00	10.00	X	•	•	•	•	•	•	•	•	•	
S028048110	28.00	48.00	11.00	X	•	•	X	X	•	•	•	•	•	
S028050060	28.00	50.00	6.00	•	•	•	X	•	•	•	•	•	•	
S028050080	28.00	50.00	8.00	X	•	•	•	•	•	•	•	•	•	
S028050100	28.00	50.00	10.00	X	•	X	X	•	•	•	•	•	•	
S028050110	28.00	50.00	11.00	•	•	•	X	•	•	•	•	•	•	
S028050120	28.00	50.00	12.00	X	X	•	•	•	•	•	•	•	•	
S028052050	28.00	52.00	5.00	X	•	•	•	•	•	•	•	•	•	
S028052060	28.00	52.00	6.00	•	•	•	X	•	•	•	•	•	•	
S028052070	28.00	52.00	7.00	X	X	•	X	•	•	•	•	•	•	
S028052090	28.00	52.00	9.00	•	•	X	•	•	•	•	•	•	•	
S028052100	28.00	52.00	10.00	X	•	•	X	•	•	•	•	•	•	
S028052120	28.00	52.00	12.00	X	•	X	•	•	•	•	•	•	•	
S028055100	28.00	55.00	10.00	X	•	•	•	•	•	•	•	•	•	
S028057120	28.00	57.00	12.00	X	•	•	•	•	•	•	•	•	•	
S028058070	28.00	58.00	7.00	•	X	•	•	•	•	•	•	•	•	
S028062100	28.00	62.00	10.00	X	•	•	•	•	•	•	•	•	•	
S028062120	28.00	62.00	12.00	X	•	X	•	•	•	•	•	•	•	
S029035035	29.00	35.00	3.50	•	•	•	•	•	•	•	X	•	•	
S029037060	29.00	37.00	6.00	•	•	•	•	•	•	X	•	•	•	
S029038040	29.00	38.00	4.00	•	•	•	•	•	•	•	X	•	•	
S029038060	29.00	38.00	6.00	X	•	•	•	•	•	•	•	•	•	
S029039040	29.00	39.00	4.00	•	•	•	•	•	•	•	X	•	•	
S029039050	29.00	39.00	5.00	X	•	•	•	•	•	•	•	•	•	
S029040070	29.00	40.00	7.00	X	X	•	X	•	•	•	•	•	•	
S029040080	29.00	40.00	8.00	•	•	•	X	•	•	•	•	•	•	
S029041050	29.00	41.00	5.00	X	•	•	•	•	•	•	•	•	•	
S029041060	29.00	41.00	6.00	X	•	•	•	•	•	•	•	•	•	
S029042070	29.00	42.00	7.00	X	•	•	•	•	•	•	•	•	•	

X: EXISTING TOOLING •: ON REQUEST

N.B.: MINIMUM LINE ORDER MAY APPLY



## GLOBAL AVAILABILITY LIST

## RADIAL SHAFT SEALS - NBR/STEEL

METRIC SIZE  
SHAFT SEALS

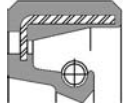
SC 	Ref. Number	Dimensions			DESIGN TYPE									
		d	D	H	SC	SB2	SA2	TC	TB2	TA2	VB	VC	KB	KC
	S029042080	29.00	42.00	8.00	X	.	.	.	.	.	.	.	.	.
	S029043070	29.00	43.00	7.00	X	.	.	.	.	.	.	.	.	.
	S029043080	29.00	43.00	8.00	.	.	.	.	.	X	.	.	.	.
	S029045070	29.00	45.00	7.00	X	.	.	.	.	.	.	.	.	.
	S029045080	29.00	45.00	8.00	X	.	.	X	.	.	.	.	.	.
	S029045090	29.00	45.00	9.00	X	.	.	X	.	.	.	.	.	.
	S029045095	29.00	45.00	9.50	X	X	.	.	.	.	.	.	.	.
	S029045100	29.00	45.00	10.00	X	X	.	.	.	.	.	.	.	.
	S029045120	29.00	45.00	12.00	.	.	.	X	.	.	.	.	.	.
	S029046100	29.00	46.00	10.00	X	.	.	.	.	.	.	.	.	.
	S029047070	29.00	47.00	7.00	X	.	.	.	.	.	.	.	.	.
	S029047100	29.00	47.00	10.00	X	.	X	.	.	.	.	.	.	.
	S029048100	29.00	48.00	10.00	X	.	.	.	.	.	.	.	.	.
	S029050100	29.00	50.00	10.00	X	.	X	.	.	.	.	.	.	.
	S029050120	29.00	50.00	12.00	X	.	.	.	.	.	.	.	.	.
	S029052090	29.00	52.00	9.00	X	.	.	.	.	.	.	.	.	.
	S029052100	29.00	52.00	10.00	.	.	X	.	.	.	.	.	.	.
	S029055090	29.00	55.00	9.00	X	.	.	.	.	.	.	.	.	.
	S029062100	29.00	62.00	10.00	X	.	.	.	.	.	.	.	.	.
	S030035030	30.00	35.00	3.00	.	.	.	.	.	.	X	.	.	.
	S030036050	30.00	36.00	5.00	X	.	.	.	.	.	.	.	.	.
	S030037030	30.00	37.00	3.00	.	.	.	.	.	.	X	.	.	.
	S030037032	30.00	37.00	3.20	.	.	.	.	.	.	.	X	.	.
	S030037040	30.00	37.00	4.00	X	.	.	.	.	.	X	X	.	.
	S030037045	30.00	37.00	4.50	.	.	.	.	.	.	X	.	.	.
	S030037080	30.00	37.00	8.00	.	.	.	.	.	.	.	X	.	.
	S030038050	30.00	38.00	5.00	.	X	.	.	.	.	.	.	.	.
	S030039070	30.00	39.00	7.00	.	X	.	.	.	.	X	.	.	.
	S030040040	30.00	40.00	4.00	.	.	.	.	.	.	X	X	.	.
	S030040050	30.00	40.00	5.00	X	.	.	X	.	.	X	X	.	.
	S030040060	30.00	40.00	6.00	.	.	.	.	.	.	X	.	.	.
	S030040070	30.00	40.00	7.00	X	X	.	X	.	.	.	.	.	.
	S030040080	30.00	40.00	8.00	X	.	.	X	.	.	.	.	.	.
	S030040090	30.00	40.00	9.00	X	.	.	.	.	.	.	.	.	.
	S030040100	30.00	40.00	10.00	X	.	.	.	.	.	.	.	.	.
	S030041063	30.00	41.00	6.30	X	.	.	.	.	.	.	.	.	.
	S030041070	30.00	41.00	7.00	.	.	.	X	.	.	.	.	.	.
	S030042045	30.00	42.00	4.50	X	.	.	.	.	.	.	.	.	.
	S030042050	30.00	42.00	5.00	.	.	.	X	.	.	X	X	.	.
	S030042057	30.00	42.00	5.70	X	.	.	.	.	.	.	.	.	.
	S030042060	30.00	42.00	6.00	X	X	.	X	.	.	.	.	.	.
	S030042065	30.00	42.00	6.50	.	.	.	X	.	.	.	.	.	.
	S030042070	30.00	42.00	7.00	X	X	.	X	X	.	.	.	.	.
	S030042079	30.00	42.00	7.90	.	.	.	X	.	.	.	.	.	.
	S030042080	30.00	42.00	8.00	X	X	.	X	.	.	.	.	.	.
	S030042100	30.00	42.00	10.00	X	.	.	X	.	.	.	.	.	.
	S030042120	30.00	42.00	12.00	X	.	.	X	.	.	.	.	.	.
	S030043080	30.00	43.00	8.00	X	X	.	X	.	X	.	.	.	.

X: EXISTING TOOLING    .: ON REQUEST

N.B.: MINIMUM LINE ORDER MAY APPLY

Tel.: (780) 414-1871  
Fax: (780) 487-5419

**SS 165**

[www.sealsonline.com](http://www.sealsonline.com)



**M**

## RADIAL SHAFT SEALS - NBR/STEEL

## GLOBAL AVAILABILITY LIST

Ref. Number	Dimensions			DESIGN TYPE									SC
	d	D	H	SC	SB2	SA2	TC	TB2	TA2	VB	VC	KB	
S030043085	30.00	43.00	8.50	•	•	•	X	•	•	•	•	•	•
S030043100	30.00	43.00	10.00	•	X	•	X	•	•	•	•	•	•
S030044070	30.00	44.00	7.00	X	•	•	X	X	•	•	•	•	•
S030044080	30.00	44.00	8.00	X	•	•	•	•	•	•	•	•	•
S030044090	30.00	44.00	9.00	•	•	•	X	X	•	•	•	•	•
S030044100	30.00	44.00	10.00	X	X	•	•	•	•	•	•	•	•
S030045050	30.00	45.00	5.00	X	•	•	X	•	•	•	•	•	•
S030045055	30.00	45.00	5.50	X	•	•	•	•	•	•	•	•	•
S030045060	30.00	45.00	6.00	X	•	•	•	X	•	X	X	•	•
S030045070	30.00	45.00	7.00	X	X	•	X	•	•	•	•	•	•
S030045080	30.00	45.00	8.00	X	X	•	X	•	•	•	•	•	•
S030045085	30.00	45.00	8.50	•	•	•	•	•	•	•	•	•	•
S030045090	30.00	45.00	9.00	•	•	•	X	•	•	•	•	•	•
S030045095	30.00	45.00	9.50	•	X	X	•	•	•	•	•	•	•
S030045100	30.00	45.00	10.00	X	•	X	X	X	X	•	•	•	•
S030045110	30.00	45.00	11.00	•	•	•	X	•	•	•	•	•	•
S030045120	30.00	45.00	12.00	•	•	•	•	•	•	•	•	•	•
S030046050	30.00	46.00	5.00	X	•	•	X	•	•	•	•	•	•
S030046070	30.00	46.00	7.00	•	•	•	X	•	•	•	•	•	•
S030046080	30.00	46.00	8.00	X	•	•	X	•	•	•	•	•	•
S030046100	30.00	46.00	10.00	X	•	X	•	•	•	•	•	•	•
S030047050	30.00	47.00	5.00	X	•	•	X	•	•	•	•	•	•
S030047060	30.00	47.00	6.00	X	•	•	X	•	•	•	•	•	•
S030047070	30.00	47.00	7.00	X	X	•	X	X	•	•	•	•	•
S030047080	30.00	47.00	8.00	X	X	•	X	X	•	•	•	•	•
S030047090	30.00	47.00	9.00	•	•	X	•	•	•	•	•	•	•
S030047100	30.00	47.00	10.00	X	X	X	X	X	X	•	•	•	•
S030047140	30.00	47.00	14.00	•	•	•	•	•	•	•	•	•	•
S030048070	30.00	48.00	7.00	•	•	•	X	•	•	•	•	•	•
S030048080	30.00	48.00	8.00	X	•	•	X	•	•	•	•	•	•
S030048100	30.00	48.00	10.00	X	X	•	X	•	•	•	•	•	•
S030049070	30.00	49.00	7.00	•	•	•	X	•	•	•	•	•	•
S030049090	30.00	49.00	9.00	X	•	•	•	•	•	•	•	•	•
S030050050	30.00	50.00	5.00	•	•	•	•	•	•	•	X	•	•
S030050070	30.00	50.00	7.00	X	X	•	X	X	X	•	•	•	•
S030050080	30.00	50.00	8.00	X	•	•	X	•	•	•	•	•	•
S030050090	30.00	50.00	9.00	•	•	X	•	•	•	•	•	•	•
S030050100	30.00	50.00	10.00	X	X	X	X	X	X	•	•	•	•
S030050110	30.00	50.00	11.00	X	•	•	X	X	•	•	•	•	•
S030050120	30.00	50.00	12.00	X	X	X	•	X	X	•	•	•	•
S030050150	30.00	50.00	15.00	•	•	•	X	•	•	•	•	•	•
S030051060	30.00	51.00	6.00	•	X	•	•	•	•	•	•	•	•
S030051080	30.00	51.00	8.00	•	•	•	X	•	•	•	•	•	•
S030051100	30.00	51.00	10.00	•	•	•	•	•	•	•	•	•	•
S030052040	30.00	52.00	4.00	X	•	•	•	•	•	•	•	•	•
S030052050	30.00	52.00	5.00	X	•	•	•	•	•	•	•	•	•
S030052060	30.00	52.00	6.00	X	•	•	•	•	•	•	•	•	•
S030052070	30.00	52.00	7.00	X	X	•	X	X	•	•	•	•	•

X: EXISTING TOOLING •: ON REQUEST



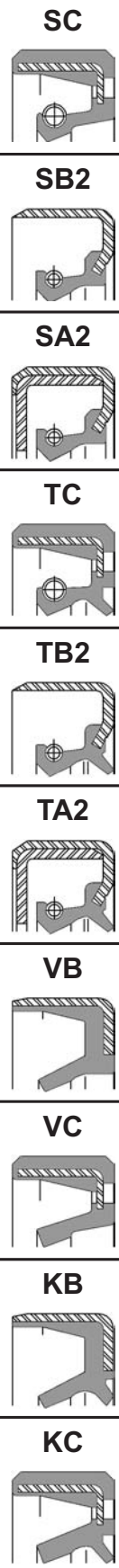







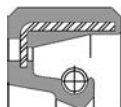
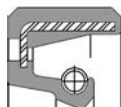



N.B.: MINIMUM LINE ORDER MAY APPLY

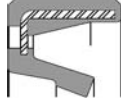
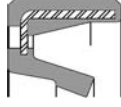

## GLOBAL AVAILABILITY LIST

## RADIAL SHAFT SEALS - NBR/STEEL

METRIC SIZE  
SHAFT SEALS

SC 	Ref. Number	Dimensions			DESIGN TYPE									
		d	D	H	SC	SB2	SA2	TC	TB2	TA2	VB	VC	KB	KC
	S030052080	30.00	52.00	8.00	X	•	•	X	•	•	•	•	•	•
	S030052085	30.00	52.00	8.50	X	•	•	•	•	•	•	•	•	•
	S030052090	30.00	52.00	9.00	•	•	X	•	•	X	•	•	•	•
	S030052100	30.00	52.00	10.00	X	X	X	X	X	X	•	•	•	•
	S030052110	30.00	52.00	11.00	•	•	•	X	•	•	•	•	•	•
	S030052120	30.00	52.00	12.00	X	X	X	X	X	X	•	•	•	•
	S030054100	30.00	54.00	10.00	X	•	•	•	•	•	•	•	•	•
	S030054120	30.00	54.00	12.00	•	•	•	X	•	•	•	•	•	•
	S030055060	30.00	55.00	6.00	X	•	•	X	•	•	•	•	•	•
	S030055070	30.00	55.00	7.00	X	•	•	X	X	•	•	•	•	•
	S030055080	30.00	55.00	8.00	•	•	•	X	•	•	•	•	•	•
	S030055100	30.00	55.00	10.00	X	X	X	X	X	X	•	•	•	•
	S030055110	30.00	55.00	11.00	•	•	•	X	•	•	•	•	•	•
	S030055120	30.00	55.00	12.00	X	X	X	X	X	X	•	•	•	•
	S030055150	30.00	55.00	15.00	•	•	•	•	•	•	X	•	•	•
	S030056060	30.00	56.00	6.00	•	X	•	X	•	•	•	•	•	•
	S030056070	30.00	56.00	7.00	X	•	•	•	•	•	•	•	•	•
	S030056080	30.00	56.00	8.00	X	•	•	X	•	•	•	•	•	•
	S030056100	30.00	56.00	10.00	X	•	X	X	•	•	•	•	•	•
	S030056120	30.00	56.00	12.00	X	•	X	•	•	•	•	•	•	•
	S030057080	30.00	57.00	8.00	X	•	•	•	•	•	•	•	•	•
	S030060070	30.00	60.00	7.00	•	•	X	•	•	•	•	•	•	•
	S030060100	30.00	60.00	10.00	X	X	X	X	X	X	•	•	•	•
	S030060120	30.00	60.00	12.00	•	X	X	X	X	X	•	•	•	•
	S030062050	30.00	62.00	5.00	X	•	•	•	•	•	•	•	•	•
	S030062060	30.00	62.00	6.00	•	X	•	•	•	•	•	X	•	•
	S030062065	30.00	62.00	6.50	X	•	•	•	•	•	•	•	•	•
	S030062070	30.00	62.00	7.00	X	X	•	X	X	•	•	•	•	•
	S030062080	30.00	62.00	8.00	X	•	•	X	•	•	•	•	•	•
	S030062090	30.00	62.00	9.00	•	•	X	X	•	•	•	•	•	•
	S030062100	30.00	62.00	10.00	X	X	X	X	X	X	•	•	•	•
	S030062115	30.00	62.00	11.50	•	•	•	X	•	•	•	•	•	•
	S030062120	30.00	62.00	12.00	X	X	X	X	X	X	•	•	•	•
	S030062130	30.00	62.00	13.00	•	X	•	•	•	•	•	•	•	•
	S030062140	30.00	62.00	14.00	•	•	•	•	•	•	•	•	•	•
	S030065080	30.00	65.00	8.00	X	•	•	•	•	•	•	•	•	•
	S030065100	30.00	65.00	10.00	X	•	•	X	•	•	•	•	•	•
	S030066120	30.00	66.00	12.00	•	•	•	X	•	•	•	•	•	•
	S030070100	30.00	70.00	10.00	X	•	•	X	•	•	•	•	•	•
	S030072070	30.00	72.00	7.00	•	•	•	•	X	•	•	•	•	•
	S030072080	30.00	72.00	8.00	•	•	•	X	•	•	•	•	•	•
	S030072100	30.00	72.00	10.00	X	X	X	X	X	•	•	•	•	•
	S030072120	30.00	72.00	12.00	•	•	X	•	X	X	•	•	•	•
	S030075090	30.00	75.00	9.00	•	•	•	X	•	•	•	•	•	•
	S030075100	30.00	75.00	10.00	•	•	•	X	•	•	•	•	•	•
	S030077090	30.00	77.00	9.00	•	•	•	X	•	•	•	•	•	•
	S030077100	30.00	77.00	10.00	•	•	•	X	•	•	•	•	•	•
	S030080100	30.00	80.00	10.00	•	•	•	X	•	•	•	•	•	•

X: EXISTING TOOLING    •: ON REQUEST

N.B.: MINIMUM LINE ORDER MAY APPLY

Tel.: (604) 278-6808  
Fax: (604) 278-6180

**SS 167**

[www.sealsonline.com](http://www.sealsonline.com)





## RADIAL SHAFT SEALS - NBR/STEEL

## GLOBAL AVAILABILITY LIST

Ref. Number	Dimensions			DESIGN TYPE										SC 
	d	D	H	SC	SB2	SA2	TC	TB2	TA2	VB	VC	KB	KC	
S031037030	31.00	37.00	3.00	•	•	•	•	•	•	•	X	•	•	•
S031041050	31.00	41.00	5.00	X	•	•	•	•	•	•	•	•	•	•
S031042120	31.00	42.00	12.00	•	X	•	•	•	•	•	•	•	•	•
S031043080	31.00	43.00	8.00	•	•	•	X	•	•	•	•	•	•	•
S031044070	31.00	44.00	7.00	•	•	•	X	•	•	•	•	•	•	•
S031046060	31.00	46.00	6.00	•	•	•	X	•	•	•	•	•	•	•
S031047070	31.00	47.00	7.00	X	•	•	•	•	•	•	•	•	•	•
S031047080	31.00	47.00	8.00	•	•	•	X	•	•	•	•	•	•	•
S031047100	31.00	47.00	10.00	X	•	X	•	•	•	•	•	•	•	•
S031048070	31.00	48.00	7.00	•	•	•	X	•	•	•	•	•	•	•
S031048100	31.00	48.00	10.00	•	•	•	X	•	•	•	•	•	•	•
S031049070	31.00	49.00	7.00	•	•	•	X	•	•	•	•	•	•	•
S031050100	31.00	50.00	10.00	•	•	X	•	•	•	•	•	•	•	•
S031051070	31.00	51.00	7.00	•	•	•	X	•	•	•	•	•	•	•
S031052060	31.00	52.00	6.00	X	•	•	X	•	•	•	•	•	•	•
S031052070	31.00	52.00	7.00	X	•	•	•	•	•	•	•	•	•	•
S031052080	31.00	52.00	8.00	X	•	•	•	•	•	•	•	•	•	•
S031052090	31.00	52.00	9.00	X	•	•	•	•	•	•	•	•	•	•
S031052120	31.00	52.00	12.00	•	•	•	•	X	•	•	•	•	•	•
S031055090	31.00	55.00	9.00	X	•	•	•	•	•	•	•	•	•	•
S032040050	32.00	40.00	5.00	X	•	•	•	X	•	X	•	•	•	•
S032040070	32.00	40.00	7.00	X	•	•	•	•	•	•	•	•	•	•
S032042040	32.00	42.00	4.00	•	•	•	•	•	•	X	X	•	•	•
S032042050	32.00	42.00	5.00	X	•	•	•	•	•	•	•	•	•	•
S032042060	32.00	42.00	6.00	X	•	•	X	•	•	•	•	•	•	•
S032042070	32.00	42.00	7.00	X	X	•	X	X	•	•	•	•	•	•
S032042080	32.00	42.00	8.00	•	•	•	X	•	•	•	•	•	•	•
S032042090	32.00	42.00	9.00	X	•	•	•	•	•	•	•	•	•	•
S032042140	32.00	42.00	14.00	•	•	•	•	•	•	X	•	•	•	•
S032043055	32.00	43.00	5.50	•	•	•	X	•	•	•	•	•	•	•
S032043070	32.00	43.00	7.00	•	•	•	X	•	•	•	•	•	•	•
S032043080	32.00	43.00	8.00	•	X	•	•	•	•	•	•	•	•	•
S032043100	32.00	43.00	10.00	•	X	•	•	•	•	•	•	•	•	•
S032044070	32.00	44.00	7.00	X	•	•	X	•	•	•	•	•	•	•
S032044080	32.00	44.00	8.00	•	•	•	X	•	•	•	•	•	•	•
S032044090	32.00	44.00	9.00	•	X	•	X	•	•	•	•	•	•	•
S032044100	32.00	44.00	10.00	•	•	•	X	X	•	•	•	•	•	•
S032044120	32.00	44.00	12.00	•	•	•	X	•	•	•	•	•	•	•
S032045040	32.00	45.00	4.00	•	•	•	•	•	•	•	X	•	•	•
S032045050	32.00	45.00	5.00	•	•	•	X	•	•	•	•	•	•	•
S032045060	32.00	45.00	6.00	X	•	•	•	•	•	•	•	•	•	•
S032045070	32.00	45.00	7.00	X	X	•	X	•	•	•	•	•	•	•
S032045077	32.00	45.00	7.70	•	•	•	X	•	•	•	•	•	•	•
S032045080	32.00	45.00	8.00	X	•	•	X	•	•	•	•	•	•	•
S032045100	32.00	45.00	10.00	X	•	•	X	•	•	•	•	•	•	•
S032045120	32.00	45.00	12.00	•	•	•	X	•	•	•	•	•	•	•
S032046070	32.00	46.00	7.00	X	•	•	X	•	•	•	•	•	•	•
S032046080	32.00	46.00	8.00	•	X	•	X	•	•	•	•	•	•	•

X: EXISTING TOOLING •: ON REQUEST

N.B.: MINIMUM LINE ORDER MAY APPLY



## GLOBAL AVAILABILITY LIST

## RADIAL SHAFT SEALS - NBR/STEEL

METRIC SIZE  
SHAFT SEALS

SC 	Ref. Number	Dimensions			DESIGN TYPE									
		d	D	H	SC	SB2	SA2	TC	TB2	TA2	VB	VC	KB	KC
	S032046100	32.00	46.00	10.00	X	•	•	•	•	•	•	•	•	•
	S032047070	32.00	47.00	7.00	X	X	•	X	X	•	•	•	•	•
	S032047080	32.00	47.00	8.00	X	•	•	•	•	•	•	•	•	•
	S032047090	32.00	47.00	9.00	•	•	X	X	•	•	•	•	•	•
	S032047100	32.00	47.00	10.00	X	X	X	X	X	•	•	•	•	•
	S032047120	32.00	47.00	12.00	•	•	•	X	•	•	•	•	•	•
	S032048050	32.00	48.00	5.00	X	•	•	•	•	•	•	•	•	•
	S032048060	32.00	48.00	6.00	•	•	•	•	•	•	X	•	•	•
	S032048070	32.00	48.00	7.00	X	X	•	X	•	•	•	•	•	•
	S032048080	32.00	48.00	8.00	X	X	•	X	•	•	•	•	•	•
	S032048090	32.00	48.00	9.00	X	•	•	•	•	•	•	•	•	•
	S032048100	32.00	48.00	10.00	X	•	•	X	•	•	•	•	•	•
	S032048110	32.00	48.00	11.00	•	•	•	X	•	•	•	•	•	•
	S032050070	32.00	50.00	7.00	X	X	•	•	•	•	•	•	•	•
	S032050080	32.00	50.00	8.00	X	•	X	X	•	•	•	•	•	•
	S032050100	32.00	50.00	10.00	X	•	X	X	•	•	•	•	•	•
	S032050120	32.00	50.00	12.00	X	•	X	•	•	•	•	•	•	•
	S032051080	32.00	51.00	8.00	X	•	•	X	•	•	•	•	•	•
	S032051090	32.00	51.00	9.00	X	•	•	•	•	•	•	•	•	•
	S032051095	32.00	51.00	9.50	X	•	•	X	•	•	•	•	•	•
	S032051120	32.00	51.00	12.00	•	•	•	X	•	•	•	•	•	•
	S032051195	32.00	51.00	19.50	X	•	•	•	•	•	•	•	•	•
	S032052050	32.00	52.00	5.00	X	•	•	•	•	•	•	•	•	•
	S032052065	32.00	52.00	6.50	•	•	•	•	X	•	•	•	•	•
	S032052070	32.00	52.00	7.00	X	X	•	X	•	•	•	•	•	•
	S032052075	32.00	52.00	7.50	X	•	•	•	•	•	•	•	•	•
	S032052080	32.00	52.00	8.00	X	X	•	X	•	•	•	•	•	•
	S032052090	32.00	52.00	9.00	X	•	X	•	•	•	•	•	•	•
	S032052100	32.00	52.00	10.00	X	X	X	X	X	•	•	•	•	•
	S032052110	32.00	52.00	11.00	•	•	•	X	X	•	•	•	•	•
	S032052120	32.00	52.00	12.00	X	X	X	•	X	•	•	•	•	•
	S032054080	32.00	54.00	8.00	X	•	•	•	•	•	•	•	•	•
	S032054100	32.00	54.00	10.00	•	•	X	X	•	•	•	•	•	•
	S032055080	32.00	55.00	8.00	•	•	•	X	•	•	•	•	•	•
	S032055100	32.00	55.00	10.00	X	X	X	X	•	•	•	•	•	•
	S032055110	32.00	55.00	11.00	•	•	•	X	•	•	•	•	•	•
	S032055120	32.00	55.00	12.00	•	•	X	•	•	•	•	•	•	•
	S032056100	32.00	56.00	10.00	X	X	X	X	•	•	•	•	•	•
	S032056110	32.00	56.00	11.00	•	•	•	X	•	•	•	•	•	•
	S032056120	32.00	56.00	12.00	X	•	X	•	•	•	•	•	•	•
	S032057075	32.00	57.00	7.50	•	•	•	X	•	•	•	•	•	•
	S032057120	32.00	57.00	12.00	X	•	•	•	•	•	•	•	•	•
	S032058065	32.00	58.00	6.50	•	•	•	•	•	•	X	•	•	•
	S032058100	32.00	58.00	10.00	•	•	•	X	•	•	•	•	•	•
	S032058120	32.00	58.00	12.00	•	•	•	•	X	•	•	•	•	•
	S032060100	32.00	60.00	10.00	•	X	X	X	•	•	•	•	•	•
	S032060120	32.00	60.00	12.00	•	•	X	•	•	•	•	•	•	•
	S032062060	32.00	62.00	6.00	X	•	•	•	•	•	•	•	•	•

X: EXISTING TOOLING    •: ON REQUEST

N.B.: MINIMUM LINE ORDER MAY APPLY

Tel.: (418) 688-3202  
Fax: (418) 688-4272

**SS 169**

[www.sealsonline.com](http://www.sealsonline.com)



## RADIAL SHAFT SEALS - NBR/STEEL

## GLOBAL AVAILABILITY LIST

Ref. Number	Dimensions			DESIGN TYPE										SC 
	d	D	H	SC	SB2	SA2	TC	TB2	TA2	VB	VC	KB	KC	
S032062070	32.00	62.00	7.00	•	•	•	X	•	•	•	•	•	•	
S032062080	32.00	62.00	8.00	X	•	•	•	•	•	•	•	•	•	
S032062100	32.00	62.00	10.00	X	•	X	X	•	•	•	•	•	•	
S032062120	32.00	62.00	12.00	X	•	X	•	•	•	•	•	•	•	
S032065065	32.00	65.00	6.50	•	•	•	X	•	•	•	•	•	•	
S032065090	32.00	65.00	9.00	•	•	•	X	•	•	•	•	•	•	
S032065100	32.00	65.00	10.00	•	X	X	•	•	•	•	•	•	•	
S032065120	32.00	65.00	12.00	•	•	X	X	•	•	•	•	•	•	
S032065130	32.00	65.00	13.00	•	•	•	X	•	•	•	•	•	•	
S032066100	32.00	66.00	10.00	X	•	•	•	•	•	•	•	•	•	
S032070080	32.00	70.00	8.00	X	•	•	•	•	•	•	•	•	•	
S032072080	32.00	72.00	8.00	•	•	•	X	•	•	•	•	•	•	
S032072100	32.00	72.00	10.00	•	•	•	X	•	•	•	•	•	•	
S032072120	32.00	72.00	12.00	•	•	X	X	•	•	•	•	•	•	
S032078095	32.00	78.00	9.50	•	•	•	X	•	•	•	•	•	•	
S032078100	32.00	78.00	10.00	•	•	•	X	•	•	•	•	•	•	
S033040030	33.00	40.00	3.00	•	•	•	•	•	•	X	•	•	•	
S033042050	33.00	42.00	5.00	•	•	•	•	•	•	•	X	•	•	
S033043070	33.00	43.00	7.00	X	•	•	•	•	•	•	•	•	•	
S033044080	33.00	44.00	8.00	•	•	•	X	•	•	•	•	•	•	
S033044089	33.00	44.00	8.90	•	•	•	X	•	•	•	•	•	•	
S033045055	33.00	45.00	5.50	•	•	•	•	•	•	X	•	•	•	
S033045070	33.00	45.00	7.00	X	•	•	•	•	•	•	•	•	•	
S033045100	33.00	45.00	10.00	•	•	•	X	•	•	•	•	•	•	
S033047110	33.00	47.00	11.00	X	•	•	•	•	•	•	•	•	•	
S033048089	33.00	48.00	8.90	•	•	•	X	•	•	•	•	•	•	
S033048120	33.00	48.00	12.00	X	•	•	•	•	•	•	•	•	•	
S033050060	33.00	50.00	6.00	X	•	•	X	•	•	•	•	•	•	
S033050070	33.00	50.00	7.00	X	•	•	X	•	•	•	•	•	•	
S033050080	33.00	50.00	8.00	X	•	•	•	X	•	•	•	•	•	
S033050100	33.00	50.00	10.00	X	•	X	X	•	•	•	•	•	•	
S033050110	33.00	50.00	11.00	•	•	•	X	•	•	•	•	•	•	
S033050120	33.00	50.00	12.00	•	•	•	X	X	•	•	•	•	•	
S033052020	33.00	52.00	2.00	•	•	•	•	•	•	•	X	•	•	
S033052060	33.00	52.00	6.00	X	•	•	•	•	•	•	•	•	•	
S033052080	33.00	52.00	8.00	X	•	•	X	•	•	•	•	•	•	
S033052100	33.00	52.00	10.00	X	•	X	•	•	•	•	•	•	•	
S033055100	33.00	55.00	10.00	X	•	•	•	•	•	•	•	•	•	
S033056120	33.00	56.00	12.00	X	•	•	•	•	•	•	•	•	•	
S033059120	33.00	59.00	12.00	•	•	•	X	•	•	•	•	•	•	
S033062100	33.00	62.00	10.00	•	•	X	•	•	•	•	•	•	•	
S033062120	33.00	62.00	12.00	•	•	X	•	•	•	•	•	•	•	
S033072120	33.00	72.00	12.00	•	•	X	•	•	•	•	•	•	•	
S034042140	34.00	42.00	14.00	•	•	•	•	•	•	X	•	•	•	
S034044060	34.00	44.00	6.00	X	•	•	•	•	•	•	•	•	•	
S034044070	34.00	44.00	7.00	X	•	•	•	•	•	•	•	•	•	
S034045070	34.00	45.00	7.00	X	X	•	X	•	•	•	•	•	•	
S034045090	34.00	45.00	9.00	•	•	•	X	•	•	•	•	•	•	

X: EXISTING TOOLING •: ON REQUEST



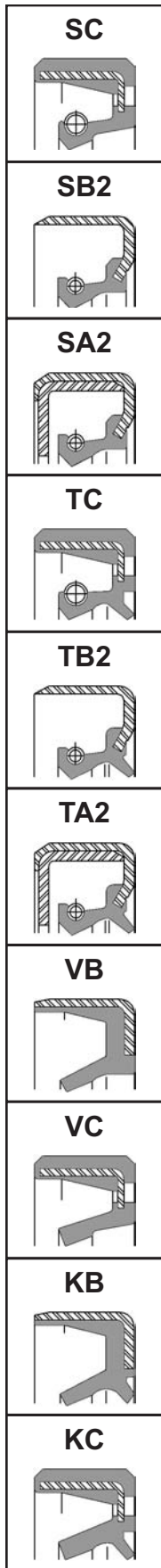





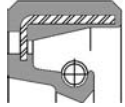

N.B.: MINIMUM LINE ORDER MAY APPLY



## GLOBAL AVAILABILITY LIST

## RADIAL SHAFT SEALS - NBR/STEEL

METRIC SIZE  
SHAFT SEALS

SC 	Ref. Number	Dimensions			DESIGN TYPE									
		d	D	H	SC	SB2	SA2	TC	TB2	TA2	VB	VC	KB	KC
	S034045110	34.00	45.00	11.00	•	•	•	X	•	•	•	•	•	•
	S034046080	34.00	46.00	8.00	X	X	•	X	•	•	•	•	•	•
	S034046100	34.00	46.00	10.00	X	•	•	•	•	•	•	•	•	•
	S034047070	34.00	47.00	7.00	•	•	•	X	•	•	•	•	•	•
	S034047090	34.00	47.00	9.00	X	X	•	•	•	•	•	•	•	•
	S034047120	34.00	47.00	12.00	X	•	•	•	•	•	•	•	•	•
	S034048070	34.00	48.00	7.00	X	•	•	X	•	•	•	•	•	•
	S034048080	34.00	48.00	8.00	X	•	•	X	•	•	•	•	•	•
	S034048110	34.00	48.00	11.00	•	•	•	X	•	•	•	•	•	•
	S034050070	34.00	50.00	7.00	•	•	•	X	•	•	•	•	•	•
	S034050080	34.00	50.00	8.00	X	•	•	•	•	•	•	•	•	•
	S034050100	34.00	50.00	10.00	X	•	X	•	•	•	•	•	•	•
	S034050110	34.00	50.00	11.00	•	•	•	X	•	•	•	•	•	•
	S034050120	34.00	50.00	12.00	•	•	•	X	•	•	•	•	•	•
	S034051080	34.00	51.00	8.00	X	•	•	•	•	•	•	•	•	•
	S034052070	34.00	52.00	7.00	•	X	•	X	•	•	•	•	•	•
	S034052075	34.00	52.00	7.50	X	•	•	•	•	•	•	•	•	•
	S034052080	34.00	52.00	8.00	X	X	•	•	•	•	•	•	•	•
	S034052100	34.00	52.00	10.00	X	X	X	X	•	•	•	•	•	•
	S034052110	34.00	52.00	11.00	X	•	•	X	•	•	•	•	•	•
	S034054075	34.00	54.00	7.50	•	•	•	X	•	•	•	•	•	•
	S034054100	34.00	54.00	10.00	•	•	•	X	•	•	•	•	•	•
	S034054110	34.00	54.00	11.00	•	•	•	X	•	•	•	•	•	•
	S034054125	34.00	54.00	12.50	•	•	•	X	•	•	•	•	•	•
	S034055090	34.00	55.00	9.00	X	•	•	X	•	•	•	•	•	•
	S034058100	34.00	58.00	10.00	X	•	•	•	•	•	•	•	•	•
	S034058130	34.00	58.00	13.00	X	•	X	•	•	•	•	•	•	•
	S034062100	34.00	62.00	10.00	X	•	X	•	•	•	•	•	•	•
	S034062120	34.00	62.00	12.00	•	•	X	•	•	•	•	•	•	•
	S034072100	34.00	72.00	10.00	X	•	X	X	•	•	•	•	•	•
	S034072120	34.00	72.00	12.00	•	•	•	•	•	•	•	•	•	•
	S034072145	34.00	72.00	14.50	•	•	•	•	X	•	•	•	•	•
	S035040050	35.00	40.00	5.00	•	•	•	•	•	•	•	•	X	•
	S035042019	35.00	42.00	1.90	•	•	•	•	•	•	•	X	•	•
	S035042035	35.00	42.00	3.50	•	•	•	•	•	•	•	X	•	•
	S035042040	35.00	42.00	4.00	X	•	•	•	•	•	•	•	X	•
	S035042080	35.00	42.00	8.00	X	•	•	X	•	•	•	•	X	•
	S035043050	35.00	43.00	5.00	•	•	•	•	•	•	•	•	X	•
	S035043060	35.00	43.00	6.00	X	•	•	•	•	•	•	•	•	•
	S035044070	35.00	44.00	7.00	•	•	•	•	X	•	•	•	•	•
	S035045040	35.00	45.00	4.00	•	•	•	•	•	•	•	X	X	•
	S035045050	35.00	45.00	5.00	X	X	•	•	•	•	•	•	•	•
	S035045060	35.00	45.00	6.00	X	•	•	•	X	•	X	•	•	•
	S035045070	35.00	45.00	7.00	X	X	•	X	X	•	•	•	•	•
	S035045080	35.00	45.00	8.00	•	•	•	X	•	•	•	•	•	•
	S035045100	35.00	45.00	10.00	X	•	•	•	•	•	•	•	•	•
	S035045120	35.00	45.00	12.00	X	•	•	X	•	X	•	•	•	•
	S035046065	35.00	46.00	6.50	X	•	•	•	•	•	•	•	•	•

X: EXISTING TOOLING    •: ON REQUEST

N.B.: MINIMUM LINE ORDER MAY APPLY

Tel.: (514) 334-2220  
Fax: (514) 333-8329

**SS 171**

[www.sealsonline.com](http://www.sealsonline.com)



**M**

## RADIAL SHAFT SEALS - NBR/STEEL

## GLOBAL AVAILABILITY LIST

Ref. Number	Dimensions			DESIGN TYPE									SC
	d	D	H	SC	SB2	SA2	TC	TB2	TA2	VB	VC	KB	
S035046070	35.00	46.00	7.00	•	•	•	X	•	•	•	•	•	•
S035046080	35.00	46.00	8.00	•	X	•	•	•	•	•	•	•	•
S035047040	35.00	47.00	4.00	•	•	•	•	•	•	•	X	•	•
S035047045	35.00	47.00	4.50	X	•	•	•	•	•	•	•	•	•
S035047050	35.00	47.00	5.00	X	X	•	•	•	•	X	•	•	•
S035047060	35.00	47.00	6.00	X	X	•	•	•	•	•	•	•	•
S035047070	35.00	47.00	7.00	X	X	X	X	X	•	•	•	•	•
S035047080	35.00	47.00	8.00	X	•	•	X	•	•	•	•	•	•
S035047090	35.00	47.00	9.00	•	•	•	X	•	•	•	•	•	•
S035047100	35.00	47.00	10.00	X	X	X	X	•	•	•	•	•	•
S035048050	35.00	48.00	5.00	•	•	•	•	•	•	X	•	•	•
S035048070	35.00	48.00	7.00	•	•	•	X	•	•	•	•	•	•
S035048080	35.00	48.00	8.00	X	•	•	X	X	•	•	•	•	•
S035048090	35.00	48.00	9.00	X	•	•	X	•	•	•	•	•	•
S035048100	35.00	48.00	10.00	•	•	•	X	•	•	•	•	•	•
S035048120	35.00	48.00	12.00	•	•	•	X	•	•	•	•	•	•
S035048150	35.00	48.00	15.00	•	•	•	X	•	•	•	•	•	•
S035050040	35.00	50.00	4.00	•	•	•	•	•	•	•	X	•	•
S035050050	35.00	50.00	5.00	X	•	•	•	•	•	•	X	•	•
S035050070	35.00	50.00	7.00	X	X	•	X	X	•	•	•	•	•
S035050080	35.00	50.00	8.00	X	X	•	X	•	•	•	X	•	•
S035050090	35.00	50.00	9.00	•	•	X	•	•	•	•	•	•	•
S035050100	35.00	50.00	10.00	X	X	X	X	X	X	•	•	•	•
S035050110	35.00	50.00	11.00	•	•	•	X	•	•	•	•	•	•
S035050120	35.00	50.00	12.00	•	X	X	X	X	X	•	•	•	•
S035051080	35.00	51.00	8.00	X	•	•	•	•	•	•	•	•	•
S035051090	35.00	51.00	9.00	•	•	•	X	•	•	•	•	•	•
S035051095	35.00	51.00	9.50	•	•	•	•	X	•	•	•	•	•
S035051120	35.00	51.00	12.00	•	•	•	X	•	X	•	•	•	•
S035051140	35.00	51.00	14.00	•	•	•	X	•	•	•	•	•	•
S035052060	35.00	52.00	6.00	•	•	•	X	•	•	•	•	•	•
S035052070	35.00	52.00	7.00	X	X	X	X	X	•	•	•	•	•
S035052080	35.00	52.00	8.00	X	•	•	X	•	•	•	•	•	•
S035052085	35.00	52.00	8.50	X	•	•	•	•	•	•	•	•	•
S035052087	35.00	52.00	8.70	•	X	•	•	•	•	•	•	•	•
S035052088	35.00	52.00	8.80	X	X	•	•	•	•	•	•	•	•
S035052090	35.00	52.00	9.00	X	X	X	X	X	X	•	•	•	•
S035052100	35.00	52.00	10.00	X	X	X	X	X	X	•	•	•	•
S035052110	35.00	52.00	11.00	•	•	•	X	•	•	•	•	•	•
S035052120	35.00	52.00	12.00	X	X	X	X	X	X	•	•	•	•
S035053080	35.00	53.00	8.00	X	•	•	•	•	•	•	•	•	•
S035054080	35.00	54.00	8.00	X	•	•	X	•	•	•	•	•	•
S035054095	35.00	54.00	9.50	•	•	•	X	•	•	•	•	•	•
S035054100	35.00	54.00	10.00	X	•	•	X	•	•	•	•	•	•
S035055050	35.00	55.00	5.00	X	•	•	•	•	•	•	X	X	•
S035055080	35.00	55.00	8.00	X	X	X	X	X	•	•	•	•	•
S035055090	35.00	55.00	9.00	•	•	•	X	•	•	•	•	•	•
S035055100	35.00	55.00	10.00	X	X	X	X	•	•	•	•	•	•

X: EXISTING TOOLING •: ON REQUEST



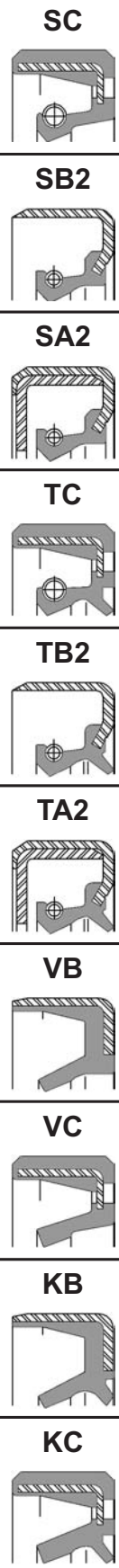







N.B.: MINIMUM LINE ORDER MAY APPLY

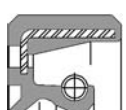

## GLOBAL AVAILABILITY LIST

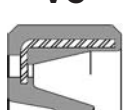
## RADIAL SHAFT SEALS - NBR/STEEL

METRIC SIZE  
SHAFT SEALS

SC 	Ref. Number	Dimensions			DESIGN TYPE									
		d	D	H	SC	SB2	SA2	TC	TB2	TA2	VB	VC	KB	KC
	S035055110	35.00	55.00	11.00	X	X	•	X	X	•	•	•	•	•
	S035055120	35.00	55.00	12.00	X	X	X	X	•	•	•	•	•	•
	S035056080	35.00	56.00	8.00	X	•	•	•	•	•	•	•	•	•
	S035056090	35.00	56.00	9.00	•	•	•	X	•	•	•	•	•	•
	S035056100	35.00	56.00	10.00	X	X	X	X	X	X	•	•	•	•
	S035056120	35.00	56.00	12.00	X	X	X	X	X	X	•	•	•	•
	S035057080	35.00	57.00	8.00	•	•	•	X	•	•	•	•	•	•
	S035057100	35.00	57.00	10.00	X	•	•	•	•	•	•	•	•	•
	S035058070	35.00	58.00	7.00	X	•	•	X	•	•	•	•	•	•
	S035058075	35.00	58.00	7.50	X	•	•	•	•	•	•	•	•	•
	S035058080	35.00	58.00	8.00	•	•	•	X	•	•	•	•	•	•
	S035058100	35.00	58.00	10.00	X	X	X	X	•	•	•	•	•	•
	S035058120	35.00	58.00	12.00	X	•	X	X	•	•	•	•	•	•
	S035058130	35.00	58.00	13.00	•	X	X	•	•	•	•	•	•	•
	S035060050	35.00	60.00	5.00	X	•	•	•	•	•	•	•	•	•
	S035060080	35.00	60.00	8.00	X	•	•	•	•	•	•	•	•	•
	S035060100	35.00	60.00	10.00	X	X	X	X	•	•	•	•	•	•
	S035060120	35.00	60.00	12.00	X	•	X	X	•	•	•	•	•	•
	S035062050	35.00	62.00	5.00	•	X	•	•	•	•	•	X	•	•
	S035062055	35.00	62.00	5.50	•	X	•	•	•	•	•	•	•	•
	S035062060	35.00	62.00	6.00	•	•	•	X	•	•	•	•	•	•
	S035062070	35.00	62.00	7.00	X	X	•	X	X	•	•	•	•	•
	S035062080	35.00	62.00	8.00	X	X	•	X	•	•	•	•	•	•
	S035062090	35.00	62.00	9.00	•	•	X	•	•	•	•	•	•	•
	S035062100	35.00	62.00	10.00	X	X	X	X	X	•	•	•	•	•
	S035062120	35.00	62.00	12.00	X	X	X	X	X	•	•	•	•	•
	S035062140	35.00	62.00	14.00	•	•	•	•	•	•	•	•	•	•
	S035064080	35.00	64.00	8.00	X	•	•	•	•	•	•	•	•	•
	S035064090	35.00	64.00	9.00	•	•	•	X	•	•	•	•	•	•
	S035064120	35.00	64.00	12.00	•	•	•	X	•	•	•	•	•	•
	S035064130	35.00	64.00	13.00	•	•	•	X	•	•	•	•	•	•
	S035065090	35.00	65.00	9.00	X	•	•	•	•	•	•	•	•	•
	S035065100	35.00	65.00	10.00	X	X	X	X	•	•	•	•	•	•
	S035065120	35.00	65.00	12.00	X	•	X	X	X	•	•	•	•	•
	S035067070	35.00	67.00	7.00	X	•	•	•	•	•	•	•	•	•
	S035068060	35.00	68.00	6.00	X	•	•	•	•	•	•	•	•	•
	S035068100	35.00	68.00	10.00	X	•	•	X	•	•	•	•	•	•
	S035068120	35.00	68.00	12.00	X	•	•	X	•	•	•	•	•	•
	S035070100	35.00	70.00	10.00	•	X	X	X	•	•	•	•	•	•
	S035070120	35.00	70.00	12.00	•	X	X	•	•	•	•	•	•	•
	S035072070	35.00	72.00	7.00	X	•	•	X	X	•	•	•	•	•
	S035072080	35.00	72.00	8.00	•	•	•	X	•	•	•	•	•	•
	S035072098	35.00	72.00	9.80	•	•	•	X	•	•	•	•	•	•
	S035072100	35.00	72.00	10.00	X	X	X	X	X	•	•	•	•	•
	S035072120	35.00	72.00	12.00	X	X	X	X	X	•	•	•	•	•
	S035076090	35.00	76.00	9.00	•	•	•	X	•	•	•	•	•	•
	S035078080	35.00	78.00	8.00	•	•	•	X	•	•	•	•	•	•
	S035080080	35.00	80.00	8.00	•	•	•	X	•	•	•	•	•	•

X: EXISTING TOOLING    •: ON REQUEST

N.B.: MINIMUM LINE ORDER MAY APPLY

Tel.: (888) 238-5885  
Fax: (888) 238-1664

**SS 173**

[www.sealsonline.com](http://www.sealsonline.com)



## RADIAL SHAFT SEALS - NBR/STEEL

## GLOBAL AVAILABILITY LIST

Ref. Number	Dimensions			DESIGN TYPE										SC 
	d	D	H	SC	SB2	SA2	TC	TB2	TA2	VB	VC	KB	KC	
S035080100	35.00	80.00	10.00	X	•	•	X	•	•	•	•	•	•	
S035080120	35.00	80.00	12.00	X	•	X	X	•	•	•	•	•	•	
S035080130	35.00	80.00	13.00	X	•	X	X	X	•	•	•	•	•	
S036044040	36.00	44.00	4.00	•	•	•	•	•	•	•	X	•	•	
S036044050	36.00	44.00	5.00	•	•	•	•	•	•	•	X	•	•	
S036047070	36.00	47.00	7.00	X	X	•	X	•	•	•	•	•	•	
S036048100	36.00	48.00	10.00	X	•	•	X	•	•	•	•	•	•	
S036048120	36.00	48.00	12.00	X	•	•	•	•	•	•	•	•	•	
S036050060	36.00	50.00	6.00	•	•	•	X	•	•	•	•	•	•	
S036050070	36.00	50.00	7.00	X	•	•	X	X	X	•	•	•	•	
S036050080	36.00	50.00	8.00	•	•	•	X	•	•	•	•	•	•	
S036050090	36.00	50.00	9.00	•	•	X	X	•	•	•	•	•	•	
S036050100	36.00	50.00	10.00	X	•	•	•	•	•	•	•	•	•	
S036051080	36.00	51.00	8.00	•	•	•	X	•	•	•	•	•	•	
S036051120	36.00	51.00	12.00	•	•	•	•	X	•	•	•	•	•	
S036052050	36.00	52.00	5.00	X	•	•	•	•	•	•	•	•	•	
S036052065	36.00	52.00	6.50	X	•	•	•	•	•	•	•	•	•	
S036052070	36.00	52.00	7.00	X	•	•	X	•	•	•	•	•	•	
S036052090	36.00	52.00	9.00	•	X	X	X	•	•	•	•	•	•	
S036052100	36.00	52.00	10.00	•	•	•	X	•	•	•	•	•	•	
S036053090	36.00	53.00	9.00	•	•	•	X	•	•	•	•	•	•	
S036054065	36.00	54.00	6.50	X	•	•	•	•	•	•	•	•	•	
S036054070	36.00	54.00	7.00	X	•	X	X	X	•	•	•	•	•	
S036054075	36.00	54.00	7.50	X	•	X	X	•	•	•	•	•	•	
S036054100	36.00	54.00	10.00	X	X	•	X	•	•	•	•	•	•	
S036054110	36.00	54.00	11.00	•	•	•	X	•	•	•	•	•	•	
S036055110	36.00	55.00	11.00	•	•	•	•	X	•	•	•	•	•	
S036056060	36.00	56.00	6.00	X	•	•	•	•	•	•	•	•	•	
S036056090	36.00	56.00	9.00	•	•	•	X	X	•	•	•	•	•	
S036056100	36.00	56.00	10.00	X	X	•	•	•	•	•	•	•	•	
S036056120	36.00	56.00	12.00	•	•	X	•	•	•	•	•	•	•	
S036058090	36.00	58.00	9.00	X	•	•	•	•	•	•	•	•	•	
S036058100	36.00	58.00	10.00	X	•	•	X	•	•	•	•	•	•	
S036058120	36.00	58.00	12.00	X	•	•	X	•	•	•	•	•	•	
S036059095	36.00	59.00	9.50	X	•	•	•	•	•	•	•	•	•	
S036060100	36.00	60.00	10.00	•	•	•	X	•	•	•	•	•	•	
S036062070	36.00	62.00	7.00	X	•	•	X	•	•	•	•	•	•	
S036062080	36.00	62.00	8.00	•	X	•	•	•	•	•	•	•	•	
S036062090	36.00	62.00	9.00	•	•	X	•	•	•	•	•	•	•	
S036062100	36.00	62.00	10.00	X	•	X	•	•	•	•	•	•	•	
S036062120	36.00	62.00	12.00	•	•	X	•	•	•	•	•	•	•	
S036063120	36.00	63.00	12.00	•	•	•	•	•	X	•	•	•	•	
S036065120	36.00	65.00	12.00	•	•	X	•	•	•	•	•	•	•	
S036068100	36.00	68.00	10.00	X	X	•	X	X	•	•	•	•	•	
S036072120	36.00	72.00	12.00	•	•	X	•	•	•	•	•	•	•	
S036075120	36.00	75.00	12.00	X	•	•	•	•	•	•	•	•	•	
S036083120	36.00	83.00	12.00	X	•	•	•	•	•	•	•	•	•	
S037047040	37.00	47.00	4.00	•	•	•	•	•	•	•	X	•	•	

X: EXISTING TOOLING •: ON REQUEST



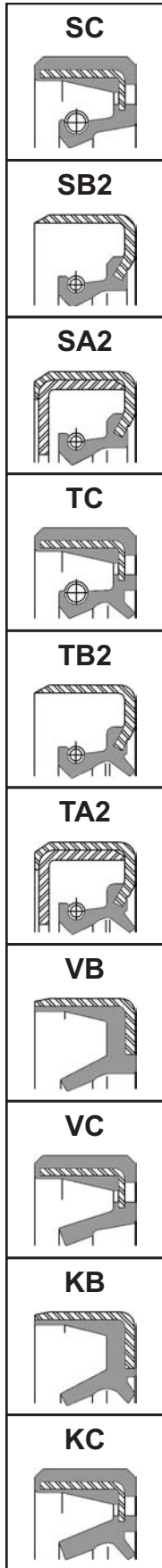











N.B.: MINIMUM LINE ORDER MAY APPLY

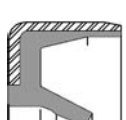
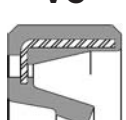
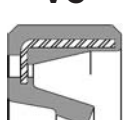

## GLOBAL AVAILABILITY LIST

## RADIAL SHAFT SEALS - NBR/STEEL

METRIC SIZE  
SHAFT SEALS

SC 	Ref. Number	Dimensions			DESIGN TYPE									
		d	D	H	SC	SB2	SA2	TC	TB2	TA2	VB	VC	KB	KC
	S037048060	37.00	48.00	6.00	•	•	•	X	•	•	•	•	•	•
	S037050070	37.00	50.00	7.00	•	•	•	X	•	•	•	•	•	•
	S037050100	37.00	50.00	10.00	X	•	•	•	•	•	•	•	•	•
	S037051080	37.00	51.00	8.00	•	•	•	•	X	•	•	•	•	•
	S037052070	37.00	52.00	7.00	X	•	•	•	•	•	•	•	•	•
	S037052080	37.00	52.00	8.00	X	•	•	•	•	•	•	•	•	•
	S037052100	37.00	52.00	10.00	X	•	X	X	•	•	•	•	•	•
	S037053070	37.00	53.00	7.00	•	•	•	X	•	•	•	•	•	•
	S037055080	37.00	55.00	8.00	•	•	•	X	•	•	•	•	•	•
	S037055090	37.00	55.00	9.00	•	•	X	•	•	•	•	•	•	•
	S037057100	37.00	57.00	10.00	•	X	•	•	•	•	•	•	•	•
	S037058130	37.00	58.00	13.00	X	•	X	•	•	•	•	•	•	•
	S037062070	37.00	62.00	7.00	•	•	•	X	•	•	•	•	•	•
	S037062080	37.00	62.00	8.00	X	•	X	•	•	•	•	•	•	•
	S037062090	37.00	62.00	9.00	•	•	X	•	•	•	•	•	•	•
	S037062100	37.00	62.00	10.00	X	•	•	•	•	•	•	•	•	•
	S037062110	37.00	62.00	11.00	X	•	•	•	•	•	•	•	•	•
	S037062120	37.00	62.00	12.00	X	•	X	•	•	•	•	•	•	•
	S037062140	37.00	62.00	14.00	•	•	•	•	X	X	•	•	•	•
	S037065100	37.00	65.00	10.00	X	•	•	•	•	•	•	•	•	•
	S037072120	37.00	72.00	12.00	X	•	•	•	•	•	•	•	•	•
	S037080130	37.00	80.00	13.00	•	•	X	•	•	•	•	•	•	•
	S038042030	38.00	42.00	3.00	•	•	•	•	•	•	X	•	•	•
	S038043030	38.00	43.00	3.00	•	•	•	•	•	•	X	•	•	•
	S038047090	38.00	47.00	9.00	•	•	•	•	•	•	X	•	•	•
	S038047100	38.00	47.00	10.00	•	•	•	X	•	•	•	•	•	•
	S038048040	38.00	48.00	4.00	•	•	•	•	•	•	•	X	•	•
	S038048060	38.00	48.00	6.00	X	•	•	X	•	•	•	X	•	•
	S038048070	38.00	48.00	7.00	X	•	•	•	•	•	•	•	•	•
	S038048100	38.00	48.00	10.00	•	•	•	X	•	•	•	•	•	•
	S038050070	38.00	50.00	7.00	X	X	•	X	•	•	•	•	•	•
	S038050080	38.00	50.00	8.00	X	X	•	X	•	•	•	•	•	•
	S038050100	38.00	50.00	10.00	X	•	•	X	•	•	•	•	•	•
	S038050110	38.00	50.00	11.00	•	•	•	X	•	•	•	•	•	•
	S038050120	38.00	50.00	12.00	•	•	•	X	•	•	•	•	•	•
	S038051075	38.00	51.00	7.50	•	•	•	X	•	•	•	•	•	•
	S038052060	38.00	52.00	6.00	•	•	•	X	•	•	•	•	•	•
	S038052070	38.00	52.00	7.00	X	X	•	X	X	•	•	•	•	•
	S038052080	38.00	52.00	8.00	X	X	•	X	•	X	•	•	•	•
	S038052085	38.00	52.00	8.50	•	•	•	X	•	•	•	•	•	•
	S038052090	38.00	52.00	9.00	X	•	•	X	•	•	•	•	•	•
	S038052095	38.00	52.00	9.50	•	•	•	X	•	•	•	•	•	•
	S038052100	38.00	52.00	10.00	X	X	X	X	•	•	•	•	•	•
	S038053050	38.00	53.00	5.00	•	•	•	•	•	•	•	X	•	•
	S038053080	38.00	53.00	8.00	X	•	•	•	•	•	•	•	•	•
	S038053100	38.00	53.00	10.00	•	•	•	X	•	•	•	•	•	•
	S038054060	38.00	54.00	6.00	•	•	•	•	X	•	•	•	•	•
	S038054065	38.00	54.00	6.50	X	•	•	•	•	•	•	•	•	•

X: EXISTING TOOLING    •: ON REQUEST

N.B.: MINIMUM LINE ORDER MAY APPLY

Tel.: (204) 783-9617  
Fax: (204) 783-6091

**SS 175**

[www.sealsonline.com](http://www.sealsonline.com)





## RADIAL SHAFT SEALS - NBR/STEEL

## GLOBAL AVAILABILITY LIST

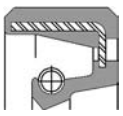
Ref. Number	Dimensions			DESIGN TYPE										SC 
	d	D	H	SC	SB2	SA2	TC	TB2	TA2	VB	VC	KB	KC	
S038054100	38.00	54.00	10.00	X	X	X	X	.	.	.	.	.	.	
S038054110	38.00	54.00	11.00	.	.	.	.	X	.	.	.	.	.	
S038055060	38.00	55.00	6.00	X	.	.	.	.	.	.	.	.	.	
S038055070	38.00	55.00	7.00	X	X	.	X	.	.	.	.	.	.	
S038055080	38.00	55.00	8.00	.	.	.	X	.	.	.	.	.	.	
S038055090	38.00	55.00	9.00	.	.	X	X	.	.	.	.	.	.	
S038055100	38.00	55.00	10.00	X	X	X	X	.	.	.	.	.	.	
S038055105	38.00	55.00	10.50	X	.	.	.	.	.	.	.	.	.	
S038055110	38.00	55.00	11.00	X	.	.	.	.	.	.	.	.	.	
S038055120	38.00	55.00	12.00	.	.	X	.	.	.	.	.	.	.	
S038056070	38.00	56.00	7.00	X	.	.	.	.	.	.	.	.	.	
S038056090	38.00	56.00	9.00	.	.	.	X	.	.	.	.	.	.	
S038056100	38.00	56.00	10.00	X	X	X	X	.	.	.	.	.	.	
S038056110	38.00	56.00	11.00	X	.	.	.	X	.	.	.	.	.	
S038056120	38.00	56.00	12.00	X	X	X	.	.	.	.	.	.	.	
S038057070	38.00	57.00	7.00	.	.	.	X	.	.	.	.	.	.	
S038057100	38.00	57.00	10.00	X	.	.	.	.	.	.	.	.	.	
S038058050	38.00	58.00	5.00	X	.	.	.	.	.	.	X	.	.	
S038058070	38.00	58.00	7.00	.	.	.	X	.	.	.	.	.	.	
S038058080	38.00	58.00	8.00	X	.	.	X	X	.	.	.	.	.	
S038058100	38.00	58.00	10.00	X	X	.	X	.	.	.	.	.	.	
S038058110	38.00	58.00	11.00	X	.	.	X	X	.	.	.	.	.	
S038058120	38.00	58.00	12.00	.	.	X	.	.	.	.	.	.	.	
S038059080	38.00	59.00	8.00	.	.	.	X	.	.	.	.	.	.	
S038060080	38.00	60.00	8.00	.	.	.	X	.	.	.	.	.	.	
S038060100	38.00	60.00	10.00	X	.	X	X	.	.	.	.	.	.	
S038060120	38.00	60.00	12.00	X	.	X	.	.	.	.	.	.	.	
S038060130	38.00	60.00	13.00	.	.	.	.	X	.	.	.	.	.	
S038062070	38.00	62.00	7.00	X	X	.	X	X	.	.	.	.	.	
S038062080	38.00	62.00	8.00	X	X	.	X	.	.	.	.	.	.	
S038062085	38.00	62.00	8.50	.	.	.	X	.	.	.	.	.	.	
S038062090	38.00	62.00	9.00	X	.	X	X	.	.	.	.	.	.	
S038062100	38.00	62.00	10.00	X	.	X	X	X	.	.	.	.	.	
S038062110	38.00	62.00	11.00	.	.	.	X	X	.	.	.	.	.	
S038062115	38.00	62.00	11.50	X	.	.	.	.	.	.	.	.	.	
S038062120	38.00	62.00	12.00	X	X	X	X	.	.	.	X	.	.	
S038063090	38.00	63.00	9.00	.	.	.	X	.	.	.	.	.	.	
S038064120	38.00	64.00	12.00	X	.	.	.	.	.	.	.	.	.	
S038065080	38.00	65.00	8.00	X	.	.	.	.	.	.	.	.	.	
S038065090	38.00	65.00	9.00	X	.	.	.	X	.	.	.	.	.	
S038065100	38.00	65.00	10.00	X	.	X	X	.	.	.	.	.	.	
S038065120	38.00	65.00	12.00	.	X	.	.	.	.	.	.	.	.	
S038068060	38.00	68.00	6.00	X	.	.	.	.	.	.	.	.	.	
S038068100	38.00	68.00	10.00	.	.	.	X	.	.	.	.	.	.	
S038070100	38.00	70.00	10.00	.	X	X	.	.	.	.	.	.	.	
S038070120	38.00	70.00	12.00	X	X	X	.	.	.	.	.	.	.	
S038072080	38.00	72.00	8.00	.	.	.	X	.	.	.	.	.	.	
S038072100	38.00	72.00	10.00	X	X	X	X	.	.	.	.	.	.	

X: EXISTING TOOLING    .: ON REQUEST

N.B.: MINIMUM LINE ORDER MAY APPLY



## GLOBAL AVAILABILITY LIST

## RADIAL SHAFT SEALS - NBR/STEEL

**METRIC SIZE  
SHAFT SEALS**

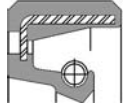
SC 	Ref. Number	Dimensions			DESIGN TYPE									
		d	D	H	SC	SB2	SA2	TC	TB2	TA2	VB	VC	KB	KC
	S038072120	38.00	72.00	12.00	X	X	X	•	•	•	•	•	•	•
	S038074100	38.00	74.00	10.00	X	X	•	•	•	•	•	•	•	•
	S038074110	38.00	74.00	11.00	•	•	•	X	X	•	•	•	•	•
	S038075050	38.00	75.00	5.00	X	•	•	•	•	•	•	•	•	•
	S038075100	38.00	75.00	10.00	•	•	•	X	•	•	•	•	•	•
	S038080100	38.00	80.00	10.00	X	•	•	•	•	•	•	•	•	•
	S038080120	38.00	80.00	12.00	X	•	•	•	•	•	•	•	•	•
	S038080130	38.00	80.00	13.00	•	•	X	•	•	•	•	•	•	•
	S039051075	39.00	51.00	7.50	X	•	•	•	•	•	•	•	•	•
	S039052065	39.00	52.00	6.50	X	•	•	•	•	•	•	•	•	•
	S039052080	39.00	52.00	8.00	X	•	•	•	•	•	•	•	•	•
	S039052100	39.00	52.00	10.00	•	•	•	X	•	•	•	•	•	•
	S039060080	39.00	60.00	8.00	•	•	•	X	•	•	•	•	•	•
	S039062120	39.00	62.00	12.00	•	•	X	•	•	•	•	•	•	•
	S039064090	39.00	64.00	9.00	•	•	•	X	•	•	•	•	•	•
	S039065090	39.00	65.00	9.00	X	•	•	•	•	•	•	•	•	•
	S040047040	40.00	47.00	4.00	•	•	•	•	X	•	•	X	•	•
	S040048030	40.00	48.00	3.00	•	•	•	•	•	•	X	•	•	•
	S040048040	40.00	48.00	4.00	•	•	•	•	•	•	X	X	•	•
	S040048060	40.00	48.00	6.00	•	•	•	•	•	•	X	•	•	•
	S040050040	40.00	50.00	4.00	•	•	•	•	•	•	X	X	•	•
	S040050050	40.00	50.00	5.00	X	•	•	X	•	•	•	•	•	•
	S040050060	40.00	50.00	6.00	•	•	•	•	•	•	X	•	•	•
	S040050065	40.00	50.00	6.50	•	•	•	X	•	•	•	•	•	•
	S040050070	40.00	50.00	7.00	X	•	X	X	•	•	•	•	•	•
	S040050080	40.00	50.00	8.00	X	•	•	X	•	•	•	•	•	•
	S040050090	40.00	50.00	9.00	X	•	•	•	•	•	•	•	•	•
	S040051055	40.00	51.00	5.50	X	•	•	•	•	•	•	•	•	•
	S040051060	40.00	51.00	6.00	•	•	•	X	•	•	•	•	•	•
	S040051100	40.00	51.00	10.00	•	•	•	X	•	•	•	•	•	•
	S040052050	40.00	52.00	5.00	X	•	•	X	•	•	•	X	•	•
	S040052060	40.00	52.00	6.00	X	•	•	X	•	•	•	•	•	•
	S040052070	40.00	52.00	7.00	X	X	•	X	X	X	•	•	•	•
	S040052080	40.00	52.00	8.00	X	X	X	X	•	•	•	•	•	•
	S040052085	40.00	52.00	8.50	X	•	•	X	•	•	•	•	•	•
	S040052090	40.00	52.00	9.00	•	•	•	X	•	•	•	•	•	•
	S040052100	40.00	52.00	10.00	X	•	•	X	•	•	•	•	•	•
	S040052120	40.00	52.00	12.00	•	X	•	•	•	•	•	•	•	•
	S040053070	40.00	53.00	7.00	•	•	•	•	X	•	•	•	•	•
	S040053085	40.00	53.00	8.50	X	•	•	•	•	•	•	•	•	•
	S040054050	40.00	54.00	5.00	•	•	•	X	•	•	•	X	•	•
	S040054055	40.00	54.00	5.50	•	•	•	X	X	•	•	•	•	•
	S040054070	40.00	54.00	7.00	X	•	•	X	X	•	•	X	•	•
	S040054075	40.00	54.00	7.50	•	•	•	X	•	•	•	•	•	•
	S040054110	40.00	54.00	11.00	•	•	•	•	•	X	•	•	•	•
	S040055050	40.00	55.00	5.00	•	•	•	•	•	•	•	X	•	•
	S040055060	40.00	55.00	6.00	•	•	•	•	X	•	X	•	•	•
	S040055065	40.00	55.00	6.50	X	•	•	•	•	•	•	•	•	•

X: EXISTING TOOLING    •: ON REQUEST

N.B.: MINIMUM LINE ORDER MAY APPLY

**Tel.: (780) 414-1871**  
**Fax: (780) 487-5419**

**SS 177**

**www.sealsonline.com**



**M**

## RADIAL SHAFT SEALS - NBR/STEEL

## GLOBAL AVAILABILITY LIST

Ref. Number	Dimensions			DESIGN TYPE									SC
	d	D	H	SC	SB2	SA2	TC	TB2	TA2	VB	VC	KB	
S040055070	40.00	55.00	7.00	X	X	•	X	X	•	•	•	•	•
S040055080	40.00	55.00	8.00	X	X	•	X	X	•	•	•	•	•
S040055090	40.00	55.00	9.00	•	•	X	X	X	•	•	•	•	•
S040055100	40.00	55.00	10.00	X	X	X	X	•	•	•	X	•	•
S040055120	40.00	55.00	12.00	X	X	X	X	•	X	•	•	•	•
S040056070	40.00	56.00	7.00	X	X	•	X	X	•	•	•	•	•
S040056080	40.00	56.00	8.00	X	•	•	X	•	•	•	•	•	•
S040056090	40.00	56.00	9.00	X	•	X	•	•	•	•	•	•	•
S040056100	40.00	56.00	10.00	X	X	X	X	•	•	•	•	•	•
S040056120	40.00	56.00	12.00	X	•	X	•	•	•	•	•	•	•
S040057100	40.00	57.00	10.00	•	•	•	X	•	•	•	•	•	•
S040058060	40.00	58.00	6.00	•	•	•	•	•	•	•	X	•	•
S040058070	40.00	58.00	7.00	X	•	•	•	•	•	•	•	•	•
S040058080	40.00	58.00	8.00	X	•	•	X	•	•	•	•	•	•
S040058085	40.00	58.00	8.50	•	•	•	X	•	•	•	•	•	•
S040058089	40.00	58.00	8.90	•	•	•	X	•	•	•	•	•	•
S040058090	40.00	58.00	9.00	X	X	X	X	•	•	•	•	•	•
S040058100	40.00	58.00	10.00	X	X	X	X	•	•	•	•	•	•
S040058120	40.00	58.00	12.00	X	X	X	•	•	•	•	•	•	•
S040059095	40.00	59.00	9.50	•	•	•	X	•	•	•	•	•	•
S040060070	40.00	60.00	7.00	X	•	•	X	•	•	•	•	•	•
S040060080	40.00	60.00	8.00	X	•	•	X	•	•	•	•	•	•
S040060090	40.00	60.00	9.00	•	•	•	X	•	•	•	•	•	•
S040060100	40.00	60.00	10.00	X	X	X	X	X	X	•	•	•	•
S040060120	40.00	60.00	12.00	X	X	X	X	X	•	•	•	•	•
S040061100	40.00	61.00	10.00	X	•	•	•	•	•	•	•	•	•
S040062050	40.00	62.00	5.00	X	•	•	•	•	•	•	X	•	•
S040062065	40.00	62.00	6.50	X	•	•	•	•	•	•	•	•	•
S040062070	40.00	62.00	7.00	X	X	•	X	X	•	•	•	•	•
S040062080	40.00	62.00	8.00	X	X	X	X	X	•	•	•	•	•
S040062090	40.00	62.00	9.00	•	•	X	X	•	X	•	•	•	•
S040062100	40.00	62.00	10.00	X	X	X	X	X	X	•	•	•	•
S040062110	40.00	62.00	11.00	•	X	•	X	X	•	•	•	•	•
S040062115	40.00	62.00	11.50	X	•	•	X	•	•	•	•	•	•
S040062120	40.00	62.00	12.00	X	X	X	X	X	•	•	•	•	•
S040062130	40.00	62.00	13.00	•	•	•	•	•	•	•	•	•	•
S040062140	40.00	62.00	14.00	•	•	•	X	•	•	•	•	•	•
S040063060	40.00	63.00	6.00	X	•	•	•	•	•	•	•	•	•
S040063070	40.00	63.00	7.00	•	•	•	X	•	•	•	•	•	•
S040063100	40.00	63.00	10.00	X	•	•	•	•	•	•	•	•	•
S040064100	40.00	64.00	10.00	•	•	•	X	•	•	•	•	•	•
S040064120	40.00	64.00	12.00	•	•	•	X	•	•	•	•	•	•
S040065080	40.00	65.00	8.00	•	•	•	X	•	•	•	•	•	•
S040065090	40.00	65.00	9.00	X	X	•	X	•	•	•	•	•	•
S040065100	40.00	65.00	10.00	X	X	X	X	X	X	•	•	•	•
S040065120	40.00	65.00	12.00	X	X	X	X	X	X	•	•	•	•
S040065130	40.00	65.00	13.00	•	•	•	X	•	•	•	•	•	•
S040065140	40.00	65.00	14.00	•	•	•	X	•	•	•	•	•	•

X: EXISTING TOOLING •: ON REQUEST

N.B.: MINIMUM LINE ORDER MAY APPLY

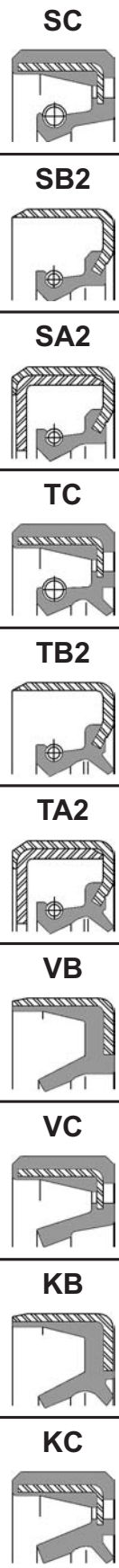

## GLOBAL AVAILABILITY LIST

## RADIAL SHAFT SEALS - NBR/STEEL

METRIC SIZE  
SHAFT SEALS

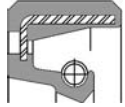
SC 	Ref. Number	Dimensions			DESIGN TYPE									
		d	D	H	SC	SB2	SA2	TC	TB2	TA2	VB	VC	KB	KC
	S040065200	40.00	65.00	20.00	•	•	•	•	•	•	•	•	•	•
	S040067080	40.00	67.00	8.00	•	X	•	X	•	•	•	•	•	•
	S040068060	40.00	68.00	6.00	X	•	•	•	•	•	•	•	•	•
	S040068070	40.00	68.00	7.00	X	X	•	X	•	•	•	•	•	•
	S040068080	40.00	68.00	8.00	X	•	•	•	•	•	•	•	•	•
	S040068100	40.00	68.00	10.00	X	X	X	X	•	•	•	•	•	•
	S040068110	40.00	68.00	11.00	X	•	•	X	X	•	•	•	•	•
	S040068120	40.00	68.00	12.00	X	X	X	X	•	•	•	•	•	•
	S040069090	40.00	69.00	9.00	•	•	•	X	•	•	•	•	•	•
	S040070080	40.00	70.00	8.00	X	•	•	X	•	•	•	•	•	•
	S040070100	40.00	70.00	10.00	X	X	•	X	•	•	•	•	•	•
	S040070120	40.00	70.00	12.00	X	•	X	•	•	•	•	•	•	•
	S040072070	40.00	72.00	7.00	X	X	•	X	•	•	•	•	•	•
	S040072080	40.00	72.00	8.00	X	•	•	X	•	•	•	•	•	•
	S040072090	40.00	72.00	9.00	•	X	X	•	•	•	•	•	•	•
	S040072100	40.00	72.00	10.00	X	X	X	X	•	X	•	•	•	•
	S040072120	40.00	72.00	12.00	X	X	X	X	•	•	•	•	•	•
	S040075070	40.00	75.00	7.00	X	•	•	•	•	•	•	•	•	•
	S040075100	40.00	75.00	10.00	•	•	•	X	•	•	•	•	•	•
	S040075120	40.00	75.00	12.00	•	•	•	X	•	•	•	•	•	•
	S040078100	40.00	78.00	10.00	X	•	X	•	•	•	•	•	•	•
	S040080070	40.00	80.00	7.00	•	•	•	X	•	•	•	•	•	•
	S040080080	40.00	80.00	8.00	X	•	•	X	•	•	•	•	•	•
	S040080100	40.00	80.00	10.00	X	X	X	X	X	•	•	•	•	•
	S040080120	40.00	80.00	12.00	X	X	•	X	•	•	•	•	•	•
	S040080130	40.00	80.00	13.00	X	•	X	X	•	X	•	•	•	•
	S040085100	40.00	85.00	10.00	X	•	X	•	•	•	•	•	•	•
	S040090080	40.00	90.00	8.00	X	•	X	•	•	•	•	•	•	•
	S040090090	40.00	90.00	9.00	•	•	X	X	•	•	•	•	•	•
	S040090100	40.00	90.00	10.00	X	•	•	X	•	•	•	•	•	•
	S040090120	40.00	90.00	12.00	X	X	X	X	•	•	•	•	•	•
	S040090130	40.00	90.00	13.00	•	•	X	•	•	•	•	•	•	•
	S040095100	40.00	95.00	10.00	•	•	X	•	•	•	•	•	•	•
	S040110120	40.00	110.00	12.00	X	•	•	•	•	•	•	•	•	•
	S041047040	41.00	47.00	4.00	•	•	•	•	•	•	•	X	•	•
	S041052055	41.00	52.00	5.50	•	•	•	•	•	•	X	•	•	•
	S041052070	41.00	52.00	7.00	•	•	•	X	•	•	•	•	•	•
	S041052080	41.00	52.00	8.00	X	•	•	•	•	•	•	•	•	•
	S041053070	41.00	53.00	7.00	•	•	•	X	X	X	•	•	•	•
	S041053080	41.00	53.00	8.00	•	•	•	X	•	•	•	•	•	•
	S041055060	41.00	55.00	6.00	•	•	•	•	X	•	•	•	•	•
	S041055070	41.00	55.00	7.00	•	•	•	X	•	•	•	•	•	•
	S041055085	41.00	55.00	8.50	X	•	•	•	•	•	•	•	•	•
	S041055090	41.00	55.00	9.00	•	•	•	X	X	•	•	•	•	•
	S041056070	41.00	56.00	7.00	X	X	•	X	•	•	•	•	•	•
	S041056074	41.00	56.00	7.40	X	•	•	•	•	•	•	•	•	•
	S041056080	41.00	56.00	8.00	X	•	•	X	•	•	•	•	•	•
	S041056090	41.00	56.00	9.00	•	•	•	•	X	•	•	•	•	•

X: EXISTING TOOLING    •: ON REQUEST

N.B.: MINIMUM LINE ORDER MAY APPLY

Tel.: (604) 278-6808  
Fax: (604) 278-6180

**SS 179**

[www.sealsonline.com](http://www.sealsonline.com)



**M**

**METRIC SIZE  
SHAFT SEALS**



## RADIAL SHAFT SEALS - NBR/STEEL

## GLOBAL AVAILABILITY LIST

Ref. Number	Dimensions			DESIGN TYPE									SC
	d	D	H	SC	SB2	SA2	TC	TB2	TA2	VB	VC	KB	
S041056100	41.00	56.00	10.00	X	X	•	X	•	•	•	•	•	•
S041060100	41.00	60.00	10.00	•	•	•	•	X	•	•	•	•	•
S041062100	41.00	62.00	10.00	•	•	X	•	•	•	•	•	•	•
S041063060	41.00	63.00	6.00	X	•	•	•	•	•	•	•	•	•
S042047060	42.00	47.00	6.00	•	•	•	•	•	•	X	•	•	•
S042050070	42.00	50.00	7.00	X	•	•	•	•	•	•	•	•	•
S042050100	42.00	50.00	10.00	X	•	•	•	•	•	•	X	•	•
S042052040	42.00	52.00	4.00	•	•	•	X	•	•	•	X	•	•
S042052050	42.00	52.00	5.00	X	•	•	•	•	•	•	•	•	•
S042052055	42.00	52.00	5.50	•	•	•	•	•	•	•	X	•	•
S042052080	42.00	52.00	8.00	X	•	•	X	•	•	•	•	•	•
S042052100	42.00	52.00	10.00	•	X	•	•	•	•	•	•	•	•
S042053070	42.00	53.00	7.00	•	•	•	X	•	•	•	•	•	•
S042054050	42.00	54.00	5.00	•	•	•	X	•	•	•	•	•	•
S042055050	42.00	55.00	5.00	•	•	•	X	•	•	•	•	•	•
S042055060	42.00	55.00	6.00	•	•	•	X	X	•	•	•	•	•
S042055070	42.00	55.00	7.00	X	X	•	X	X	•	•	•	•	•
S042055080	42.00	55.00	8.00	X	X	•	X	•	•	•	•	•	•
S042055090	42.00	55.00	9.00	X	X	•	X	X	•	•	•	•	•
S042055100	42.00	55.00	10.00	X	•	•	X	X	•	•	•	•	•
S042055120	42.00	55.00	12.00	•	•	•	X	•	•	•	•	•	•
S042056050	42.00	56.00	5.00	X	•	•	•	•	•	•	•	•	•
S042056060	42.00	56.00	6.00	X	•	•	•	•	•	•	•	•	•
S042056070	42.00	56.00	7.00	X	X	•	X	X	•	•	•	•	•
S042056080	42.00	56.00	8.00	•	X	•	•	•	•	•	•	•	•
S042056100	42.00	56.00	10.00	•	•	•	X	X	•	•	•	•	•
S042057070	42.00	57.00	7.00	X	•	•	•	•	•	•	•	•	•
S042057080	42.00	57.00	8.00	•	•	•	•	X	•	•	•	•	•
S042057140	42.00	57.00	14.00	•	•	•	X	•	•	•	•	•	•
S042058070	42.00	58.00	7.00	X	X	•	X	X	•	•	•	•	•
S042058080	42.00	58.00	8.00	X	•	•	X	•	•	•	•	•	•
S042058090	42.00	58.00	9.00	•	X	•	•	•	•	•	•	•	•
S042058100	42.00	58.00	10.00	X	X	•	X	•	•	•	•	•	•
S042058120	42.00	58.00	12.00	X	•	•	•	•	•	•	•	•	•
S042060070	42.00	60.00	7.00	X	•	•	X	•	•	X	•	•	•
S042060080	42.00	60.00	8.00	X	•	•	X	•	•	•	•	•	•
S042060090	42.00	60.00	9.00	X	X	•	X	•	•	•	•	•	•
S042060100	42.00	60.00	10.00	X	X	X	X	•	•	•	•	•	•
S042060120	42.00	60.00	12.00	X	•	X	•	•	•	•	•	•	•
S042062070	42.00	62.00	7.00	X	X	•	X	X	•	•	•	•	•
S042062080	42.00	62.00	8.00	X	X	•	X	•	•	•	•	•	•
S042062090	42.00	62.00	9.00	•	•	•	X	•	•	•	•	•	•
S042062100	42.00	62.00	10.00	X	X	X	X	X	X	•	•	•	•
S042062110	42.00	62.00	11.00	•	•	•	X	•	•	•	•	•	•
S042062120	42.00	62.00	12.00	X	X	X	•	•	•	•	•	•	•
S042064070	42.00	64.00	7.00	X	•	•	•	•	•	•	•	•	•
S042065080	42.00	65.00	8.00	X	•	X	X	•	•	•	•	•	•
S042065090	42.00	65.00	9.00	•	•	•	X	X	•	•	•	•	•

X: EXISTING TOOLING    ••: ON REQUEST



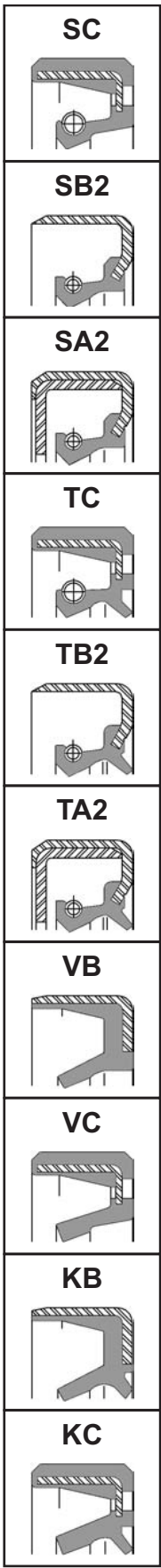







N.B.: MINIMUM LINE ORDER MAY APPLY

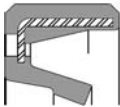

## GLOBAL AVAILABILITY LIST

## RADIAL SHAFT SEALS - NBR/STEEL

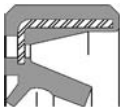
METRIC SIZE  
SHAFT SEALS

SC 	Ref. Number	Dimensions			DESIGN TYPE									
		d	D	H	SC	SB2	SA2	TC	TB2	TA2	VB	VC	KB	KC
	S042065100	42.00	65.00	10.00	X	X	X	X	•	X	•	•	•	•
	S042065120	42.00	65.00	12.00	X	X	X	X	•	•	•	•	•	•
	S042065130	42.00	65.00	13.00	•	•	•	X	X	•	•	•	•	•
	S042066130	42.00	66.00	13.00	•	•	X	•	•	•	•	•	•	•
	S042067100	42.00	67.00	10.00	•	X	•	X	•	•	•	•	•	•
	S042068100	42.00	68.00	10.00	•	•	X	X	•	•	•	•	•	•
	S042068110	42.00	68.00	11.00	X	•	•	•	•	•	•	•	•	•
	S042068115	42.00	68.00	11.50	X	•	•	•	•	•	•	•	•	•
	S042068120	42.00	68.00	12.00	•	•	•	X	•	•	•	•	•	•
	S042070080	42.00	70.00	8.00	X	•	•	•	•	•	•	•	•	•
	S042070100	42.00	70.00	10.00	X	X	X	X	•	•	•	•	•	•
	S042070120	42.00	70.00	12.00	X	•	X	X	•	•	•	•	•	•
	S042072060	42.00	72.00	6.00	•	•	•	X	•	•	•	•	•	•
	S042072080	42.00	72.00	8.00	X	•	•	X	•	•	•	•	•	•
	S042072090	42.00	72.00	9.00	•	•	•	X	•	•	•	•	•	•
	S042072100	42.00	72.00	10.00	X	X	X	X	X	•	•	•	•	•
	S042072120	42.00	72.00	12.00	X	X	X	•	•	•	•	•	•	•
	S042075100	42.00	75.00	10.00	•	•	•	X	•	•	•	•	•	•
	S042075120	42.00	75.00	12.00	•	•	•	X	•	•	•	•	•	•
	S042076120	42.00	76.00	12.00	•	•	•	X	•	•	•	•	•	•
	S042080100	42.00	80.00	10.00	X	•	•	•	•	•	•	•	•	•
	S042080120	42.00	80.00	12.00	•	•	X	•	•	•	•	•	•	•
	S042080130	42.00	80.00	13.00	•	•	X	•	•	•	•	•	•	•
	S042081130	42.00	81.00	13.00	X	•	•	•	•	•	•	•	•	•
	S043052100	43.00	52.00	10.00	•	•	X	•	•	•	•	•	•	•
	S043053040	43.00	53.00	4.00	•	•	•	•	•	•	•	X	•	•
	S043053050	43.00	53.00	5.00	X	•	•	•	•	•	•	•	•	•
	S043054070	43.00	54.00	7.00	•	•	•	X	•	•	•	•	•	•
	S043054075	43.00	54.00	7.50	X	•	•	X	X	•	•	•	•	•
	S043054090	43.00	54.00	9.00	•	•	•	X	•	•	•	•	•	•
	S043055070	43.00	55.00	7.00	X	•	•	•	•	•	•	•	•	•
	S043055080	43.00	55.00	8.00	•	•	•	X	•	•	•	•	•	•
	S043055090	43.00	55.00	9.00	•	•	•	X	•	•	•	•	•	•
	S043058070	43.00	58.00	7.00	•	•	•	X	•	•	•	•	•	•
	S043059050	43.00	59.00	5.00	X	•	•	•	•	•	•	•	•	•
	S043059080	43.00	59.00	8.00	•	•	•	X	•	•	•	•	•	•
	S043060100	43.00	60.00	10.00	X	•	•	•	•	•	•	•	•	•
	S043061090	43.00	61.00	9.00	•	X	•	•	X	•	•	•	•	•
	S043062080	43.00	62.00	8.00	•	•	•	X	•	•	•	•	•	•
	S043062100	43.00	62.00	10.00	X	•	•	•	•	•	•	•	•	•
	S043062120	43.00	62.00	12.00	•	•	•	X	•	•	•	•	•	•
	S043063095	43.00	63.00	9.50	•	X	•	•	•	•	•	•	•	•
	S043065080	43.00	65.00	8.00	X	•	•	•	•	•	•	•	•	•
	S043066100	43.00	66.00	10.00	X	•	•	X	•	•	•	•	•	•
	S043066120	43.00	66.00	12.00	X	•	•	•	•	•	•	•	•	•
	S043068120	43.00	68.00	12.00	•	•	•	X	•	•	•	•	•	•
	S043070100	43.00	70.00	10.00	•	•	•	X	•	•	•	•	•	•
	S043072100	43.00	72.00	10.00	•	•	X	•	•	•	•	•	•	•

X: EXISTING TOOLING    •: ON REQUEST

N.B.: MINIMUM LINE ORDER MAY APPLY

Tel.: (418) 688-3202  
Fax: (418) 688-4272

**SS 181**

[www.sealsonline.com](http://www.sealsonline.com)



**M**

## RADIAL SHAFT SEALS - NBR/STEEL

## GLOBAL AVAILABILITY LIST

Ref. Number	Dimensions			DESIGN TYPE										SC 
	d	D	H	SC	SB2	SA2	TC	TB2	TA2	VB	VC	KB	KC	
S043072120	43.00	72.00	12.00	•	•	X	•	•	•	•	•	•	•	
S043073100	43.00	73.00	10.00	•	•	•	X	•	•	•	•	•	•	
S043075100	43.00	75.00	10.00	X	•	•	•	•	•	•	•	•	•	
S043080100	43.00	80.00	10.00	X	•	•	•	•	•	•	•	•	•	
S044052100	44.00	52.00	10.00	X	•	•	•	•	•	•	X	•	•	
S044054045	44.00	54.00	4.50	X	•	•	X	•	•	•	•	•	•	
S044054070	44.00	54.00	7.00	•	•	•	X	•	•	•	•	•	•	
S044054075	44.00	54.00	7.50	X	•	•	•	•	•	•	•	•	•	
S044055050	44.00	55.00	5.00	X	•	•	•	•	•	•	•	•	•	
S044055060	44.00	55.00	6.00	X	•	•	•	•	•	•	•	•	•	
S044055070	44.00	55.00	7.00	X	•	•	•	•	•	•	•	•	•	
S044055100	44.00	55.00	10.00	•	•	•	•	•	•	•	•	•	•	
S044056070	44.00	56.00	7.00	•	X	•	•	•	•	•	•	•	•	
S044058070	44.00	58.00	7.00	•	X	•	•	•	•	•	•	•	•	
S044058090	44.00	58.00	9.00	•	•	•	X	•	•	•	•	•	•	
S044060060	44.00	60.00	6.00	•	X	•	•	•	•	•	•	•	•	
S044060070	44.00	60.00	7.00	•	•	•	X	X	•	•	•	•	•	
S044060090	44.00	60.00	9.00	X	•	•	X	•	•	•	•	•	•	
S044060100	44.00	60.00	10.00	X	X	X	X	•	•	•	•	•	•	
S044060120	44.00	60.00	12.00	•	•	•	X	•	•	•	•	•	•	
S044061080	44.00	61.00	8.00	•	•	•	X	•	•	•	•	•	•	
S044061100	44.00	61.00	10.00	•	•	•	X	•	•	•	•	•	•	
S044062080	44.00	62.00	8.00	X	•	•	X	•	•	•	•	•	•	
S044062090	44.00	62.00	9.00	•	•	•	X	•	•	•	•	•	•	
S044062100	44.00	62.00	10.00	X	X	•	X	•	•	•	•	•	•	
S044062115	44.00	62.00	11.50	•	•	•	X	•	•	•	•	•	•	
S044062120	44.00	62.00	12.00	•	X	X	•	•	•	•	•	•	•	
S044064090	44.00	64.00	9.00	•	•	•	X	•	•	•	•	•	•	
S044065080	44.00	65.00	8.00	•	•	•	X	•	•	•	•	•	•	
S044065100	44.00	65.00	10.00	X	X	•	•	X	•	•	•	•	•	
S044065110	44.00	65.00	11.00	•	•	•	X	•	•	•	•	•	•	
S044065120	44.00	65.00	12.00	•	•	X	•	•	•	•	•	•	•	
S044066060	44.00	66.00	6.00	X	•	•	•	•	•	•	•	•	•	
S044066130	44.00	66.00	13.00	X	•	•	•	•	•	•	•	•	•	
S044069110	44.00	69.00	11.00	•	•	•	X	•	•	•	•	•	•	
S044070100	44.00	70.00	10.00	X	•	•	•	•	•	•	•	•	•	
S044070120	44.00	70.00	12.00	X	•	X	X	•	•	•	•	•	•	
S044072100	44.00	72.00	10.00	X	•	X	•	•	•	•	•	•	•	
S044072120	44.00	72.00	12.00	•	•	X	•	•	•	•	•	•	•	
S044073120	44.00	73.00	12.00	X	•	•	•	•	•	•	•	•	•	
S044078120	44.00	78.00	12.00	X	•	•	•	•	•	•	•	•	•	
S044100120	44.00	100.00	12.00	X	•	•	•	•	•	•	•	•	•	
S045050030	45.00	50.00	3.00	•	•	•	•	•	•	X	•	•	•	
S045050050	45.00	50.00	5.00	X	•	•	•	•	•	•	•	•	•	
S045052040	45.00	52.00	4.00	•	•	•	•	•	•	X	X	•	•	
S045052080	45.00	52.00	8.00	X	•	•	•	•	•	•	•	•	•	
S045054045	45.00	54.00	4.50	•	•	•	X	•	•	•	•	•	•	
S045054064	45.00	54.00	6.40	•	X	•	•	•	•	•	•	•	•	

X: EXISTING TOOLING •: ON REQUEST









N.B.: MINIMUM LINE ORDER MAY APPLY

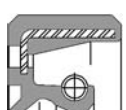

## GLOBAL AVAILABILITY LIST

## RADIAL SHAFT SEALS - NBR/STEEL

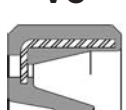
METRIC SIZE  
SHAFT SEALS

SC 	Ref. Number	Dimensions			DESIGN TYPE										
		d	D	H	SC	SB2	SA2	TC	TB2	TA2	VB	VC	KB	KC	
	S045055040	45.00	55.00	4.00	•	•	•	•	•	•	•	•	X	•	•
	S045055050	45.00	55.00	5.00	•	•	•	•	•	•	•	X	•	•	•
	S045055060	45.00	55.00	6.00	•	•	•	•	•	•	•	X	•	•	•
SB2 	S045055070	45.00	55.00	7.00	X	X	•	X	•	•	•	•	•	•	•
	S045055080	45.00	55.00	8.00	X	X	•	•	•	•	•	•	•	•	•
	S045055100	45.00	55.00	10.00	X	•	•	•	•	•	•	•	•	•	•
SA2 	S045056060	45.00	56.00	6.00	X	•	•	•	•	•	•	•	•	•	•
	S045056070	45.00	56.00	7.00	X	•	•	X	•	•	•	•	•	•	•
	S045057040	45.00	57.00	4.00	•	X	•	•	•	•	•	X	•	•	•
	S045057055	45.00	57.00	5.50	•	•	•	X	•	•	•	•	•	•	•
	S045057070	45.00	57.00	7.00	X	•	•	X	•	•	•	•	•	•	•
	S045057075	45.00	57.00	7.50	X	•	•	X	•	•	•	•	•	•	•
TC 	S045057100	45.00	57.00	10.00	•	•	•	X	•	•	•	•	•	•	•
	S045058070	45.00	58.00	7.00	X	•	•	X	•	•	•	•	•	•	•
	S045058080	45.00	58.00	8.00	X	•	•	•	•	•	•	•	•	•	•
	S045058090	45.00	58.00	9.00	•	X	•	•	X	•	•	•	•	•	•
	S045058120	45.00	58.00	12.00	•	•	•	X	•	•	•	•	•	•	•
	S045059080	45.00	59.00	8.00	X	•	•	•	•	•	•	•	•	•	•
TB2 	S045059100	45.00	59.00	10.00	•	•	•	X	•	•	•	•	•	•	•
	S045060050	45.00	60.00	5.00	•	•	•	X	•	•	•	•	•	•	•
	S045060060	45.00	60.00	6.00	•	•	•	•	•	•	•	•	X	•	•
	S045060065	45.00	60.00	6.50	X	•	•	•	•	•	•	•	•	•	•
	S045060070	45.00	60.00	7.00	X	X	•	X	•	•	•	•	•	•	•
TA2 	S045060080	45.00	60.00	8.00	X	X	•	X	•	•	•	•	•	•	•
	S045060090	45.00	60.00	9.00	•	X	•	X	•	•	•	•	•	•	•
	S045060100	45.00	60.00	10.00	X	X	X	X	X	•	•	•	•	•	•
	S045060120	45.00	60.00	12.00	X	•	X	X	•	•	•	•	•	•	•
	S045061090	45.00	61.00	9.00	X	•	•	X	•	•	•	•	•	•	•
VB 	S045061100	45.00	61.00	10.00	•	X	•	•	X	•	•	•	•	•	•
	S045062070	45.00	62.00	7.00	X	X	•	X	X	•	•	•	•	•	•
	S045062075	45.00	62.00	7.50	•	•	•	X	•	•	•	•	•	•	•
	S045062080	45.00	62.00	8.00	X	X	•	X	X	•	•	•	•	•	•
	S045062085	45.00	62.00	8.50	•	•	•	X	•	•	•	•	•	•	•
VC 	S045062090	45.00	62.00	9.00	X	X	•	X	X	•	•	•	•	•	•
	S045062100	45.00	62.00	10.00	X	X	X	X	X	X	•	•	•	•	•
	S045062110	45.00	62.00	11.00	•	•	•	X	•	•	•	•	•	•	•
	S045062120	45.00	62.00	12.00	X	X	X	X	X	X	•	•	•	•	•
	S045062140	45.00	62.00	14.00	•	•	•	•	•	•	•	•	•	•	•
KB 	S045063070	45.00	63.00	7.00	•	•	•	•	X	•	•	•	•	•	•
	S045064080	45.00	64.00	8.00	•	•	•	X	•	•	•	•	•	•	•
	S045064095	45.00	64.00	9.50	X	•	•	•	•	•	•	•	•	•	•
	S045064120	45.00	64.00	12.00	•	•	•	•	•	•	X	•	•	•	•
KC 	S045065050	45.00	65.00	5.00	•	•	•	X	•	•	X	•	•	•	•
	S045065060	45.00	65.00	6.00	X	•	•	•	•	•	•	•	•	•	•
	S045065070	45.00	65.00	7.00	X	•	•	•	•	•	•	•	•	•	•
	S045065080	45.00	65.00	8.00	X	X	•	X	X	•	•	•	•	•	•
	S045065090	45.00	65.00	9.00	X	•	•	•	•	•	•	•	•	•	•
	S045065100	45.00	65.00	10.00	X	X	X	X	X	•	•	•	•	•	•

X: EXISTING TOOLING    •: ON REQUEST

N.B.: MINIMUM LINE ORDER MAY APPLY

Tel.: (514) 334-2220  
Fax: (514) 333-8329

**SS 183**

[www.sealsonline.com](http://www.sealsonline.com)



**M**

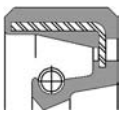

## RADIAL SHAFT SEALS - NBR/STEEL

Ref. Number	Dimensions			DESIGN TYPE										SC 
	d	D	H	SC	SB2	SA2	TC	TB2	TA2	VB	VC	KB	KC	
S045065120	45.00	65.00	12.00	X	X	X	X	X	X	.	.	.	.	
S045066060	45.00	66.00	6.00	X	.	.	.	.	.	.	.	.	.	
S045066090	45.00	66.00	9.00	X	.	.	.	.	.	.	.	.	.	
S045066100	45.00	66.00	10.00	X	.	.	.	.	.	.	.	.	.	
S045068050	45.00	68.00	5.00	.	.	.	.	.	.	.	X	.	.	
S045068080	45.00	68.00	8.00	X	.	.	X	.	.	.	.	.	.	
S045068090	45.00	68.00	9.00	.	.	.	X	.	.	.	.	.	.	
S045068100	45.00	68.00	10.00	X	X	X	X	.	.	.	.	.	.	
S045068108	45.00	68.00	10.80	X	.	.	.	.	.	.	.	.	.	
S045068120	45.00	68.00	12.00	X	X	X	X	X	.	.	.	.	.	
S045068125	45.00	68.00	12.50	X	.	.	.	.	.	.	.	.	.	
S045068140	45.00	68.00	14.00	.	.	.	X	.	.	.	.	.	.	
S045069090	45.00	69.00	9.00	.	.	.	.	.	.	X	.	.	.	
S045070050	45.00	70.00	5.00	.	.	.	X	.	.	.	.	.	.	
S045070100	45.00	70.00	10.00	X	X	X	X	.	.	.	.	.	.	
S045070120	45.00	70.00	12.00	X	X	X	X	.	.	.	.	.	.	
S045070140	45.00	70.00	14.00	X	.	.	.	.	.	.	.	.	.	
S045071065	45.00	71.00	6.50	.	.	.	X	.	.	.	.	.	.	
S045072070	45.00	72.00	7.00	X	X	.	.	.	.	.	.	.	.	
S045072080	45.00	72.00	8.00	X	X	.	X	X	.	.	.	.	.	
S045072090	45.00	72.00	9.00	X	.	.	.	.	.	.	.	.	.	
S045072100	45.00	72.00	10.00	X	X	X	X	.	.	.	.	.	.	
S045072120	45.00	72.00	12.00	X	X	X	X	X	.	X	.	.	.	
S045072130	45.00	72.00	13.00	.	.	.	X	.	.	.	.	.	.	
S045074120	45.00	74.00	12.00	.	.	.	X	X	.	.	.	.	.	
S045075060	45.00	75.00	6.00	X	.	.	X	.	.	.	.	.	.	
S045075070	45.00	75.00	7.00	.	.	.	X	.	.	.	.	.	.	
S045075080	45.00	75.00	8.00	X	.	.	X	X	.	.	.	.	.	
S045075100	45.00	75.00	10.00	X	X	X	X	X	.	.	.	.	.	
S045075120	45.00	75.00	12.00	.	.	X	X	X	.	.	.	.	.	
S045075125	45.00	75.00	12.50	.	.	.	.	X	.	.	.	.	.	
S045075130	45.00	75.00	13.00	.	.	X	.	.	.	.	.	.	.	
S045075150	45.00	75.00	15.00	.	.	.	X	.	.	.	.	.	.	
S045078080	45.00	78.00	8.00	.	.	.	X	.	.	.	.	.	.	
S045078120	45.00	78.00	12.00	.	.	.	X	.	.	.	.	.	.	
S045078130	45.00	78.00	13.00	X	.	X	.	.	.	.	.	.	.	
S045080080	45.00	80.00	8.00	X	.	.	.	.	.	.	.	.	.	
S045080100	45.00	80.00	10.00	X	X	X	X	.	.	.	.	.	.	
S045080120	45.00	80.00	12.00	.	.	X	X	.	.	.	.	.	.	
S045080130	45.00	80.00	13.00	X	X	X	X	X	.	.	.	.	.	
S045085080	45.00	85.00	8.00	.	X	.	X	.	.	.	.	.	.	
S045085100	45.00	85.00	10.00	X	X	X	X	.	.	.	.	.	.	
S045085130	45.00	85.00	13.00	X	.	X	.	.	.	.	.	.	.	
S045090100	45.00	90.00	10.00	X	.	X	X	.	.	.	.	.	.	
S045100080	45.00	100.00	8.00	.	.	.	X	.	.	.	.	.	.	
S045100100	45.00	100.00	10.00	X	.	.	X	.	.	.	.	.	.	
S045120120	45.00	120.00	12.00	.	.	.	X	.	.	.	.	.	.	
S046056090	46.00	56.00	9.00	.	X	.	.	.	.	.	.	.	.	









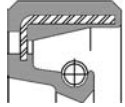

X: EXISTING TOOLING    .: ON REQUEST

N.B.: MINIMUM LINE ORDER MAY APPLY



## RADIAL SHAFT SEALS - NBR/STEEL

METRIC SIZE  
SHAFT SEALS

SC 	Ref. Number	Dimensions			DESIGN TYPE									
		d	D	H	SC	SB2	SA2	TC	TB2	TA2	VB	VC	KB	KC
	S046058050	46.00	58.00	5.00	•	•	•	•	•	•	•	X	•	•
	S046059120	46.00	59.00	12.00	•	•	•	X	•	•	•	•	•	•
	S046060070	46.00	60.00	7.00	•	X	•	X	•	•	•	•	•	•
	S046060080	46.00	60.00	8.00	•	•	•	X	•	•	•	•	•	•
	S046062080	46.00	62.00	8.00	X	•	•	X	•	•	•	•	•	•
	S046062090	46.00	62.00	9.00	X	•	•	•	•	•	•	•	•	•
	S046062120	46.00	62.00	12.00	•	•	X	•	•	•	•	•	•	•
	S046064080	46.00	64.00	8.00	X	•	•	X	•	•	•	•	•	•
	S046064090	46.00	64.00	9.00	•	•	•	X	•	•	•	•	•	•
	S046064140	46.00	64.00	14.00	•	•	•	X	•	•	•	•	•	•
	S046065070	46.00	65.00	7.00	•	•	•	X	•	•	•	•	•	•
	S046065090	46.00	65.00	9.00	•	•	•	X	•	•	•	•	•	•
	S046065100	46.00	65.00	10.00	X	•	X	•	•	•	•	•	•	•
	S046070100	46.00	70.00	10.00	•	•	•	X	•	•	•	•	•	•
	S046070140	46.00	70.00	14.00	•	•	•	X	•	•	•	•	•	•
	S046072100	46.00	72.00	10.00	X	•	X	•	•	•	•	•	•	•
	S046072120	46.00	72.00	12.00	•	•	X	•	•	•	•	•	•	•
	S046073100	46.00	73.00	10.00	•	•	•	X	•	•	•	•	•	•
	S046078100	46.00	78.00	10.00	X	X	•	•	•	•	•	•	•	•
	S046078130	46.00	78.00	13.00	•	•	X	•	•	•	•	•	•	•
	S046080100	46.00	80.00	10.00	•	•	X	•	•	•	•	•	•	•
	S047054035	47.00	54.00	3.50	•	•	•	•	•	•	•	X	•	•
	S047055100	47.00	55.00	10.00	•	•	•	•	•	•	X	•	•	•
	S047058060	47.00	58.00	6.00	X	•	•	•	•	•	•	•	•	•
	S047058070	47.00	58.00	7.00	X	•	•	X	•	•	•	•	•	•
	S047062060	47.00	62.00	6.00	2	•	•	•	•	•	•	•	•	•
	S047062080	47.00	62.00	8.00	X	•	•	•	•	•	•	•	•	•
	S047063120	47.00	63.00	12.00	•	X	•	•	•	•	•	•	•	•
	S047064080	47.00	64.00	8.00	•	•	•	X	•	•	•	•	•	•
	S047065080	47.00	65.00	8.00	X	•	•	•	•	•	•	•	•	•
	S047065090	47.00	65.00	9.00	X	•	•	•	•	•	•	•	•	•
	S047065100	47.00	65.00	10.00	X	•	•	•	•	•	•	•	•	•
	S047065120	47.00	65.00	12.00	•	•	X	•	•	X	•	•	•	•
	S047066060	47.00	66.00	6.00	•	•	•	•	X	•	•	•	•	•
	S047067100	47.00	67.00	10.00	•	•	•	X	•	•	•	•	•	•
	S047067120	47.00	67.00	12.00	X	•	•	•	•	•	•	•	•	•
	S047068060	47.00	68.00	6.00	X	•	•	•	•	•	•	•	•	•
	S047068130	47.00	68.00	13.00	•	•	•	•	X	•	•	•	•	•
	S047070080	47.00	70.00	8.00	•	•	•	X	•	•	•	•	•	•
	S047070100	47.00	70.00	10.00	•	•	•	X	•	•	•	•	•	•
	S047070110	47.00	70.00	11.00	•	•	•	X	•	•	•	•	•	•
	S047070120	47.00	70.00	12.00	•	•	X	X	•	•	•	•	•	•
	S047072080	47.00	72.00	8.00	•	X	•	•	•	•	•	•	•	•
	S047072090	47.00	72.00	9.00	X	•	•	•	•	•	•	•	•	•
	S047072100	47.00	72.00	10.00	X	•	X	•	•	•	•	•	•	•
	S047072120	47.00	72.00	12.00	•	X	•	•	•	•	•	•	•	•
	S047075120	47.00	75.00	12.00	•	•	X	•	•	•	•	•	•	•
	S047080120	47.00	80.00	12.00	•	•	•	X	•	•	•	•	•	•

X: EXISTING TOOLING    •: ON REQUEST

N.B.: MINIMUM LINE ORDER MAY APPLY

Tel.: (888) 238-5885  
Fax: (888) 238-1664

**SS 185**

[www.sealsonline.com](http://www.sealsonline.com)



**M**

## RADIAL SHAFT SEALS - NBR/STEEL

## GLOBAL AVAILABILITY LIST

Ref. Number	Dimensions			DESIGN TYPE										SC 
	d	D	H	SC	SB2	SA2	TC	TB2	TA2	VB	VC	KB	KC	
S048055040	48.00	55.00	4.00	X	•	•	•	•	•	•	•	•	•	
S048058040	48.00	58.00	4.00	X	X	•	•	•	•	•	X	•	•	
S048060070	48.00	60.00	7.00	•	•	•	X	•	•	•	•	•	•	
S048060090	48.00	60.00	9.00	•	•	•	X	•	•	•	•	•	•	
S048060100	48.00	60.00	10.00	•	•	•	X	•	•	•	•	•	•	
S048062050	48.00	62.00	5.00	•	•	•	•	•	•	•	X	•	•	
S048062060	48.00	62.00	6.00	•	•	•	X	•	•	X	•	•	•	
S048062070	48.00	62.00	7.00	X	X	•	X	X	•	•	•	•	•	
S048062080	48.00	62.00	8.00	X	X	•	X	X	•	•	•	•	•	
S048062090	48.00	62.00	9.00	•	X	•	X	X	X	•	•	•	•	
S048062100	48.00	62.00	10.00	X	X	•	X	•	•	•	•	•	•	
S048062110	48.00	62.00	11.00	•	•	•	X	•	•	•	•	•	•	
S048062120	48.00	62.00	12.00	X	•	•	X	X	•	•	•	•	•	
S048062130	48.00	62.00	13.00	•	•	X	•	•	•	•	•	•	•	
S048063110	48.00	63.00	11.00	X	•	•	•	•	•	•	•	•	•	
S048065070	48.00	65.00	7.00	•	•	•	X	•	•	•	•	•	•	
S048065080	48.00	65.00	8.00	X	•	•	X	•	•	•	•	•	•	
S048065090	48.00	65.00	9.00	•	•	•	X	•	•	•	•	•	•	
S048065100	48.00	65.00	10.00	X	X	X	X	X	•	•	•	•	•	
S048065120	48.00	65.00	12.00	X	•	X	X	X	•	•	•	•	•	
S048065140	48.00	65.00	14.00	•	X	•	•	•	•	•	•	•	•	
S048065150	48.00	65.00	15.00	•	•	•	X	•	•	•	•	•	•	
S048066100	48.00	66.00	10.00	•	X	•	•	•	•	•	•	•	•	
S048066120	48.00	66.00	12.00	•	•	•	X	•	•	•	•	•	•	
S048066130	48.00	66.00	13.00	•	•	•	•	X	•	•	•	•	•	
S048067100	48.00	67.00	10.00	•	•	•	X	•	•	•	•	•	•	
S048068080	48.00	68.00	8.00	•	•	•	X	•	•	•	•	•	•	
S048068100	48.00	68.00	10.00	X	X	X	X	•	•	•	•	•	•	
S048068110	48.00	68.00	11.00	•	•	•	X	•	•	•	•	•	•	
S048068120	48.00	68.00	12.00	X	•	X	X	•	•	•	•	•	•	
S048068140	48.00	68.00	14.00	•	•	•	X	•	•	•	•	•	•	
S048069100	48.00	69.00	10.00	•	•	•	X	•	•	•	•	•	•	
S048069120	48.00	69.00	12.00	•	X	•	•	•	•	•	•	•	•	
S048070080	48.00	70.00	8.00	X	•	•	•	•	•	•	•	•	•	
S048070090	48.00	70.00	9.00	X	•	•	X	•	•	•	•	•	•	
S048070095	48.00	70.00	9.50	•	•	•	•	X	•	•	•	•	•	
S048070100	48.00	70.00	10.00	X	•	X	X	•	•	•	•	•	•	
S048070110	48.00	70.00	11.00	•	•	•	X	•	•	•	•	•	•	
S048070120	48.00	70.00	12.00	X	X	X	X	•	•	•	•	•	•	
S048072070	48.00	72.00	7.00	X	•	•	X	X	•	•	•	•	•	
S048072080	48.00	72.00	8.00	X	X	•	X	•	•	•	•	•	•	
S048072090	48.00	72.00	9.00	X	•	•	•	•	•	•	•	•	•	
S048072100	48.00	72.00	10.00	X	X	X	X	•	•	•	•	•	•	
S048072120	48.00	72.00	12.00	X	X	X	X	•	•	•	X	•	•	
S048072150	48.00	72.00	15.00	•	•	•	•	•	•	•	•	•	•	
S048074100	48.00	74.00	10.00	X	•	•	X	•	•	•	•	•	•	
S048074110	48.00	74.00	11.00	•	•	•	•	X	•	•	•	•	•	
S048075080	48.00	75.00	8.00	X	•	•	•	•	•	•	•	•	•	

X: EXISTING TOOLING •: ON REQUEST











N.B.: MINIMUM LINE ORDER MAY APPLY

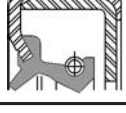

## GLOBAL AVAILABILITY LIST

## RADIAL SHAFT SEALS - NBR/STEEL

METRIC SIZE  
SHAFT SEALS

SC 	Ref. Number	Dimensions			DESIGN TYPE									
		d	D	H	SC	SB2	SA2	TC	TB2	TA2	VB	VC	KB	KC
	S048075120	48.00	75.00	12.00	•	•	•	X	•	•	•	•	•	•
	S048078100	48.00	78.00	10.00	•	•	X	•	•	•	•	•	•	•
	S048079090	48.00	79.00	9.00	•	•	•	X	•	•	•	•	•	•
	S048080080	48.00	80.00	8.00	X	•	•	X	•	•	•	•	•	•
	S048080100	48.00	80.00	10.00	X	•	X	X	•	•	•	•	•	•
	S048080120	48.00	80.00	12.00	•	•	X	X	•	•	•	•	•	•
	S048080130	48.00	80.00	13.00	X	•	X	•	•	•	•	•	•	•
	S048082120	48.00	82.00	12.00	•	•	•	X	X	•	•	•	•	•
	S048082130	48.00	82.00	13.00	•	•	•	•	X	•	•	•	•	•
	S048085060	48.00	85.00	6.00	X	•	•	•	•	•	•	•	•	•
	S048085100	48.00	85.00	10.00	X	•	•	•	•	•	•	•	•	•
	S048085130	48.00	85.00	13.00	X	•	•	•	•	•	•	•	•	•
	S048090100	48.00	90.00	10.00	X	•	•	•	•	•	•	•	•	•
	S048090120	48.00	90.00	12.00	X	•	•	•	•	•	•	•	•	•
	S048090130	48.00	90.00	13.00	•	•	X	X	•	•	•	•	•	•
	S049056090	49.00	56.00	9.00	•	•	•	•	•	•	X	•	•	•
	S049065100	49.00	65.00	10.00	X	•	•	•	•	•	•	•	•	•
	S049068070	49.00	68.00	7.00	X	•	•	•	•	•	•	•	•	•
	S049068090	49.00	68.00	9.00	•	•	•	X	•	•	•	•	•	•
	S049068100	49.00	68.00	10.00	•	•	X	•	•	•	•	•	•	•
	S049068120	49.00	68.00	12.00	X	•	•	•	•	•	•	•	•	•
	S049070095	49.00	70.00	9.50	X	•	•	•	•	•	•	•	•	•
	S049072100	49.00	72.00	10.00	•	•	•	X	•	•	•	•	•	•
	S050054040	50.00	54.00	4.00	•	•	•	•	•	•	X	•	•	•
	S050058040	50.00	58.00	4.00	X	•	•	•	•	•	X	X	•	•
	S050058045	50.00	58.00	4.50	X	•	•	•	•	•	•	•	•	•
	S050058050	50.00	58.00	5.00	•	•	•	•	•	•	X	•	•	•
	S050059040	50.00	59.00	4.00	X	•	•	•	•	•	•	•	•	•
	S050060040	50.00	60.00	4.00	•	•	•	•	•	•	•	X	•	•
	S050060070	50.00	60.00	7.00	X	•	•	•	•	•	•	•	•	•
	S050060075	50.00	60.00	7.50	•	•	•	X	•	•	•	•	•	•
	S050060080	50.00	60.00	8.00	X	•	•	•	•	•	•	•	•	•
	S050060100	50.00	60.00	10.00	X	•	•	•	•	•	•	•	•	•
	S050062050	50.00	62.00	5.00	•	•	•	•	•	•	•	X	•	•
	S050062070	50.00	62.00	7.00	X	X	•	X	•	•	•	•	•	•
	S050062080	50.00	62.00	8.00	X	•	•	X	•	•	•	•	•	•
	S050062100	50.00	62.00	10.00	X	X	X	X	X	•	•	•	•	•
	S050064080	50.00	64.00	8.00	•	•	•	X	•	•	•	•	•	•
	S050064100	50.00	64.00	10.00	X	•	•	X	•	•	•	•	•	•
	S050065060	50.00	65.00	6.00	•	•	•	X	•	•	X	•	•	•
	S050065070	50.00	65.00	7.00	X	•	•	•	•	•	•	•	•	•
	S050065080	50.00	65.00	8.00	X	X	•	X	X	•	•	•	•	•
	S050065090	50.00	65.00	9.00	•	•	•	X	X	•	•	•	•	•
	S050065098	50.00	65.00	9.80	•	•	•	•	X	•	•	•	•	•
	S050065100	50.00	65.00	10.00	X	X	X	X	X	•	•	•	•	•
	S050065120	50.00	65.00	12.00	X	X	X	•	•	•	•	•	•	•
	S050066079	50.00	66.00	7.90	X	•	•	•	•	•	•	•	•	•
	S050066080	50.00	66.00	8.00	X	•	•	•	•	•	•	•	•	•

X: EXISTING TOOLING    •: ON REQUEST

N.B.: MINIMUM LINE ORDER MAY APPLY

Tel.: (204) 783-9617  
Fax: (204) 783-6091

**SS 187**

[www.sealsonline.com](http://www.sealsonline.com)



**M**

## RADIAL SHAFT SEALS - NBR/STEEL

## GLOBAL AVAILABILITY LIST

Ref. Number	Dimensions			DESIGN TYPE										SC 
	d	D	H	SC	SB2	SA2	TC	TB2	TA2	VB	VC	KB	KC	
S050066100	50.00	66.00	10.00	X	X	•	•	•	•	•	•	•	•	
S050067070	50.00	67.00	7.00	•	•	•	X	•	•	•	•	•	•	
S050067090	50.00	67.00	9.00	X	•	•	X	•	•	•	•	•	•	
S050067100	50.00	67.00	10.00	X	•	•	•	•	•	•	•	•	•	
S050067110	50.00	67.00	11.00	•	•	•	X	•	•	•	•	•	•	
S050068070	50.00	68.00	7.00	•	•	•	•	•	•	•	X	•	•	
S050068080	50.00	68.00	8.00	X	X	•	X	•	•	•	•	•	•	
S050068090	50.00	68.00	9.00	X	•	X	X	X	X	•	•	•	•	
S050068100	50.00	68.00	10.00	X	X	X	X	X	•	•	•	•	•	
S050068110	50.00	68.00	11.00	X	•	•	•	•	•	•	•	•	•	
S050068120	50.00	68.00	12.00	X	•	X	•	X	•	•	•	•	•	
S050068140	50.00	68.00	14.00	X	X	•	•	X	•	•	•	•	•	
S050070060	50.00	70.00	6.00	•	•	•	X	•	•	•	•	•	•	
S050070070	50.00	70.00	7.00	•	•	•	•	•	X	•	•	•	•	
S050070080	50.00	70.00	8.00	X	X	X	X	X	X	•	•	•	•	
S050070090	50.00	70.00	9.00	X	X	•	X	X	•	•	•	•	•	
S050070095	50.00	70.00	9.50	•	•	•	X	•	•	•	•	•	•	
S050070100	50.00	70.00	10.00	X	X	X	X	X	•	•	•	•	•	
S050070110	50.00	70.00	11.00	•	•	•	X	•	•	•	•	•	•	
S050070120	50.00	70.00	12.00	X	X	X	X	•	•	•	•	•	•	
S050070135	50.00	70.00	13.50	•	•	•	X	•	•	•	•	•	•	
S050070140	50.00	70.00	14.00	•	X	•	X	•	•	•	•	•	•	
S050072050	50.00	72.00	5.00	•	•	•	•	•	•	•	X	•	•	
S050072060	50.00	72.00	6.00	X	•	•	•	•	•	•	•	•	•	
S050072070	50.00	72.00	7.00	•	•	•	X	•	•	•	•	•	•	
S050072080	50.00	72.00	8.00	X	X	•	X	X	•	•	•	•	•	
S050072090	50.00	72.00	9.00	•	•	•	X	•	•	•	•	•	•	
S050072100	50.00	72.00	10.00	X	X	X	X	X	•	•	•	•	•	
S050072120	50.00	72.00	12.00	X	X	X	X	X	•	•	•	•	•	
S050072130	50.00	72.00	13.00	•	•	•	•	•	•	•	•	•	•	
S050072140	50.00	72.00	14.00	X	•	•	•	•	•	•	•	•	•	
S050073080	50.00	73.00	8.00	•	•	•	X	•	•	•	•	•	•	
S050073090	50.00	73.00	9.00	•	•	•	•	•	X	•	•	•	•	
S050073100	50.00	73.00	10.00	•	•	•	X	•	•	•	•	•	•	
S050074080	50.00	74.00	8.00	•	•	X	•	•	•	•	•	•	•	
S050074090	50.00	74.00	9.00	X	•	•	•	•	•	•	•	•	•	
S050075060	50.00	75.00	6.00	•	•	•	X	•	•	•	X	•	•	
S050075090	50.00	75.00	9.00	•	X	•	•	•	•	•	•	•	•	
S050075100	50.00	75.00	10.00	X	X	X	X	•	•	•	•	•	•	
S050075120	50.00	75.00	12.00	X	•	X	X	•	•	•	•	•	•	
S050075130	50.00	75.00	13.00	X	•	•	•	•	•	•	•	•	•	
S050076100	50.00	76.00	10.00	X	•	•	•	•	•	•	•	•	•	
S050076120	50.00	76.00	12.00	•	•	•	X	•	•	•	•	•	•	
S050076130	50.00	76.00	13.00	•	•	•	•	X	•	•	•	•	•	
S050078100	50.00	78.00	10.00	X	•	•	•	•	•	•	•	•	•	
S050078120	50.00	78.00	12.00	X	•	•	X	•	•	•	•	•	•	
S050078130	50.00	78.00	13.00	•	•	X	•	•	•	•	•	•	•	
S050080080	50.00	80.00	8.00	X	X	•	X	•	•	•	•	•	•	

X: EXISTING TOOLING •: ON REQUEST

N.B.: MINIMUM LINE ORDER MAY APPLY



## GLOBAL AVAILABILITY LIST

## RADIAL SHAFT SEALS - NBR/STEEL

**METRIC SIZE  
SHAFT SEALS**

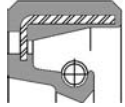
SC 	Ref. Number	Dimensions			DESIGN TYPE									
		d	D	H	SC	SB2	SA2	TC	TB2	TA2	VB	VC	KB	KC
	S050080100	50.00	80.00	10.00	X	X	X	X	•	X	•	•	•	•
	S050080120	50.00	80.00	12.00	X	X	X	X	•	•	•	•	•	•
	S050080130	50.00	80.00	13.00	X	X	X	X	•	X	•	•	•	•
	S050080140	50.00	80.00	14.00	X	•	•	•	•	•	•	•	•	•
	S050082120	50.00	82.00	12.00	•	•	•	X	•	•	•	•	•	•
	S050085060	50.00	85.00	6.00	X	•	•	•	•	•	•	•	•	•
	S050085080	50.00	85.00	8.00	X	•	•	X	•	•	•	•	•	•
	S050085100	50.00	85.00	10.00	X	X	X	X	•	•	•	•	•	•
	S050085120	50.00	85.00	12.00	X	X	•	X	•	•	•	•	•	•
	S050085130	50.00	85.00	13.00	X	•	X	•	•	•	•	•	•	•
	S050090060	50.00	90.00	6.00	•	•	•	•	•	•	X	•	•	•
	S050090080	50.00	90.00	8.00	•	•	•	X	•	•	•	•	•	•
	S050090100	50.00	90.00	10.00	X	X	X	X	•	•	•	•	•	•
	S050090120	50.00	90.00	12.00	•	•	X	X	•	•	•	•	•	•
	S050090130	50.00	90.00	13.00	X	X	X	•	•	•	•	•	•	•
	S050095070	50.00	95.00	7.00	X	•	•	•	•	•	•	•	•	•
	S050095100	50.00	95.00	10.00	•	•	X	•	•	•	•	•	•	•
	S050110100	50.00	110.00	10.00	•	•	•	X	•	•	•	•	•	•
	S050110105	50.00	110.00	10.50	X	•	•	•	•	•	•	•	•	•
	S050110120	50.00	110.00	12.00	X	•	•	•	•	•	•	•	•	•
	S051058040	51.00	58.00	4.00	•	•	•	•	•	•	X	•	•	•
	S051064070	51.00	64.00	7.00	•	•	•	X	•	•	•	•	•	•
	S051065070	51.00	65.00	7.00	•	•	•	•	X	•	•	•	•	•
	S051065090	51.00	65.00	9.00	•	•	•	•	X	•	•	•	•	•
	S051065130	51.00	65.00	13.00	•	•	•	X	•	•	•	•	•	•
	S051070100	51.00	70.00	10.00	•	•	•	X	•	•	•	•	•	•
	S051072100	51.00	72.00	10.00	X	•	•	•	•	•	•	•	•	•
	S052060080	52.00	60.00	8.00	X	•	•	•	•	•	•	•	•	•
	S052062080	52.00	62.00	8.00	X	•	•	•	•	•	•	•	•	•
	S052063080	52.00	63.00	8.00	•	•	•	X	•	•	•	•	•	•
	S052065060	52.00	65.00	6.00	•	•	•	•	•	•	•	X	•	•
	S052065080	52.00	65.00	8.00	X	•	•	•	•	•	•	•	•	•
	S052065090	52.00	65.00	9.00	X	•	•	X	X	•	•	•	•	•
	S052065100	52.00	65.00	10.00	•	•	•	X	•	•	•	•	•	•
	S052068070	52.00	68.00	7.00	X	X	•	•	•	•	•	•	•	•
	S052068080	52.00	68.00	8.00	X	X	X	X	X	•	•	•	•	•
	S052068090	52.00	68.00	9.00	X	•	•	•	•	•	•	•	•	•
	S052068100	52.00	68.00	10.00	X	•	X	X	X	•	•	•	•	•
	S052068120	52.00	68.00	12.00	•	•	X	•	•	•	•	•	•	•
	S052068130	52.00	68.00	13.00	X	X	•	X	•	•	•	•	•	•
	S052068135	52.00	68.00	13.50	•	•	•	•	X	•	•	•	•	•
	S052069100	52.00	69.00	10.00	X	•	•	X	•	•	•	•	•	•
	S052069110	52.00	69.00	11.00	•	•	•	•	•	•	X	•	•	•
	S052069120	52.00	69.00	12.00	•	•	X	•	•	•	•	•	•	•
	S052070070	52.00	70.00	7.00	•	•	•	X	•	•	•	•	•	•
	S052070080	52.00	70.00	8.00	•	•	•	X	•	•	•	•	•	•
	S052070090	52.00	70.00	9.00	•	X	•	X	X	•	•	•	•	•
	S052070100	52.00	70.00	10.00	X	•	X	•	•	•	•	•	•	•

X: EXISTING TOOLING    •: ON REQUEST

N.B.: MINIMUM LINE ORDER MAY APPLY

**Tel.: (780) 414-1871**  
**Fax: (780) 487-5419**

**SS 189**

[www.sealsonline.com](http://www.sealsonline.com)



**M**

## RADIAL SHAFT SEALS - NBR/STEEL

## GLOBAL AVAILABILITY LIST

Ref. Number	Dimensions			DESIGN TYPE										SC 
	d	D	H	SC	SB2	SA2	TC	TB2	TA2	VB	VC	KB	KC	
S052072080	52.00	72.00	8.00	X	X	•	X	•	•	•	•	•	•	
S052072090	52.00	72.00	9.00	•	•	•	X	•	•	•	•	•	•	
S052072100	52.00	72.00	10.00	X	X	X	X	•	•	•	•	•	•	
S052072120	52.00	72.00	12.00	X	X	X	X	X	•	•	•	•	•	
S052075090	52.00	75.00	9.00	•	•	•	X	•	•	•	•	•	•	
S052075100	52.00	75.00	10.00	X	X	X	X	•	•	•	•	•	•	
S052075120	52.00	75.00	12.00	X	•	X	X	•	•	•	•	•	•	
S052075150	52.00	75.00	15.00	•	•	•	X	•	•	•	•	•	•	
S052076130	52.00	76.00	13.00	X	•	•	•	•	•	•	•	•	•	
S052078120	52.00	78.00	12.00	•	•	•	X	•	•	•	•	•	•	
S052078130	52.00	78.00	13.00	X	•	X	•	•	•	•	•	•	•	
S052080080	52.00	80.00	8.00	X	•	•	X	•	•	•	•	•	•	
S052080100	52.00	80.00	10.00	X	X	X	•	•	•	•	•	•	•	
S052080120	52.00	80.00	12.00	•	•	X	•	•	•	•	•	•	•	
S052080130	52.00	80.00	13.00	X	•	X	•	X	•	•	•	•	•	
S052085080	52.00	85.00	8.00	X	•	•	•	•	•	•	•	•	•	
S052085100	52.00	85.00	10.00	X	X	X	X	•	•	•	•	•	•	
S052085120	52.00	85.00	12.00	•	•	X	•	•	•	•	•	•	•	
S052085130	52.00	85.00	13.00	•	•	X	•	•	•	•	•	•	•	
S052090130	52.00	90.00	13.00	•	•	X	•	•	•	•	•	•	•	
S053065100	53.00	65.00	10.00	X	•	•	X	•	•	•	•	•	•	
S053066064	53.00	66.00	6.40	•	•	•	X	•	•	•	•	•	•	
S053068100	53.00	68.00	10.00	X	X	X	•	•	•	•	•	•	•	
S053068130	53.00	68.00	13.00	X	•	•	•	•	•	•	•	•	•	
S053070060	53.00	70.00	6.00	•	•	•	•	•	•	•	X	•	•	
S053072100	53.00	72.00	10.00	•	•	•	X	•	•	•	•	•	•	
S053072120	53.00	72.00	12.00	X	•	•	•	•	•	•	•	•	•	
S053079100	53.00	79.00	10.00	X	•	•	•	•	•	•	•	•	•	
S053080100	53.00	80.00	10.00	X	•	•	•	•	•	•	•	•	•	
S053080130	53.00	80.00	13.00	•	•	X	•	•	•	•	•	•	•	
S054065130	54.00	65.00	13.00	•	•	•	X	X	•	•	•	•	•	
S054066070	54.00	66.00	7.00	•	•	•	X	•	•	•	•	•	•	
S054068100	54.00	68.00	10.00	•	•	•	X	•	•	•	•	•	•	
S054068105	54.00	68.00	10.50	X	•	•	•	•	•	•	•	•	•	
S054068120	54.00	68.00	12.00	•	•	•	X	•	•	•	•	•	•	
S054070090	54.00	70.00	9.00	•	•	•	X	•	•	•	•	•	•	
S054070100	54.00	70.00	10.00	X	X	•	X	•	•	•	•	•	•	
S054070120	54.00	70.00	12.00	•	•	X	•	•	•	•	•	•	•	
S054072050	54.00	72.00	5.00	X	•	•	•	•	•	•	•	•	•	
S054072080	54.00	72.00	8.00	X	•	•	X	•	•	•	•	•	•	
S054072090	54.00	72.00	9.00	•	•	•	X	•	•	•	•	•	•	
S054072100	54.00	72.00	10.00	X	X	X	X	•	•	•	•	•	•	
S054072120	54.00	72.00	12.00	•	X	X	•	•	•	•	•	•	•	
S054074080	54.00	74.00	8.00	X	X	•	•	X	•	•	•	•	•	
S054074100	54.00	74.00	10.00	•	•	•	X	•	•	•	•	•	•	
S054075120	54.00	75.00	12.00	X	•	•	•	•	•	•	•	•	•	
S054076080	54.00	76.00	8.00	•	•	•	X	•	•	•	•	•	•	
S054076120	54.00	76.00	12.00	X	•	•	•	•	•	•	•	•	•	

X: EXISTING TOOLING •: ON REQUEST











N.B.: MINIMUM LINE ORDER MAY APPLY

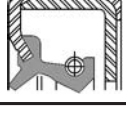

## GLOBAL AVAILABILITY LIST

## RADIAL SHAFT SEALS - NBR/STEEL

METRIC SIZE  
SHAFT SEALS

SC 	Ref. Number	Dimensions			DESIGN TYPE									
		d	D	H	SC	SB2	SA2	TC	TB2	TA2	VB	VC	KB	KC
	S054076125	54.00	76.00	12.50	X	.	.	.	.	.	.	.	.	.
	S054076130	54.00	76.00	13.00	.	.	.	X	.	.	.	.	.	.
	S054078120	54.00	78.00	12.00	X	.	.	.	.	.	.	.	.	.
	S054080080	54.00	80.00	8.00	X	.	.	.	.	.	.	.	.	.
	S054080100	54.00	80.00	10.00	.	X	X	.	.	.	.	.	.	.
	S054080120	54.00	80.00	12.00	.	X	X	.	.	.	.	.	.	.
	S054080130	54.00	80.00	13.00	.	X	X	X	.	.	.	.	.	.
	S054081100	54.00	81.00	10.00	.	.	.	X	.	.	.	.	.	.
	S054082100	54.00	82.00	10.00	.	.	.	X	.	.	.	.	.	.
	S054082110	54.00	82.00	11.00	X	.	.	.	.	.	.	.	.	.
	S054082115	54.00	82.00	11.50	.	.	.	X	.	.	.	.	.	.
	S054085100	54.00	85.00	10.00	.	.	X	X	.	.	.	.	.	.
	S054085150	54.00	85.00	15.00	X	.	.	.	.	.	.	.	.	.
	S054090130	54.00	90.00	13.00	X	.	X	.	.	.	.	.	.	.
	S055063050	55.00	63.00	5.00	.	.	.	.	.	.	X	X	.	.
	S055065050	55.00	65.00	5.00	.	.	.	.	.	.	X	.	.	.
	S055065080	55.00	65.00	8.00	X	.	.	.	.	.	.	.	.	.
	S055066080	55.00	66.00	8.00	X	.	.	.	.	.	.	.	.	.
	S055067050	55.00	67.00	5.00	.	.	.	.	.	.	X	.	.	.
	S055067120	55.00	67.00	12.00	.	.	.	X	.	.	.	.	.	.
	S055068080	55.00	68.00	8.00	X	X	.	X	.	.	.	.	.	.
	S055070060	55.00	70.00	6.00	.	.	.	X	.	.	.	X	.	.
	S055070070	55.00	70.00	7.00	X	.	.	.	.	.	.	.	.	.
	S055070080	55.00	70.00	8.00	X	X	.	X	X	.	.	.	.	.
	S055070090	55.00	70.00	9.00	X	.	X	X	.	.	X	.	.	.
	S055070100	55.00	70.00	10.00	X	X	X	X	.	.	.	.	.	.
	S055070120	55.00	70.00	12.00	.	.	X	.	.	.	.	.	.	.
	S055072070	55.00	72.00	7.00	X	.	.	X	.	.	.	X	.	.
	S055072080	55.00	72.00	8.00	X	X	.	X	.	.	.	.	.	.
	S055072090	55.00	72.00	9.00	.	.	.	X	X	.	.	.	.	.
	S055072100	55.00	72.00	10.00	X	X	X	X	X	.	.	.	.	.
	S055072120	55.00	72.00	12.00	X	X	X	X	X	X	.	.	.	.
	S055072130	55.00	72.00	13.00	X	.	.	.	.	.	.	.	.	.
	S055073100	55.00	73.00	10.00	.	.	.	.	X	.	.	.	.	.
	S055074060	55.00	74.00	6.00	.	.	.	.	.	.	X	.	.	.
	S055074100	55.00	74.00	10.00	.	.	.	X	.	.	.	.	.	.
	S055075080	55.00	75.00	8.00	X	.	.	X	.	.	.	.	.	.
	S055075090	55.00	75.00	9.00	.	.	.	X	X	.	.	.	.	.
	S055075100	55.00	75.00	10.00	X	X	X	X	X	.	.	.	.	.
	S055075120	55.00	75.00	12.00	X	X	X	X	X	.	.	X	.	.
	S055075150	55.00	75.00	15.00	.	.	.	.	.	.	.	.	.	.
	S055076080	55.00	76.00	8.00	.	.	.	X	.	.	.	.	.	.
	S055076120	55.00	76.00	12.00	.	.	.	X	.	.	.	.	.	.
	S055077100	55.00	77.00	10.00	.	.	.	X	.	.	.	.	.	.
	S055078080	55.00	78.00	8.00	X	.	.	X	.	.	.	.	.	.
	S055078090	55.00	78.00	9.00	X	.	.	X	.	.	.	.	.	.
	S055078100	55.00	78.00	10.00	X	.	.	X	.	.	.	.	.	.
	S055078120	55.00	78.00	12.00	X	.	X	X	X	.	.	.	.	.

X: EXISTING TOOLING    .: ON REQUEST

N.B.: MINIMUM LINE ORDER MAY APPLY

Tel.: (604) 278-6808  
Fax: (604) 278-6180

**SS 191**

[www.sealsonline.com](http://www.sealsonline.com)



**M**



## RADIAL SHAFT SEALS - NBR/STEEL

## GLOBAL AVAILABILITY LIST

Ref. Number	Dimensions			DESIGN TYPE									SC
	d	D	H	SC	SB2	SA2	TC	TB2	TA2	VB	VC	KB	
S055078130	55.00	78.00	13.00	•	•	X	•	•	•	•	•	•	•
S055080050	55.00	80.00	5.00	X	•	•	•	•	•	•	•	•	•
S055080060	55.00	80.00	6.00	X	•	•	•	•	•	•	•	•	•
S055080080	55.00	80.00	8.00	X	X	X	X	X	•	•	•	•	•
S055080100	55.00	80.00	10.00	X	X	X	X	X	X	•	•	•	•
S055080120	55.00	80.00	12.00	X	X	X	X	X	•	•	•	•	•
S055080130	55.00	80.00	13.00	X	X	X	X	X	X	•	•	•	•
S055082094	55.00	82.00	9.40	•	•	•	X	•	•	•	•	•	•
S055082100	55.00	82.00	10.00	•	•	•	X	X	•	X	•	•	•
S055082120	55.00	82.00	12.00	•	•	•	X	•	•	•	•	•	•
S055084140	55.00	84.00	14.00	•	•	•	X	•	•	•	•	•	•
S055085080	55.00	85.00	8.00	X	X	•	X	•	•	•	•	•	•
S055085100	55.00	85.00	10.00	X	•	X	X	•	•	•	•	•	•
S055085120	55.00	85.00	12.00	•	•	X	X	•	•	•	•	•	•
S055085130	55.00	85.00	13.00	X	X	X	•	X	•	•	•	•	•
S055085140	55.00	85.00	14.00	•	•	•	•	X	•	•	•	•	•
S055085160	55.00	85.00	16.00	X	•	•	•	•	•	•	•	•	•
S055088100	55.00	88.00	10.00	X	•	•	X	•	•	•	•	•	•
S055088120	55.00	88.00	12.00	•	•	•	X	•	•	•	•	•	•
S055090060	55.00	90.00	6.00	•	•	•	•	•	•	X	•	•	•
S055090080	55.00	90.00	8.00	X	•	•	X	•	•	•	•	•	•
S055090100	55.00	90.00	10.00	X	•	•	X	•	•	•	•	•	•
S055090120	55.00	90.00	12.00	X	•	•	X	•	•	•	•	•	•
S055090130	55.00	90.00	13.00	X	X	X	•	•	•	•	•	•	•
S055100100	55.00	100.00	10.00	X	•	•	X	•	•	•	•	•	•
S055100120	55.00	100.00	12.00	X	•	•	X	•	•	•	•	•	•
S055100130	55.00	100.00	13.00	X	•	X	•	•	•	•	•	•	•
S055100160	55.00	100.00	16.00	X	•	•	•	•	•	•	•	•	•
S056065120	56.00	65.00	12.00	•	•	•	X	•	•	•	•	•	•
S056068110	56.00	68.00	11.00	•	X	•	•	•	•	•	•	•	•
S056069100	56.00	69.00	10.00	X	•	•	•	•	•	•	•	•	•
S056070080	56.00	70.00	8.00	X	•	•	X	•	•	•	•	•	•
S056070090	56.00	70.00	9.00	•	•	•	X	•	•	•	•	•	•
S056070096	56.00	70.00	9.60	•	•	•	X	•	•	•	•	•	•
S056070120	56.00	70.00	12.00	•	•	•	•	X	•	•	•	•	•
S056072070	56.00	72.00	7.00	•	•	•	X	•	•	•	•	•	•
S056072080	56.00	72.00	8.00	X	X	•	•	X	•	•	•	•	•
S056072090	56.00	72.00	9.00	X	•	•	X	•	•	•	•	•	•
S056072100	56.00	72.00	10.00	X	•	X	•	X	•	•	•	•	•
S056072125	56.00	72.00	12.50	•	•	•	X	•	•	•	•	•	•
S056074080	56.00	74.00	8.00	X	•	•	•	•	•	•	•	•	•
S056074100	56.00	74.00	10.00	•	•	•	X	•	•	•	•	•	•
S056076110	56.00	76.00	11.00	X	•	•	•	•	•	•	•	•	•
S056078120	56.00	78.00	12.00	•	•	•	X	•	•	•	•	•	•
S056080080	56.00	80.00	8.00	X	•	•	X	•	•	•	•	•	•
S056080100	56.00	80.00	10.00	•	X	X	•	•	•	•	•	•	•
S056080120	56.00	80.00	12.00	•	•	•	X	•	•	•	•	•	•
S056080130	56.00	80.00	13.00	•	•	X	•	•	•	•	•	•	•

X: EXISTING TOOLING •: ON REQUEST



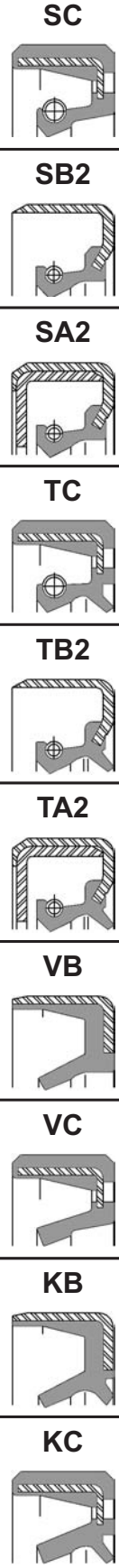





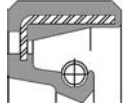

N.B.: MINIMUM LINE ORDER MAY APPLY



## GLOBAL AVAILABILITY LIST

## RADIAL SHAFT SEALS - NBR/STEEL

METRIC SIZE  
SHAFT SEALS

SC 	Ref. Number	Dimensions			DESIGN TYPE									
		d	D	H	SC	SB2	SA2	TC	TB2	TA2	VB	VC	KB	KC
	S056085070	56.00	85.00	7.00	X	•	•	•	•	•	•	•	•	•
	S056085080	56.00	85.00	8.00	X	•	•	X	•	•	•	•	•	•
	S056085100	56.00	85.00	10.00	X	•	X	•	•	•	•	•	•	•
	S056085130	56.00	85.00	13.00	X	•	•	X	•	•	•	•	•	•
	S056086130	56.00	86.00	13.00	•	•	•	X	•	•	•	•	•	•
	S056088100	56.00	88.00	10.00	X	•	•	•	•	•	•	•	•	•
	S056088130	56.00	88.00	13.00	X	•	•	•	•	•	•	•	•	•
	S056090100	56.00	90.00	10.00	X	•	•	•	•	•	•	•	•	•
	S056090130	56.00	90.00	13.00	•	X	X	X	•	•	•	•	•	•
	S056100100	56.00	100.00	10.00	X	•	•	X	•	•	•	•	•	•
	S056100120	56.00	100.00	12.00	•	•	•	X	•	•	•	•	•	•
	S057067070	57.00	67.00	7.00	•	•	•	X	•	•	•	•	•	•
	S057072090	57.00	72.00	9.00	•	•	•	•	X	•	•	•	•	•
	S057072100	57.00	72.00	10.00	X	•	X	•	•	•	•	•	•	•
	S057072120	57.00	72.00	12.00	•	•	•	•	X	•	•	•	•	•
	S057073070	57.00	73.00	7.00	•	•	•	X	•	•	•	•	•	•
	S057075075	57.00	75.00	7.50	•	•	•	X	•	•	•	•	•	•
	S057075090	57.00	75.00	9.00	•	X	•	•	•	•	•	•	•	•
	S057075100	57.00	75.00	10.00	X	•	•	•	•	•	•	•	•	•
	S057075120	57.00	75.00	12.00	X	•	•	•	•	•	•	•	•	•
	S057076125	57.00	76.00	12.50	X	•	•	•	•	•	•	•	•	•
	S057078120	57.00	78.00	12.00	X	•	•	•	•	•	•	•	•	•
	S057080120	57.00	80.00	12.00	•	•	X	X	•	•	•	•	•	•
	S057080130	57.00	80.00	13.00	X	•	•	•	•	•	•	•	•	•
	S057085100	57.00	85.00	10.00	X	•	X	•	•	•	•	•	•	•
	S057085120	57.00	85.00	12.00	•	•	X	X	•	•	•	•	•	•
	S057085130	57.00	85.00	13.00	X	•	X	X	•	•	•	•	•	•
	S057086130	57.00	86.00	13.00	•	•	•	X	•	•	•	•	•	•
	S057087150	57.00	87.00	15.00	X	•	•	•	•	•	•	•	•	•
	S057088135	57.00	88.00	13.50	•	•	•	X	•	•	•	•	•	•
	S057089135	57.00	89.00	13.50	•	•	•	X	•	•	•	•	•	•
	S057090130	57.00	90.00	13.00	X	X	X	•	•	•	•	•	•	•
	S057095100	57.00	95.00	10.00	X	•	•	•	•	•	•	•	•	•
	S058068090	58.00	68.00	9.00	•	•	•	X	•	•	•	•	•	•
	S058070060	58.00	70.00	6.00	X	•	•	•	•	•	•	•	•	•
	S058070080	58.00	70.00	8.00	•	X	•	•	•	•	•	•	•	•
	S058072070	58.00	72.00	7.00	X	•	•	•	•	•	•	•	•	•
	S058072080	58.00	72.00	8.00	X	X	X	X	X	•	•	•	•	•
	S058072090	58.00	72.00	9.00	X	•	•	X	•	•	•	•	•	•
	S058072120	58.00	72.00	12.00	•	•	•	X	•	•	•	•	•	•
	S058074100	58.00	74.00	10.00	•	•	•	X	•	•	•	•	•	•
	S058075050	58.00	75.00	5.00	X	•	•	•	•	•	•	•	•	•
	S058075080	58.00	75.00	8.00	•	X	•	•	•	•	•	•	•	•
	S058075090	58.00	75.00	9.00	X	•	•	X	•	•	•	•	•	•
	S058075100	58.00	75.00	10.00	X	X	•	•	•	•	•	•	•	•
	S058075120	58.00	75.00	12.00	X	•	X	X	•	•	•	•	•	•
	S058075130	58.00	75.00	13.00	•	•	•	X	•	•	•	•	•	•
	S058076090	58.00	76.00	9.00	X	•	•	•	•	•	•	•	•	•

X: EXISTING TOOLING    •: ON REQUEST

N.B.: MINIMUM LINE ORDER MAY APPLY

Tel.: (418) 688-3202  
Fax: (418) 688-4272

**SS 193**

[www.sealsonline.com](http://www.sealsonline.com)



**M**

## RADIAL SHAFT SEALS - NBR/STEEL

## GLOBAL AVAILABILITY LIST

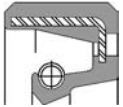
Ref. Number	Dimensions			DESIGN TYPE										SC 
	d	D	H	SC	SB2	SA2	TC	TB2	TA2	VB	VC	KB	KC	
S058076130	58.00	76.00	13.00	•	•	•	X	•	•	•	•	•	•	
S058078100	58.00	78.00	10.00	X	•	•	•	•	•	•	•	•	•	
S058078130	58.00	78.00	13.00	X	•	X	•	•	•	•	•	•	•	
S058080080	58.00	80.00	8.00	X	•	•	X	X	•	•	•	•	•	
S058080090	58.00	80.00	9.00	•	•	•	X	•	•	•	•	•	•	
S058080100	58.00	80.00	10.00	X	X	X	X	•	•	•	•	•	•	
S058080120	58.00	80.00	12.00	X	•	X	X	•	•	•	•	•	•	
S058080130	58.00	80.00	13.00	X	X	X	X	•	•	•	•	•	•	
S058082120	58.00	82.00	12.00	•	•	•	X	•	•	•	•	•	•	
S058085100	58.00	85.00	10.00	X	X	X	X	•	•	•	•	•	•	
S058085120	58.00	85.00	12.00	X	•	X	•	•	•	•	•	•	•	
S058085130	58.00	85.00	13.00	X	•	X	•	•	•	•	•	•	•	
S058086140	58.00	86.00	14.00	X	•	•	•	•	•	•	•	•	•	
S058090080	58.00	90.00	8.00	•	•	•	X	•	•	•	•	•	•	
S058090100	58.00	90.00	10.00	X	•	•	X	•	•	•	•	•	•	
S058090110	58.00	90.00	11.00	X	•	•	X	•	•	•	•	•	•	
S058090130	58.00	90.00	13.00	X	X	X	•	•	•	•	•	•	•	
S058102120	58.00	102.00	12.00	•	•	•	•	X	•	•	•	•	•	
S059080100	59.00	80.00	10.00	X	•	•	•	•	•	•	•	•	•	
S059085080	59.00	85.00	8.00	X	•	•	•	•	•	•	•	•	•	
S059085190	59.00	85.00	19.00	•	•	•	•	X	•	•	•	•	•	
S060067040	60.00	67.00	4.00	•	•	•	•	•	•	X	•	•	•	
S060070070	60.00	70.00	7.00	X	X	•	•	•	•	•	•	•	•	
S060070100	60.00	70.00	10.00	•	•	•	•	•	•	•	X	•	•	
S060070135	60.00	70.00	13.50	•	•	•	•	•	•	•	X	•	•	
S060072040	60.00	72.00	4.00	•	•	•	•	•	•	•	X	•	•	
S060072070	60.00	72.00	7.00	•	X	•	•	•	•	•	•	•	•	
S060072075	60.00	72.00	7.50	•	X	•	•	•	•	•	•	•	•	
S060072080	60.00	72.00	8.00	X	X	•	X	•	•	•	•	•	•	
S060072085	60.00	72.00	8.50	X	•	•	•	•	•	•	•	•	•	
S060072120	60.00	72.00	12.00	•	•	•	X	•	•	•	•	•	•	
S060074075	60.00	74.00	7.50	•	X	•	•	•	•	•	•	•	•	
S060074080	60.00	74.00	8.00	•	X	•	•	•	•	•	•	•	•	
S060074100	60.00	74.00	10.00	X	•	•	•	•	•	•	•	•	•	
S060075050	60.00	75.00	5.00	•	•	•	•	•	•	X	•	•	•	
S060075060	60.00	75.00	6.00	•	•	•	•	•	•	X	•	•	•	
S060075070	60.00	75.00	7.00	X	X	•	•	•	•	•	•	•	•	
S060075080	60.00	75.00	8.00	X	X	X	X	X	•	•	•	•	•	
S060075090	60.00	75.00	9.00	X	•	•	X	•	•	•	•	•	•	
S060075100	60.00	75.00	10.00	X	•	•	X	•	•	X	•	•	•	
S060075120	60.00	75.00	12.00	X	•	X	X	•	•	•	•	•	•	
S060076100	60.00	76.00	10.00	X	•	•	•	•	•	•	•	•	•	
S060077120	60.00	77.00	12.00	•	•	•	X	X	•	•	•	•	•	
S060078070	60.00	78.00	7.00	X	•	•	•	•	•	X	•	•	•	
S060078090	60.00	78.00	9.00	X	•	•	X	•	•	•	•	•	•	
S060078100	60.00	78.00	10.00	X	•	•	X	•	•	X	•	•	•	
S060078120	60.00	78.00	12.00	•	•	•	X	•	•	•	•	•	•	
S060078130	60.00	78.00	13.00	X	•	X	•	•	•	•	•	•	•	

X: EXISTING TOOLING •: ON REQUEST











N.B.: MINIMUM LINE ORDER MAY APPLY

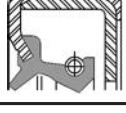

## GLOBAL AVAILABILITY LIST

## RADIAL SHAFT SEALS - NBR/STEEL

METRIC SIZE  
SHAFT SEALS

SC 	Ref. Number	Dimensions			DESIGN TYPE									
		d	D	H	SC	SB2	SA2	TC	TB2	TA2	VB	VC	KB	KC
	S060080040	60.00	80.00	4.00	•	•	•	•	•	•	•	X	•	•
	S060080070	60.00	80.00	7.00	X	•	•	X	•	•	•	•	•	•
	S060080080	60.00	80.00	8.00	X	X	X	X	X	X	•	•	•	•
	S060080090	60.00	80.00	9.00	X	•	•	X	•	•	•	•	•	•
	S060080100	60.00	80.00	10.00	X	X	X	X	X	•	•	•	•	•
	S060080120	60.00	80.00	12.00	X	X	X	X	X	X	•	•	•	•
	S060080130	60.00	80.00	13.00	X	X	X	X	X	X	•	•	•	•
	S060082070	60.00	82.00	7.00	•	•	•	X	•	•	•	•	•	•
	S060082090	60.00	82.00	9.00	X	•	•	X	•	•	•	•	•	•
	S060082100	60.00	82.00	10.00	•	•	•	X	X	•	•	•	•	•
	S060082120	60.00	82.00	12.00	X	X	•	X	•	X	•	•	•	•
	S060082130	60.00	82.00	13.00	•	•	•	•	X	•	•	•	•	•
	S060085080	60.00	85.00	8.00	X	X	X	X	X	•	•	•	•	•
	S060085100	60.00	85.00	10.00	X	•	X	X	•	•	•	•	•	•
	S060085120	60.00	85.00	12.00	X	•	X	X	•	•	•	•	•	•
	S060085130	60.00	85.00	13.00	X	X	X	X	X	X	•	•	•	•
	S060085180	60.00	85.00	18.00	•	•	•	•	X	•	•	•	•	•
	S060088120	60.00	88.00	12.00	•	•	•	X	•	•	•	•	•	•
	S060088140	60.00	88.00	14.00	•	•	•	X	•	•	•	•	•	•
	S060089110	60.00	89.00	11.00	X	•	•	•	•	•	•	•	•	•
	S060090080	60.00	90.00	8.00	X	X	•	X	•	•	•	•	•	•
	S060090100	60.00	90.00	10.00	X	X	X	X	X	•	•	•	•	•
	S060090110	60.00	90.00	11.00	•	•	•	X	•	•	•	•	•	•
	S060090120	60.00	90.00	12.00	•	X	X	•	•	•	•	•	•	•
	S060090130	60.00	90.00	13.00	X	X	X	X	X	•	•	•	•	•
	S060090160	60.00	90.00	16.00	•	•	•	X	•	•	•	•	•	•
	S060091160	60.00	91.00	16.00	•	•	•	X	•	•	•	•	•	•
	S060092110	60.00	92.00	11.00	X	•	•	•	•	•	•	•	•	•
	S060093130	60.00	93.00	13.00	X	•	•	•	•	•	•	•	•	•
	S060095080	60.00	95.00	8.00	X	•	•	X	•	•	•	•	•	•
	S060095100	60.00	95.00	10.00	X	•	X	X	•	•	•	•	•	•
	S060095120	60.00	95.00	12.00	•	•	•	X	•	•	•	•	•	•
	S060095130	60.00	95.00	13.00	•	•	X	X	•	•	•	•	•	•
	S060100100	60.00	100.00	10.00	X	•	•	•	•	•	•	•	•	•
	S060100120	60.00	100.00	12.00	•	•	X	•	•	•	•	•	•	•
	S060100130	60.00	100.00	13.00	X	•	X	•	•	•	•	•	•	•
	S060104120	60.00	104.00	12.00	•	•	•	X	•	•	•	•	•	•
	S060110040	60.00	110.00	4.00	•	•	•	•	•	•	•	X	•	•
	S060110100	60.00	110.00	10.00	•	•	•	X	•	•	•	•	•	•
	S060110120	60.00	110.00	12.00	X	•	•	•	•	•	•	•	•	•
	S060110130	60.00	110.00	13.00	X	•	X	•	•	•	•	•	•	•
	S060130150	60.00	130.00	15.00	X	•	•	•	•	•	•	•	•	•
	S061075080	61.00	75.00	8.00	•	X	•	•	•	•	•	•	•	•
	S061080130	61.00	80.00	13.00	X	•	•	•	•	•	•	•	•	•
	S061085100	61.00	85.00	10.00	•	•	•	X	•	•	•	•	•	•
	S061085130	61.00	85.00	13.00	•	•	X	•	X	•	•	•	•	•
	S062070100	62.00	70.00	10.00	•	•	•	•	•	•	•	X	•	•
	S062072090	62.00	72.00	9.00	•	•	•	X	•	•	•	•	•	•

X: EXISTING TOOLING    •: ON REQUEST

N.B.: MINIMUM LINE ORDER MAY APPLY

Tel.: (514) 334-2220  
Fax: (514) 333-8329

**SS 195**

[www.sealsonline.com](http://www.sealsonline.com)



**M**

## RADIAL SHAFT SEALS - NBR/STEEL

## GLOBAL AVAILABILITY LIST

Ref. Number	Dimensions			DESIGN TYPE									SC
	d	D	H	SC	SB2	SA2	TC	TB2	TA2	VB	VC	KB	
S062072100	62.00	72.00	10.00	•	•	•	X	•	•	•	•	•	•
S062075100	62.00	75.00	10.00	X	X	X	•	•	•	•	•	•	•
S062075130	62.00	75.00	13.00	•	•	•	•	•	X	•	•	•	•
S062080090	62.00	80.00	9.00	•	•	•	X	•	•	•	•	•	•
S062080100	62.00	80.00	10.00	X	X	X	X	X	•	•	•	•	•
S062080120	62.00	80.00	12.00	X	•	X	X	•	•	•	•	•	•
S062082100	62.00	82.00	10.00	X	•	•	X	•	•	•	•	•	•
S062082120	62.00	82.00	12.00	•	•	•	X	•	•	•	•	•	•
S062083090	62.00	83.00	9.00	•	•	•	X	•	•	•	•	•	•
S062085080	62.00	85.00	8.00	•	X	•	X	X	•	•	•	•	•
S062085095	62.00	85.00	9.50	X	•	•	•	•	•	•	•	•	•
S062085100	62.00	85.00	10.00	X	X	X	X	•	X	•	•	•	•
S062085120	62.00	85.00	12.00	X	•	X	X	•	•	•	•	•	•
S062085130	62.00	85.00	13.00	X	•	X	X	X	X	•	•	•	•
S062090100	62.00	90.00	10.00	X	X	X	X	•	•	•	•	•	•
S062090110	62.00	90.00	11.00	X	•	•	•	•	•	•	•	•	•
S062090120	62.00	90.00	12.00	X	•	X	X	•	•	•	•	•	•
S062090130	62.00	90.00	13.00	X	X	X	•	•	•	•	•	•	•
S062092120	62.00	92.00	12.00	•	•	•	X	•	•	•	•	•	•
S062095100	62.00	95.00	10.00	X	•	•	•	•	•	•	•	•	•
S062095130	62.00	95.00	13.00	•	X	•	X	•	•	•	•	•	•
S062100100	62.00	100.00	10.00	X	•	•	•	•	•	•	•	•	•
S062100120	62.00	100.00	12.00	X	•	•	•	•	•	•	•	•	•
S062100130	62.00	100.00	13.00	•	•	X	•	•	X	•	•	•	•
S062101150	62.00	101.00	15.00	•	•	•	X	•	•	•	•	•	•
S062111075	62.00	111.00	7.50	X	•	•	•	•	•	•	•	•	•
S063073050	63.00	73.00	5.00	•	•	•	•	•	•	•	X	•	•
S063075050	63.00	75.00	5.00	•	•	•	•	•	•	•	X	•	•
S063075060	63.00	75.00	6.00	•	•	•	•	X	•	•	•	•	•
S063075090	63.00	75.00	9.00	•	•	•	X	•	•	•	•	•	•
S063080090	63.00	80.00	9.00	•	•	•	X	•	•	•	•	•	•
S063085080	63.00	85.00	8.00	•	•	•	X	•	•	•	•	•	•
S063085100	63.00	85.00	10.00	X	•	2	X	•	•	•	•	•	•
S063085120	63.00	85.00	12.00	X	•	X	X	•	•	•	•	•	•
S063085130	63.00	85.00	13.00	X	•	X	•	•	•	•	•	•	•
S063088100	63.00	88.00	10.00	X	•	•	X	•	•	•	•	•	•
S063090100	63.00	90.00	10.00	X	•	•	X	•	•	•	•	•	•
S063090130	63.00	90.00	13.00	•	•	X	•	•	•	•	•	•	•
S063100130	63.00	100.00	13.00	X	•	•	•	•	•	•	•	•	•
S063110120	63.00	110.00	12.00	X	•	•	•	•	•	•	•	•	•
S064080070	64.00	80.00	7.00	X	•	•	•	•	•	•	•	•	•
S064080080	64.00	80.00	8.00	X	X	•	•	X	•	•	•	•	•
S064080130	64.00	80.00	13.00	•	•	X	X	•	•	•	•	•	•
S064085100	64.00	85.00	10.00	X	•	X	•	•	•	•	•	•	•
S064085120	64.00	85.00	12.00	X	•	•	X	•	•	•	•	•	•
S064085130	64.00	85.00	13.00	X	•	X	•	•	•	•	•	•	•
S064085160	64.00	85.00	16.00	•	•	•	X	•	•	•	•	•	•
S064086100	64.00	86.00	10.00	•	•	•	X	•	•	•	•	•	•

X: EXISTING TOOLING •: ON REQUEST



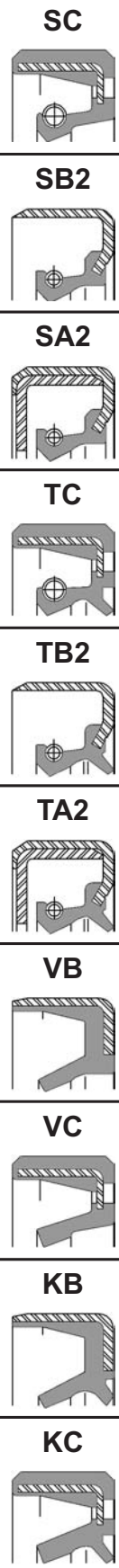







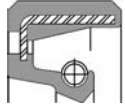
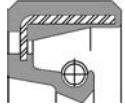





N.B.: MINIMUM LINE ORDER MAY APPLY



## GLOBAL AVAILABILITY LIST

## RADIAL SHAFT SEALS - NBR/STEEL

METRIC SIZE  
SHAFT SEALS

SC 	Ref. Number	Dimensions			DESIGN TYPE									
		d	D	H	SC	SB2	SA2	TC	TB2	TA2	VB	VC	KB	KC
	S064090100	64.00	90.00	10.00	•	•	X	•	•	•	•	•	•	•
	S064090130	64.00	90.00	13.00	•	•	X	X	X	X	•	•	•	•
	S064092130	64.00	92.00	13.00	•	•	•	•	X	•	•	•	•	•
	S064100100	64.00	100.00	10.00	•	•	X	•	•	•	•	•	•	•
	S064100130	64.00	100.00	13.00	•	•	X	•	•	•	•	•	•	•
	S065075050	65.00	75.00	5.00	X	•	•	•	•	•	•	•	•	•
	S065075080	65.00	75.00	8.00	•	•	X	X	•	•	X	•	•	•
	S065077040	65.00	77.00	4.00	•	•	•	•	•	•	X	•	•	•
	S065078120	65.00	78.00	12.00	•	•	•	•	X	•	•	•	•	•
	S065080080	65.00	80.00	8.00	X	X	•	X	X	•	•	•	•	•
	S065080100	65.00	80.00	10.00	X	X	X	X	•	•	•	•	•	•
	S065080120	65.00	80.00	12.00	X	X	X	X	•	•	•	•	•	•
	S065080130	65.00	80.00	13.00	X	•	X	•	•	•	•	•	•	•
	S065082090	65.00	82.00	9.00	•	•	•	X	•	•	•	•	•	•
	S065082120	65.00	82.00	12.00	X	•	•	•	•	•	•	•	•	•
	S065083100	65.00	83.00	10.00	•	•	•	X	X	•	•	•	•	•
	S065084090	65.00	84.00	9.00	•	•	•	X	•	•	•	•	•	•
	S065085050	65.00	85.00	5.00	•	•	•	•	•	•	X	•	•	•
	S065085080	65.00	85.00	8.00	X	X	•	X	•	•	•	•	•	•
	S065085090	65.00	85.00	9.00	X	•	•	•	•	•	•	•	•	•
	S065085100	65.00	85.00	10.00	X	X	X	X	X	•	•	•	•	•
	S065085120	65.00	85.00	12.00	X	X	X	X	X	•	•	•	•	•
	S065085130	65.00	85.00	13.00	X	X	X	X	•	•	•	•	•	•
	S065086095	65.00	86.00	9.50	X	•	•	•	•	•	•	•	•	•
	S065088050	65.00	88.00	5.00	•	•	•	•	•	•	•	X	•	•
	S065088060	65.00	88.00	6.00	•	•	•	•	•	•	X	•	•	•
	S065088100	65.00	88.00	10.00	X	•	•	•	•	•	•	•	•	•
	S065088120	65.00	88.00	12.00	X	•	•	X	X	•	•	X	•	•
	S065089130	65.00	89.00	13.00	•	•	•	X	•	•	•	•	•	•
	S065090080	65.00	90.00	8.00	•	•	•	X	•	•	•	•	•	•
	S065090100	65.00	90.00	10.00	X	X	X	X	X	•	•	•	•	•
	S065090120	65.00	90.00	12.00	X	X	X	X	•	X	•	•	•	•
	S065090130	65.00	90.00	13.00	X	X	X	X	X	•	•	•	•	•
	S065090150	65.00	90.00	15.00	•	•	•	X	X	•	•	•	•	•
	S065092120	65.00	92.00	12.00	X	•	•	•	•	•	•	•	•	•
	S065092130	65.00	92.00	13.00	X	•	•	•	•	•	•	•	•	•
	S065095100	65.00	95.00	10.00	X	X	X	X	•	•	•	•	•	•
	S065095120	65.00	95.00	12.00	•	•	•	X	•	•	•	•	•	•
	S065095130	65.00	95.00	13.00	X	•	X	X	•	•	•	•	•	•
	S065095140	65.00	95.00	14.00	•	•	•	X	•	•	•	•	•	•
	S065095160	65.00	95.00	16.00	X	•	•	•	•	•	•	•	•	•
	S065098150	65.00	98.00	15.00	•	•	•	X	•	•	•	•	•	•
	S065100100	65.00	100.00	10.00	X	X	X	X	•	•	•	•	•	•
	S065100120	65.00	100.00	12.00	X	•	X	X	•	•	•	•	•	•
	S065100130	65.00	100.00	13.00	X	•	X	X	X	X	•	•	•	•
	S065110100	65.00	110.00	10.00	X	•	•	X	•	•	•	•	•	•
	S065110130	65.00	110.00	13.00	X	•	•	•	•	•	•	•	•	•
	S065115150	65.00	115.00	15.00	X	•	•	•	•	•	•	•	•	•

X: EXISTING TOOLING    •: ON REQUEST

N.B.: MINIMUM LINE ORDER MAY APPLY

Tel.: (888) 238-5885  
Fax: (888) 238-1664

**SS 197**

[www.sealsonline.com](http://www.sealsonline.com)



**M**

## RADIAL SHAFT SEALS - NBR/STEEL

## GLOBAL AVAILABILITY LIST

Ref. Number	Dimensions			DESIGN TYPE									SC
	d	D	H	SC	SB2	SA2	TC	TB2	TA2	VB	VC	KB	
S065120120	65.00	120.00	12.00	X	•	•	•	•	•	•	•	•	•
S065120130	65.00	120.00	13.00	•	•	•	X	•	•	•	•	•	•
S065125120	65.00	125.00	12.00	X	•	•	•	•	•	•	•	•	•
S065140100	65.00	140.00	10.00	•	•	•	X	•	•	•	•	•	•
S066080170	66.00	80.00	17.00	•	•	•	X	•	•	•	•	•	•
S066086095	66.00	86.00	9.50	X	•	•	•	•	•	•	•	•	•
S066090100	66.00	90.00	10.00	X	•	X	•	•	•	•	•	•	•
S066090130	66.00	90.00	13.00	•	•	X	•	•	•	•	•	•	•
S066100110	66.00	100.00	11.00	X	•	•	•	•	•	•	•	•	•
S067080067	67.00	80.00	6.70	X	•	•	•	•	•	•	•	•	•
S067080100	67.00	80.00	10.00	•	X	•	•	•	•	•	•	•	•
S067080130	67.00	80.00	13.00	•	•	X	•	•	•	•	•	•	•
S067085100	67.00	85.00	10.00	•	•	X	•	•	•	•	•	•	•
S067089130	67.00	89.00	13.00	•	•	•	•	X	•	•	•	•	•
S067090100	67.00	90.00	10.00	•	•	X	•	•	•	•	•	•	•
S067090130	67.00	90.00	13.00	•	•	X	•	•	•	•	•	•	•
S067095100	67.00	95.00	10.00	X	•	•	•	•	•	•	•	•	•
S067095130	67.00	95.00	13.00	•	•	X	•	•	•	•	•	•	•
S068072070	68.00	72.00	7.00	•	•	•	X	•	•	•	•	•	•
S068080080	68.00	80.00	8.00	•	X	•	X	•	•	•	•	•	•
S068080100	68.00	80.00	10.00	•	X	•	X	•	•	•	•	•	•
S068082070	68.00	82.00	7.00	•	•	•	X	•	•	•	•	•	•
S068082100	68.00	82.00	10.00	X	•	•	X	•	•	•	•	•	•
S068082120	68.00	82.00	12.00	•	•	•	X	•	•	•	•	•	•
S068083100	68.00	83.00	10.00	•	•	•	X	•	•	•	•	•	•
S068085080	68.00	85.00	8.00	X	•	•	•	X	•	•	•	•	•
S068085100	68.00	85.00	10.00	X	X	•	X	•	•	•	•	•	•
S068085130	68.00	85.00	13.00	X	•	•	X	•	•	•	•	•	•
S068086100	68.00	86.00	10.00	•	•	•	X	•	•	•	•	•	•
S068087080	68.00	87.00	8.00	•	•	•	X	•	•	•	•	•	•
S068088090	68.00	88.00	9.00	•	•	•	X	•	•	•	•	•	•
S068088095	68.00	88.00	9.50	•	•	•	•	X	•	•	•	•	•
S068088100	68.00	88.00	10.00	•	•	•	•	•	X	•	•	•	•
S068090100	68.00	90.00	10.00	X	X	X	X	X	X	•	•	•	•
S068090120	68.00	90.00	12.00	X	•	X	X	X	•	•	•	•	•
S068090130	68.00	90.00	13.00	X	X	•	X	X	X	•	•	•	•
S068092120	68.00	92.00	12.00	•	•	•	•	X	•	•	•	•	•
S068094080	68.00	94.00	8.00	•	•	•	X	•	•	•	•	•	•
S068095100	68.00	95.00	10.00	X	•	•	•	•	•	•	•	•	•
S068095120	68.00	95.00	12.00	X	•	•	•	•	•	•	•	•	•
S068095130	68.00	95.00	13.00	X	•	X	X	•	•	•	•	•	•
S068100100	68.00	100.00	10.00	X	•	•	X	•	•	•	•	•	•
S068100120	68.00	100.00	12.00	•	•	X	X	•	•	•	•	•	•
S068100130	68.00	100.00	13.00	X	•	•	•	•	•	•	•	•	•
S068110130	68.00	110.00	13.00	•	•	X	X	X	•	•	•	•	•
S069085100	69.00	85.00	10.00	•	•	•	•	X	•	•	•	•	•
S069085120	69.00	85.00	12.00	•	•	•	•	•	X	•	•	•	•
S069088100	69.00	88.00	10.00	•	•	•	•	•	•	X	•	•	•

X: EXISTING TOOLING •: ON REQUEST



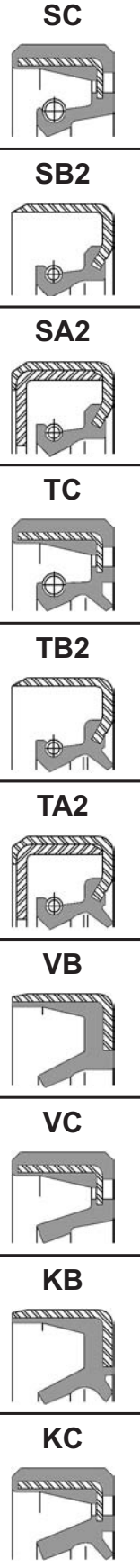





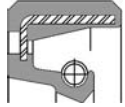

N.B.: MINIMUM LINE ORDER MAY APPLY



## GLOBAL AVAILABILITY LIST

## RADIAL SHAFT SEALS - NBR/STEEL

METRIC SIZE  
SHAFT SEALS

SC 	Ref. Number	Dimensions			DESIGN TYPE									
		d	D	H	SC	SB2	SA2	TC	TB2	TA2	VB	VC	KB	KC
	S069090100	69.00	90.00	10.00	X	•	•	•	•	•	•	•	•	•
	S070078050	70.00	78.00	5.00	•	•	•	•	•	•	•	X	•	•
	S070080050	70.00	80.00	5.00	•	•	•	•	•	•	•	X	•	•
	S070080060	70.00	80.00	6.00	X	•	•	•	•	•	•	•	•	•
	S070080100	70.00	80.00	10.00	•	•	•	X	•	•	•	•	•	•
	S070082070	70.00	82.00	7.00	•	•	•	•	•	•	X	•	•	•
	S070083050	70.00	83.00	5.00	X	•	•	•	•	•	•	•	•	•
	S070084080	70.00	84.00	8.00	•	•	•	X	•	•	•	•	•	•
	S070085060	70.00	85.00	6.00	X	•	•	•	•	•	•	•	•	•
	S070085070	70.00	85.00	7.00	X	•	•	•	•	•	•	•	•	•
	S070085080	70.00	85.00	8.00	X	X	•	X	X	•	•	•	•	•
	S070085085	70.00	85.00	8.50	•	•	•	•	•	•	•	X	•	•
	S070085090	70.00	85.00	9.00	•	•	•	X	•	•	•	•	•	•
	S070085100	70.00	85.00	10.00	X	X	X	X	•	•	•	•	•	•
	S070085160	70.00	85.00	16.00	•	•	•	•	•	•	•	•	•	•
	S070086085	70.00	86.00	8.50	X	•	•	•	•	•	•	•	•	•
	S070086100	70.00	86.00	10.00	•	•	•	•	X	•	•	•	•	•
	S070087100	70.00	87.00	10.00	•	•	•	X	•	•	•	•	•	•
	S070088120	70.00	88.00	12.00	•	•	•	X	X	•	•	•	•	•
	S070089120	70.00	89.00	12.00	•	•	•	X	•	•	•	•	•	•
	S070090070	70.00	90.00	7.00	X	•	•	X	•	•	•	•	•	•
	S070090080	70.00	90.00	8.00	X	•	•	•	•	•	•	•	•	•
	S070090100	70.00	90.00	10.00	X	X	X	X	X	X	•	•	•	•
	S070090120	70.00	90.00	12.00	X	X	X	X	•	X	•	•	•	•
	S070090130	70.00	90.00	13.00	X	X	X	X	•	•	•	•	•	•
	S070092050	70.00	92.00	5.00	•	•	•	•	•	•	•	X	•	•
	S070092070	70.00	92.00	7.00	•	•	•	X	•	•	•	•	•	•
	S070092090	70.00	92.00	9.00	•	•	•	X	•	•	•	•	•	•
	S070092100	70.00	92.00	10.00	•	X	•	•	•	•	•	•	•	•
	S070092120	70.00	92.00	12.00	X	•	•	X	•	•	•	•	•	•
	S070092130	70.00	92.00	13.00	2	•	•	X	X	•	•	•	•	•
	S070093120	70.00	93.00	12.00	•	•	•	X	•	•	•	•	•	•
	S070095050	70.00	95.00	5.00	•	•	•	•	•	•	•	X	•	•
	S070095100	70.00	95.00	10.00	X	•	X	X	•	•	•	•	•	•
	S070095120	70.00	95.00	12.00	X	•	•	X	•	•	•	•	•	•
	S070095130	70.00	95.00	13.00	X	X	X	X	X	X	•	•	•	•
	S070095140	70.00	95.00	14.00	•	•	•	X	•	•	•	•	•	•
	S070096130	70.00	96.00	13.00	X	•	•	•	•	•	•	•	•	•
	S070095050	70.00	95.00	5.00	•	•	•	•	•	•	•	•	X	•
	S070098130	70.00	98.00	13.00	•	•	X	•	•	•	•	•	•	•
	S070100060	70.00	100.00	6.00	X	•	•	•	•	•	•	•	•	•
	S070100080	70.00	100.00	8.00	X	•	•	X	•	•	•	•	•	•
	S070100100	70.00	100.00	10.00	X	X	X	X	•	•	•	•	•	•
	S070100120	70.00	100.00	12.00	X	X	X	X	X	•	•	•	•	•
	S070100130	70.00	100.00	13.00	X	X	X	X	•	•	•	•	•	•
	S070100140	70.00	100.00	14.00	•	•	•	X	•	•	•	•	•	•
	S070100150	70.00	100.00	15.00	•	•	•	X	•	•	•	•	•	•
S070100160	70.00	100.00	16.00	X	•	•	•	•	•	•	•	•	•	
S070105130	70.00	105.00	13.00	X	•	X	X	•	•	•	•	•	•	

X: EXISTING TOOLING    •: ON REQUEST

N.B.: MINIMUM LINE ORDER MAY APPLY

Tel.: (204) 783-9617  
Fax: (204) 783-6091

**SS 199**

[www.sealsonline.com](http://www.sealsonline.com)



**M**



## RADIAL SHAFT SEALS - NBR/STEEL

## GLOBAL AVAILABILITY LIST

Ref. Number	Dimensions			DESIGN TYPE									SC
	d	D	H	SC	SB2	SA2	TC	TB2	TA2	VB	VC	KB	
S070105140	70.00	105.00	14.00	X	•	•	•	•	•	•	•	•	•
S070105150	70.00	105.00	15.00	•	•	•	X	•	•	•	•	•	•
S070110080	70.00	110.00	8.00	X	•	•	X	•	•	•	•	•	•
S070110100	70.00	110.00	10.00	X	X	•	X	•	•	•	•	•	•
S070110120	70.00	110.00	12.00	X	X	•	X	•	•	•	•	•	•
S070110130	70.00	110.00	13.00	X	X	X	X	•	•	•	•	•	•
S070110150	70.00	110.00	15.00	X	•	•	•	•	•	•	•	•	•
S070111130	70.00	111.00	13.00	X	•	•	•	•	•	•	•	•	•
S070112120	70.00	112.00	12.00	X	•	•	•	•	•	•	•	•	•
S070115130	70.00	115.00	13.00	•	•	•	X	•	•	•	•	•	•
S070115150	70.00	115.00	15.00	X	•	•	X	•	•	•	•	•	•
S070120100	70.00	120.00	10.00	•	•	•	X	•	•	•	•	•	•
S070120120	70.00	120.00	12.00	X	•	•	•	•	•	•	•	•	•
S070120130	70.00	120.00	13.00	X	X	X	•	•	•	•	•	•	•
S070125120	70.00	125.00	12.00	X	•	•	X	•	•	•	•	•	•
S070135120	70.00	135.00	12.00	X	•	•	•	•	•	•	•	•	•
S070150120	70.00	150.00	12.00	X	•	•	•	•	•	•	•	•	•
S071083120	71.00	83.00	12.00	X	•	•	•	•	•	•	•	•	•
S071086050	71.00	86.00	5.00	•	•	•	•	•	•	X	•	•	•
S071088080	71.00	88.00	8.00	X	•	•	X	•	•	•	•	•	•
S072084070	72.00	84.00	7.00	•	X	•	•	X	•	•	•	•	•
S072085080	72.00	85.00	8.00	X	•	•	•	•	•	•	•	•	•
S072085100	72.00	85.00	10.00	X	•	•	•	•	•	•	•	•	•
S072086070	72.00	86.00	7.00	•	•	•	X	•	•	•	•	•	•
S072088080	72.00	88.00	8.00	•	•	•	X	•	•	•	•	•	•
S072090080	72.00	90.00	8.00	X	•	•	•	•	•	•	•	•	•
S072090100	72.00	90.00	10.00	X	X	X	X	X	X	•	•	•	•
S072090130	72.00	90.00	13.00	•	•	X	•	•	•	•	•	•	•
S072092120	72.00	92.00	12.00	•	•	•	X	•	•	•	•	•	•
S072094120	72.00	94.00	12.00	•	•	•	X	•	•	•	•	•	•
S072095100	72.00	95.00	10.00	X	X	X	X	•	•	•	•	•	•
S072095120	72.00	95.00	12.00	X	•	X	•	•	•	•	•	•	•
S072095130	72.00	95.00	13.00	X	X	X	•	X	•	•	•	•	•
S072096090	72.00	96.00	9.00	•	•	•	X	•	•	•	•	•	•
S072100100	72.00	100.00	10.00	X	X	X	X	•	•	•	•	•	•
S072100120	72.00	100.00	12.00	•	•	X	X	•	•	•	•	•	•
S072100130	72.00	100.00	13.00	X	•	X	X	•	•	•	•	•	•
S072105100	72.00	105.00	10.00	•	•	•	X	•	•	•	•	•	•
S072105130	72.00	105.00	13.00	•	•	•	X	X	•	•	•	•	•
S072110120	72.00	110.00	12.00	X	•	•	•	•	•	•	•	•	•
S072110130	72.00	110.00	13.00	•	•	X	•	•	•	•	•	•	•
S073090080	73.00	90.00	8.00	•	•	•	•	X	•	•	•	•	•
S073095100	73.00	95.00	10.00	X	•	X	•	•	•	•	•	•	•
S073096090	73.00	96.00	9.00	•	•	•	X	•	•	•	•	•	•
S073100130	73.00	100.00	13.00	•	•	X	•	•	•	•	•	•	•
S074088100	74.00	88.00	10.00	X	•	•	•	•	•	•	•	•	•
S074090100	74.00	90.00	10.00	X	X	X	•	X	•	•	•	•	•
S074093120	74.00	93.00	12.00	•	•	•	X	•	•	•	•	•	•

X: EXISTING TOOLING •: ON REQUEST



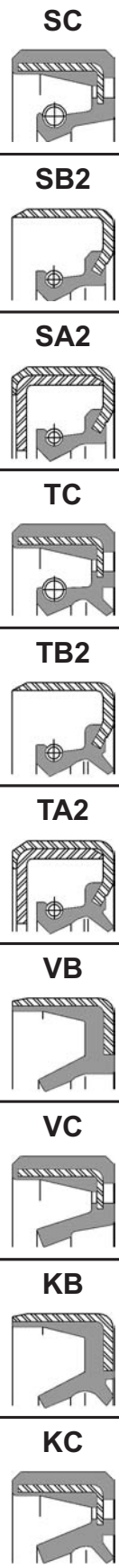







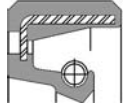





N.B.: MINIMUM LINE ORDER MAY APPLY



## GLOBAL AVAILABILITY LIST

## RADIAL SHAFT SEALS - NBR/STEEL

**METRIC SIZE  
SHAFT SEALS**

SC 	Ref. Number	Dimensions			DESIGN TYPE									
		d	D	H	SC	SB2	SA2	TC	TB2	TA2	VB	VC	KB	KC
	S074095070	74.00	95.00	7.00	•	•	•	•	•	•	•	X	•	•
	S074095100	74.00	95.00	10.00	X	•	X	X	•	•	•	•	•	•
	S074095130	74.00	95.00	13.00	•	X	•	•	•	•	•	•	•	•
	S074096090	74.00	96.00	9.00	•	•	•	X	•	•	•	•	•	•
	S074098120	74.00	98.00	12.00	•	•	•	X	•	•	•	•	•	•
	S074100130	74.00	100.00	13.00	•	X	X	•	•	•	•	•	•	•
	S074105120	74.00	105.00	12.00	X	•	•	•	•	•	•	•	•	•
	S074135150	74.00	135.00	15.00	X	•	•	•	•	•	•	•	•	•
	S075090050	75.00	90.00	5.00	•	•	•	•	•	•	X	•	•	•
	S075090060	75.00	90.00	6.00	•	•	•	X	•	•	•	X	•	•
	S075090070	75.00	90.00	7.00	•	X	•	X	•	•	•	•	•	•
	S075090080	75.00	90.00	8.00	2	•	•	X	•	•	•	•	•	•
	S075090100	75.00	90.00	10.00	X	•	X	X	•	•	•	•	•	•
	S075090120	75.00	90.00	12.00	X	•	X	•	•	•	•	•	•	•
	S075090130	75.00	90.00	13.00	X	•	•	•	X	•	•	•	•	•
	S075090150	75.00	90.00	15.00	•	•	•	•	•	•	•	•	•	•
	S075092070	75.00	92.00	7.00	X	•	•	•	•	•	•	•	•	•
	S075092120	75.00	92.00	12.00	•	•	•	X	•	•	•	•	•	•
	S075095050	75.00	95.00	5.00	•	X	•	•	•	•	•	•	•	•
	S075095070	75.00	95.00	7.00	•	•	•	X	•	•	•	•	•	•
	S075095080	75.00	95.00	8.00	X	•	•	X	•	•	•	•	•	•
	S075095090	75.00	95.00	9.00	•	•	•	X	•	•	•	•	•	•
	S075095100	75.00	95.00	10.00	X	X	X	X	X	•	•	•	•	•
	S075095120	75.00	95.00	12.00	X	X	X	X	X	•	•	•	•	•
	S075095130	75.00	95.00	13.00	X	X	X	X	•	•	•	•	•	•
	S075095140	75.00	95.00	14.00	•	•	•	•	•	•	•	•	•	•
	S075095150	75.00	95.00	15.00	•	•	•	•	•	•	•	•	•	•
	S075096110	75.00	96.00	11.00	•	•	•	•	X	•	•	•	•	•
	S075098120	75.00	98.00	12.00	•	•	•	X	•	•	•	•	•	•
	S075100070	75.00	100.00	7.00	X	•	•	•	•	•	•	•	•	•
	S075100080	75.00	100.00	8.00	•	•	•	•	X	•	•	•	•	•
	S075100100	75.00	100.00	10.00	X	X	X	X	X	X	•	•	•	•
	S075100120	75.00	100.00	12.00	X	X	X	X	•	•	•	•	•	•
	S075100130	75.00	100.00	13.00	X	X	X	X	X	2	•	•	•	•
	S075100140	75.00	100.00	14.00	•	•	•	X	•	•	•	•	•	•
	S075100150	75.00	100.00	15.00	•	•	•	X	•	•	•	•	•	•
	S075101120	75.00	101.00	12.00	X	•	•	•	•	•	•	•	•	•
	S075101130	75.00	101.00	13.00	•	•	•	X	•	•	•	•	•	•
	S075102120	75.00	102.00	12.00	X	•	•	X	•	•	•	•	•	•
	S075105120	75.00	105.00	12.00	X	•	X	X	X	X	•	•	•	•
	S075105130	75.00	105.00	13.00	X	X	X	X	•	•	•	•	•	•
	S075105150	75.00	105.00	15.00	X	•	•	X	•	•	•	•	•	•
	S075110100	75.00	110.00	10.00	X	X	•	X	•	•	•	•	•	•
	S075110120	75.00	110.00	12.00	X	X	•	X	X	•	•	•	•	•
	S075110130	75.00	110.00	13.00	X	X	X	X	X	•	•	•	•	•
	S075112120	75.00	112.00	12.00	X	•	•	•	•	•	•	•	•	•
	S075115095	75.00	115.00	9.50	X	•	•	•	•	•	•	•	•	•
	S075115100	75.00	115.00	10.00	X	•	•	•	•	•	•	•	•	•

X: EXISTING TOOLING    •: ON REQUEST

N.B.: MINIMUM LINE ORDER MAY APPLY

**Tel.: (780) 414-1871**  
**Fax: (780) 487-5419**

**SS 201**

[www.sealsonline.com](http://www.sealsonline.com)



## RADIAL SHAFT SEALS - NBR/STEEL

## GLOBAL AVAILABILITY LIST

Ref. Number	Dimensions			DESIGN TYPE									SC 
	d	D	H	SC	SB2	SA2	TC	TB2	TA2	VB	VC	KB	
S075115120	75.00	115.00	12.00	X	•	•	•	•	•	•	•	•	•
S075115130	75.00	115.00	13.00	•	•	X	•	•	X	•	•	•	•
S075115160	75.00	115.00	16.00	X	•	•	•	•	•	•	•	•	•
S075120120	75.00	120.00	12.00	X	•	•	•	•	•	•	•	•	•
S075120130	75.00	120.00	13.00	•	•	•	•	X	•	•	•	•	•
S075121130	75.00	121.00	13.00	•	•	•	•	X	•	•	•	•	•
S075122120	75.00	122.00	12.00	•	X	•	•	•	•	•	•	•	•
S075125120	75.00	125.00	12.00	X	•	•	•	•	•	•	•	•	•
S075130120	75.00	130.00	12.00	X	•	•	•	•	•	•	•	•	•
S075130130	75.00	130.00	13.00	X	•	•	•	•	•	•	•	•	•
S075135130	75.00	135.00	13.00	X	•	•	•	•	•	•	•	•	•
S076094100	76.00	94.00	10.00	•	•	•	•	X	•	•	•	•	•
S076095100	76.00	95.00	10.00	•	X	•	•	•	•	•	•	•	•
S076098120	76.00	98.00	12.00	•	•	•	X	•	•	•	•	•	•
S076100100	76.00	100.00	10.00	X	•	•	•	•	•	•	•	•	•
S076100120	76.00	100.00	12.00	•	•	•	X	•	•	•	•	•	•
S076100130	76.00	100.00	13.00	•	•	X	•	•	•	•	•	•	•
S076100160	76.00	100.00	16.00	•	•	•	X	•	•	•	•	•	•
S076102120	76.00	102.00	12.00	X	•	•	•	•	•	•	•	•	•
S076105120	76.00	105.00	12.00	•	•	•	X	•	•	•	•	•	•
S076105130	76.00	105.00	13.00	X	•	•	X	•	•	•	•	•	•
S076110130	76.00	110.00	13.00	•	•	X	•	•	•	•	•	•	•
S076120120	76.00	120.00	12.00	X	•	•	•	•	•	•	•	•	•
S077093100	77.00	93.00	10.00	•	•	•	•	X	•	•	•	•	•
S077095100	77.00	95.00	10.00	X	•	X	•	•	•	•	•	•	•
S077095130	77.00	95.00	13.00	•	•	X	•	•	•	•	•	•	•
S077100100	77.00	100.00	10.00	X	•	X	•	•	•	•	•	•	•
S078090080	78.00	90.00	8.00	X	•	•	•	•	•	•	•	•	•
S078095110	78.00	95.00	11.00	X	•	•	•	•	•	•	•	•	•
S078095130	78.00	95.00	13.00	•	•	X	•	•	•	•	•	•	•
S078098120	78.00	98.00	12.00	•	•	•	X	•	•	•	•	•	•
S078100100	78.00	100.00	10.00	X	•	X	X	•	X	•	•	•	•
S078100120	78.00	100.00	12.00	•	•	X	X	•	•	•	•	•	•
S078100130	78.00	100.00	13.00	X	•	•	X	X	•	•	•	•	•
S078105130	78.00	105.00	13.00	X	•	X	•	•	•	•	•	•	•
S078105150	78.00	105.00	15.00	X	•	•	•	•	•	•	•	•	•
S078110120	78.00	110.00	12.00	X	•	•	X	•	•	•	•	•	•
S078110130	78.00	110.00	13.00	X	•	X	X	•	•	•	•	•	•
S078115100	78.00	115.00	10.00	•	•	•	X	•	•	•	•	•	•
S078115130	78.00	115.00	13.00	•	•	X	•	•	•	•	•	•	•
S080090050	80.00	90.00	5.00	•	•	•	•	•	•	•	X	•	•
S080090120	80.00	90.00	12.00	•	•	•	•	•	•	•	X	•	•
S080095050	80.00	95.00	5.00	•	•	•	•	•	•	X	X	•	•
S080095080	80.00	95.00	8.00	X	X	•	X	•	•	•	•	•	•
S080095100	80.00	95.00	10.00	X	•	•	•	•	•	•	•	•	•
S080095110	80.00	95.00	11.00	•	•	•	•	X	•	•	•	•	•
S080100070	80.00	100.00	7.00	•	•	•	•	•	•	X	•	•	•
S080100080	80.00	100.00	8.00	•	•	•	•	•	•	X	•	•	•

X: EXISTING TOOLING •: ON REQUEST











N.B.: MINIMUM LINE ORDER MAY APPLY

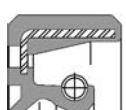

## GLOBAL AVAILABILITY LIST

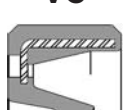
## RADIAL SHAFT SEALS - NBR/STEEL

METRIC SIZE  
SHAFT SEALS

SC 	Ref. Number	Dimensions			DESIGN TYPE									
		d	D	H	SC	SB2	SA2	TC	TB2	TA2	VB	VC	KB	KC
	S080100090	80.00	100.00	9.00	•	X	•	•	•	•	•	•	•	•
	S080100100	80.00	100.00	10.00	X	X	X	X	X	X	X	•	•	•
	S080100120	80.00	100.00	12.00	X	X	X	X	X	X	•	•	•	•
	S080100130	80.00	100.00	13.00	X	X	X	X	X	X	•	•	•	•
	S080100140	80.00	100.00	14.00	X	•	•	•	•	•	•	•	•	•
	S080100150	80.00	100.00	15.00	•	•	•	X	•	•	•	•	•	•
	S080100180	80.00	100.00	18.00	•	•	•	X	•	•	•	•	•	•
	S080105070	80.00	105.00	7.00	•	•	•	•	•	•	•	X	•	•
	S080105085	80.00	105.00	8.50	•	•	•	X	•	•	•	•	•	•
	S080105100	80.00	105.00	10.00	X	•	•	X	•	•	•	•	•	•
	S080105120	80.00	105.00	12.00	X	•	X	X	X	•	•	•	•	•
	S080105130	80.00	105.00	13.00	X	X	X	X	X	•	•	•	•	•
	S080105140	80.00	105.00	14.00	•	•	•	X	•	•	•	•	•	•
	S080105150	80.00	105.00	15.00	•	X	•	X	•	•	•	•	•	•
	S080106080	80.00	106.00	8.00	•	•	•	•	•	•	X	•	•	•
	S080108100	80.00	108.00	10.00	•	•	•	•	•	X	•	•	•	•
	S080108150	80.00	108.00	15.00	•	•	•	X	•	•	•	•	•	•
	S080110100	80.00	110.00	10.00	X	X	X	X	•	•	X	•	•	•
	S080110120	80.00	110.00	12.00	X	X	X	X	X	•	•	•	•	•
	S080110130	80.00	110.00	13.00	X	X	X	X	X	X	•	•	•	•
	S080110140	80.00	110.00	14.00	X	•	X	•	•	•	•	•	•	•
	S080110150	80.00	110.00	15.00	•	•	•	X	•	•	•	•	•	•
	S080113120	80.00	113.00	12.00	X	•	•	•	•	•	•	•	•	•
	S080115100	80.00	115.00	10.00	X	•	•	•	•	•	•	•	•	•
	S080115120	80.00	115.00	12.00	X	•	•	•	•	•	•	•	•	•
	S080115130	80.00	115.00	13.00	•	•	•	X	•	•	•	•	•	•
	S080115150	80.00	115.00	15.00	•	•	•	X	•	•	•	•	•	•
	S080120120	80.00	120.00	12.00	•	•	X	X	•	•	•	•	•	•
	S080120130	80.00	120.00	13.00	X	X	X	X	•	•	•	•	•	•
	S080125100	80.00	125.00	10.00	•	•	•	X	•	•	•	•	•	•
	S080125120	80.00	125.00	12.00	X	•	•	•	•	•	•	•	•	•
	S080125130	80.00	125.00	13.00	X	X	X	X	•	•	•	•	•	•
	S080125140	80.00	125.00	14.00	•	•	•	X	•	•	•	•	•	•
	S080130130	80.00	130.00	13.00	X	•	•	•	X	•	•	•	•	•
	S080140130	80.00	140.00	13.00	X	•	•	X	•	•	•	•	•	•
	S080145130	80.00	145.00	13.00	X	•	•	•	•	•	•	•	•	•
	S081088380	81.00	88.00	38.00	•	•	•	•	•	•	•	X	•	•
	S081100100	81.00	100.00	10.00	•	•	X	•	•	•	•	•	•	•
	S081100130	81.00	100.00	13.00	•	•	X	•	•	•	•	•	•	•
	S082100080	82.00	100.00	8.00	X	•	•	•	•	•	•	•	•	•
	S082105100	82.00	105.00	10.00	•	•	•	X	•	•	•	•	•	•
	S082105120	82.00	105.00	12.00	X	•	•	X	•	•	•	•	•	•
	S082105130	82.00	105.00	13.00	•	•	X	X	•	•	•	•	•	•
	S082105140	82.00	105.00	14.00	X	•	•	•	•	•	•	•	•	•
	S082110120	82.00	110.00	12.00	X	•	X	•	•	•	•	•	•	•
	S082110130	82.00	110.00	13.00	•	•	X	•	•	•	•	•	•	•
	S083110120	83.00	110.00	12.00	•	•	X	•	•	•	•	•	•	•
	S083110130	83.00	110.00	13.00	X	•	X	•	•	•	•	•	•	•

X: EXISTING TOOLING    •: ON REQUEST

N.B.: MINIMUM LINE ORDER MAY APPLY

Tel.: (604) 278-6808  
Fax: (604) 278-6180

**SS 203**

[www.sealsonline.com](http://www.sealsonline.com)



## RADIAL SHAFT SEALS - NBR/STEEL

## GLOBAL AVAILABILITY LIST

Ref. Number	Dimensions			DESIGN TYPE									SC
	d	D	H	SC	SB2	SA2	TC	TB2	TA2	VB	VC	KB	
S084105120	84.00	105.00	12.00	•	•	•	X	•	•	•	•	•	•
S084105130	84.00	105.00	13.00	•	•	X	•	•	•	•	•	•	•
S084110120	84.00	110.00	12.00	•	•	X	•	•	•	•	•	•	•
S084110160	84.00	110.00	16.00	•	•	•	X	•	•	•	•	•	•
S085100060	85.00	100.00	6.00	•	•	•	X	•	•	•	•	•	•
S085100070	85.00	100.00	7.00	X	•	•	•	•	•	•	•	•	•
S085100090	85.00	100.00	9.00	X	X	•	•	•	•	•	•	•	•
S085100100	85.00	100.00	10.00	X	•	•	X	•	•	•	•	•	•
S085100120	85.00	100.00	12.00	X	•	X	X	X	•	•	•	•	•
S085100130	85.00	100.00	13.00	•	•	X	X	•	•	•	•	•	•
S085102090	85.00	102.00	9.00	•	•	•	X	•	•	•	•	•	•
S085105080	85.00	105.00	8.00	X	•	•	•	•	•	•	•	•	•
S085105090	85.00	105.00	9.00	•	•	•	•	•	•	•	X	•	•
S085105100	85.00	105.00	10.00	X	X	X	X	X	•	•	•	•	•
S085105120	85.00	105.00	12.00	X	X	•	X	•	•	•	•	•	•
S085105130	85.00	105.00	13.00	X	X	X	X	X	•	•	•	•	•
S085110100	85.00	110.00	10.00	X	•	•	2	•	•	•	•	•	•
S085110120	85.00	110.00	12.00	X	X	X	X	X	X	•	•	•	•
S085110130	85.00	110.00	13.00	X	X	X	X	X	X	•	•	•	•
S085110140	85.00	110.00	14.00	•	•	X	•	•	•	•	•	•	•
S085110150	85.00	110.00	15.00	X	•	X	X	•	•	•	•	•	•
S085110160	85.00	110.00	16.00	•	X	•	•	•	•	•	•	•	•
S085115130	85.00	115.00	13.00	X	•	X	X	•	•	•	•	•	•
S085115150	85.00	115.00	15.00	X	•	•	X	•	•	•	•	•	•
S085115160	85.00	115.00	16.00	•	•	•	X	•	•	•	•	•	•
S085120100	85.00	120.00	10.00	•	•	•	X	•	•	•	•	•	•
S085120120	85.00	120.00	12.00	X	X	X	X	•	•	•	•	•	•
S085120130	85.00	120.00	13.00	X	X	X	X	X	•	•	•	•	•
S085120150	85.00	120.00	15.00	•	X	X	X	•	•	•	•	•	•
S085120170	85.00	120.00	17.00	•	•	•	X	•	•	•	•	•	•
S085124120	85.00	124.00	12.00	•	•	•	X	•	•	•	•	•	•
S085125070	85.00	125.00	7.00	X	•	•	•	•	•	•	•	•	•
S085125120	85.00	125.00	12.00	X	•	•	•	•	•	•	•	•	•
S085125130	85.00	125.00	13.00	•	•	X	X	•	•	•	•	•	•
S085125140	85.00	125.00	14.00	•	•	•	X	•	•	•	•	•	•
S085126130	85.00	126.00	13.00	X	•	•	•	•	•	•	•	•	•
S085130100	85.00	130.00	10.00	•	•	•	X	•	•	•	•	•	•
S085130120	85.00	130.00	12.00	X	•	•	X	•	•	•	•	•	•
S085130127	85.00	130.00	12.70	X	•	•	•	•	•	•	•	•	•
S085130130	85.00	130.00	13.00	•	X	X	X	•	•	•	•	•	•
S085140120	85.00	140.00	12.00	X	•	•	X	•	•	•	•	•	•
S085140140	85.00	140.00	14.00	•	•	•	X	•	•	•	•	•	•
S085150120	85.00	150.00	12.00	X	•	•	X	•	•	•	•	•	•
S085150130	85.00	150.00	13.00	X	X	•	•	•	•	•	•	•	•
S085155120	85.00	155.00	12.00	X	•	•	•	•	•	•	•	•	•
S085195150	85.00	195.00	15.00	•	•	•	X	•	•	•	•	•	•
S086105130	86.00	105.00	13.00	X	•	•	•	•	•	•	•	•	•
S086110130	86.00	110.00	13.00	X	X	X	•	X	•	X	•	•	•

X: EXISTING TOOLING •: ON REQUEST



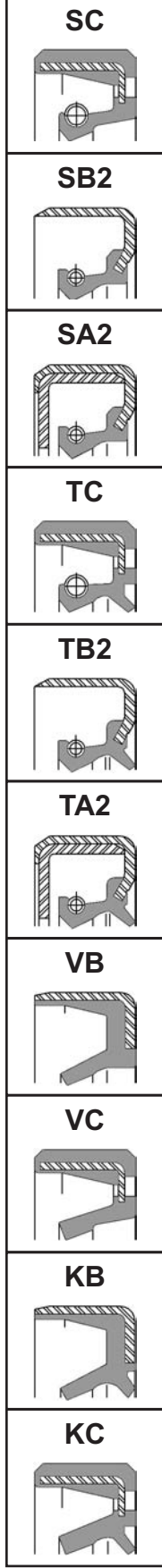





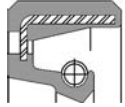

N.B.: MINIMUM LINE ORDER MAY APPLY



## GLOBAL AVAILABILITY LIST

## RADIAL SHAFT SEALS - NBR/STEEL

METRIC SIZE  
SHAFT SEALS

SC 	Ref. Number	Dimensions			DESIGN TYPE									
		d	D	H	SC	SB2	SA2	TC	TB2	TA2	VB	VC	KB	KC
	S086120150	86.00	120.00	15.00	•	•	•	•	•	•	•	•	•	•
	S087100130	87.00	100.00	13.00	•	•	X	•	•	•	•	•	•	•
	S087110100	87.00	110.00	10.00	•	•	X	•	•	X	•	•	•	•
	S087110130	87.00	110.00	13.00	X	•	X	•	•	•	•	•	•	•
	S088100130	88.00	100.00	13.00	X	•	•	•	•	•	•	•	•	•
	S088105120	88.00	105.00	12.00	X	•	•	•	•	•	•	•	•	•
	S088108110	88.00	108.00	11.00	•	•	•	X	•	•	•	•	•	•
	S088110100	88.00	110.00	10.00	X	•	•	•	•	•	•	•	•	•
	S088110120	88.00	110.00	12.00	X	•	•	•	•	•	•	•	•	•
	S088110130	88.00	110.00	13.00	X	•	X	•	•	•	•	•	•	•
	S088115090	88.00	115.00	9.00	X	•	•	•	•	•	•	•	•	•
	S088115095	88.00	115.00	9.50	•	•	•	•	X	•	•	•	•	•
	S088115120	88.00	115.00	12.00	•	•	•	X	•	•	•	•	•	•
	S088120100	88.00	120.00	10.00	•	•	X	•	•	•	•	•	•	•
	S088120120	88.00	120.00	12.00	X	•	•	•	•	•	•	•	•	•
	S088120130	88.00	120.00	13.00	•	•	X	X	•	•	•	•	•	•
	S088126120	88.00	126.00	12.00	X	X	•	•	•	•	•	•	•	•
	S088128120	88.00	128.00	12.00	X	•	•	•	•	•	•	•	•	•
	S089140120	88.00	140.00	12.00	X	•	•	•	•	•	•	•	•	•
	S089140130	88.00	140.00	13.00	X	•	•	•	•	•	•	•	•	•
	S089110130	89.00	110.00	13.00	•	•	X	•	•	•	•	•	•	•
	S089114140	89.00	114.00	14.00	•	•	•	X	•	•	•	•	•	•
	S089115130	89.00	115.00	13.00	•	•	•	X	•	•	•	•	•	•
	S089120130	89.00	120.00	13.00	•	•	X	•	•	•	•	•	•	•
	S090105060	90.00	105.00	6.00	•	•	•	•	•	•	•	X	•	•
	S090105130	90.00	105.00	13.00	X	•	•	•	•	•	•	•	•	•
	S090110070	90.00	110.00	7.00	•	•	•	•	•	•	•	X	•	•
	S090110080	90.00	110.00	8.00	X	X	X	•	•	•	•	•	•	•
	S090110100	90.00	110.00	10.00	X	X	X	X	•	•	•	•	•	•
	S090110120	90.00	110.00	12.00	X	X	X	X	•	•	•	•	•	•
	S090110130	90.00	110.00	13.00	X	X	X	X	X	X	•	•	•	•
	S090110140	90.00	110.00	14.00	•	•	•	X	•	•	•	•	•	•
	S090110150	90.00	110.00	15.00	X	•	X	X	•	•	•	•	•	•
	S090115050	90.00	115.00	5.00	•	•	•	•	•	•	•	X	•	•
	S090115080	90.00	115.00	8.00	X	•	•	•	•	•	•	•	•	•
	S090115090	90.00	115.00	9.00	X	X	X	X	•	•	•	•	•	•
	S090115100	90.00	115.00	10.00	X	•	•	X	•	•	•	•	•	•
	S090115120	90.00	115.00	12.00	•	•	•	X	•	•	•	•	•	•
	S090115130	90.00	115.00	13.00	X	X	X	X	X	X	•	X	•	•
	S090115150	90.00	115.00	15.00	•	•	•	X	•	•	•	•	•	•
	S090118120	90.00	118.00	12.00	•	•	•	X	X	X	•	•	•	•
	S090118150	90.00	118.00	15.00	•	•	•	X	•	•	•	•	•	•
	S090120080	90.00	120.00	8.00	•	•	•	•	•	•	•	X	•	•
	S090120100	90.00	120.00	10.00	X	X	•	•	•	•	•	•	•	•
	S090120120	90.00	120.00	12.00	X	X	X	X	X	•	•	•	•	•
	S090120130	90.00	120.00	13.00	X	X	X	X	X	X	•	•	•	•
	S090120140	90.00	120.00	14.00	X	•	•	•	•	•	•	•	•	•
S090120150	90.00	120.00	15.00	X	•	X	X	•	X	•	•	•	•	

X: EXISTING TOOLING    •: ON REQUEST

N.B.: MINIMUM LINE ORDER MAY APPLY

Tel.: (418) 688-3202  
Fax: (418) 688-4272

**SS 205**

[www.sealsonline.com](http://www.sealsonline.com)



**M**

## RADIAL SHAFT SEALS - NBR/STEEL

## GLOBAL AVAILABILITY LIST

Ref. Number	Dimensions			DESIGN TYPE										SC 
	d	D	H	SC	SB2	SA2	TC	TB2	TA2	VB	VC	KB	KC	
S090125130	90.00	125.00	13.00	X	X	X	X	.	.	.	.	.	.	
S090125140	90.00	125.00	14.00	X	.	.	.	.	.	.	.	.	.	
S090125170	90.00	125.00	17.00	.	.	.	.	X	.	.	.	.	.	
S090130030	90.00	130.00	3.00	X	.	.	.	.	.	.	.	.	.	
S090130120	90.00	130.00	12.00	X	.	.	X	.	.	.	.	.	.	
S090130130	90.00	130.00	13.00	X	.	X	X	.	X	.	.	.	.	
S090135130	90.00	135.00	13.00	.	.	.	X	.	.	.	.	.	.	
S090135150	90.00	135.00	15.00	.	.	.	.	.	X	.	.	.	.	
S090140130	90.00	140.00	13.00	X	.	X	.	.	.	.	.	.	.	
S090160120	90.00	160.00	12.00	X	.	.	.	.	.	.	.	.	.	
S090167140	90.00	167.00	14.00	X	.	.	.	.	.	.	.	.	.	
S091136120	91.00	136.00	12.00	X	.	.	.	.	.	.	.	.	.	
S092105100	92.00	105.00	10.00	.	.	.	X	.	.	.	.	.	.	
S092110120	92.00	110.00	12.00	X	.	.	.	.	.	.	.	.	.	
S092120100	92.00	120.00	10.00	.	.	.	.	.	X	.	.	.	.	
S092120120	92.00	120.00	12.00	X	.	.	X	.	.	.	.	.	.	
S092120130	92.00	120.00	13.00	X	.	X	.	.	.	.	.	.	.	
S092120140	92.00	120.00	14.00	X	.	.	.	.	.	.	.	.	.	
S092145180	92.00	145.00	18.00	.	.	.	X	.	.	.	.	.	.	
S093110130	93.00	110.00	13.00	.	.	X	.	.	.	.	.	.	.	
S094110108	94.00	110.00	10.80	.	.	.	X	.	.	.	.	.	.	
S094120130	94.00	120.00	13.00	.	.	X	.	.	.	.	.	.	.	
S095110090	95.00	110.00	9.00	X	X	X	.	.	.	.	.	.	.	
S095110100	95.00	110.00	10.00	X	X	X	X	.	.	.	.	.	.	
S095110120	95.00	110.00	12.00	X	X	X	X	.	.	.	.	.	.	
S095110130	95.00	110.00	13.00	X	X	X	X	.	.	.	.	.	.	
S095112120	95.00	112.00	12.00	.	.	.	X	.	.	.	.	.	.	
S095115080	95.00	115.00	8.00	X	.	.	.	.	.	.	.	.	.	
S095115090	95.00	115.00	9.00	.	.	X	.	.	.	.	.	.	.	
S095115100	95.00	115.00	10.00	.	.	X	.	.	.	.	.	.	.	
S095115110	95.00	115.00	11.00	X	.	.	.	.	.	.	.	.	.	
S095115120	95.00	115.00	12.00	.	.	.	X	.	.	.	.	.	.	
S095115130	95.00	115.00	13.00	X	X	X	X	.	.	.	.	.	.	
S095120080	95.00	120.00	8.00	.	.	.	.	.	.	.	X	.	.	
S095120100	95.00	120.00	10.00	.	.	.	X	.	.	.	.	.	.	
S095120120	95.00	120.00	12.00	X	X	X	X	.	.	.	.	.	.	
S095120130	95.00	120.00	13.00	X	X	X	X	X	X	.	.	.	.	
S095120140	95.00	120.00	14.00	.	.	.	.	X	.	.	.	.	.	
S095120150	95.00	120.00	15.00	.	.	X	.	.	.	.	.	.	.	
S095125100	95.00	125.00	10.00	.	.	.	X	.	.	.	.	.	.	
S095125120	95.00	125.00	12.00	X	X	.	X	.	X	.	.	.	.	
S095125130	95.00	125.00	13.00	X	X	X	.	.	.	.	.	.	.	
S095125150	95.00	125.00	15.00	.	.	X	X	.	.	.	.	.	.	
S095125160	95.00	125.00	16.00	X	.	.	.	.	.	.	.	.	.	
S095125200	95.00	125.00	20.00	.	.	.	X	.	.	.	.	.	.	
S095127120	95.00	127.00	12.00	X	.	.	.	.	.	.	.	.	.	
S095130120	95.00	130.00	12.00	X	.	.	X	.	.	.	.	.	.	
S095130130	95.00	130.00	13.00	X	X	X	X	X	.	.	.	.	.	

X: EXISTING TOOLING    .: ON REQUEST

N.B.: MINIMUM LINE ORDER MAY APPLY



## GLOBAL AVAILABILITY LIST

## RADIAL SHAFT SEALS - NBR/STEEL

METRIC SIZE  
SHAFT SEALS

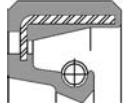
SC 	Ref. Number	Dimensions			DESIGN TYPE									
		d	D	H	SC	SB2	SA2	TC	TB2	TA2	VB	VC	KB	KC
	S095130150	95.00	130.00	15.00	X	•	•	X	X	•	•	•	•	•
	S095132120	95.00	132.00	12.00	X	•	•	•	•	•	•	•	•	•
	S095133140	95.00	133.00	14.00	•	•	X	•	•	•	•	•	•	•
	S095135130	95.00	135.00	13.00	X	•	•	X	•	•	•	X	•	•
	S095135140	95.00	135.00	14.00	•	•	•	X	•	•	•	•	•	•
	S095135200	95.00	135.00	20.00	•	•	•	X	•	•	•	•	•	•
	S095136130	95.00	136.00	13.00	X	•	•	•	•	•	•	•	•	•
	S095140130	95.00	140.00	13.00	•	•	•	X	•	•	•	•	•	•
	S095145130	95.00	145.00	13.00	X	•	•	X	•	•	•	•	•	•
	S095150150	95.00	150.00	15.00	X	•	•	•	•	•	•	•	•	•
	S095160150	95.00	160.00	15.00	X	•	•	•	•	•	•	•	•	•
	S096112100	96.00	112.00	10.00	X	•	•	•	•	•	•	•	•	•
	S096125130	96.00	125.00	13.00	•	•	X	•	•	•	•	•	•	•
	S096136120	96.00	136.00	12.00	X	•	•	•	•	•	•	•	•	•
	S097120130	97.00	120.00	13.00	•	•	X	•	•	•	•	•	•	•
	S097123140	97.00	123.00	14.00	•	•	•	X	•	•	•	•	•	•
	S097127130	97.00	127.00	13.00	X	•	•	•	•	•	•	•	•	•
	S097130140	97.00	130.00	14.00	X	•	•	•	•	•	•	•	•	•
	S097167130	97.00	167.00	13.00	X	•	•	•	•	•	•	•	•	•
	S098120120	98.00	120.00	12.00	•	•	X	•	•	•	•	•	•	•
	S098120130	98.00	120.00	13.00	X	X	X	•	X	•	•	•	•	•
	S098125100	98.00	125.00	10.00	X	•	•	•	•	•	•	•	•	•
	S098125120	98.00	125.00	12.00	X	•	•	X	•	•	•	•	•	•
	S098125130	98.00	125.00	13.00	X	•	X	•	•	•	•	•	•	•
	S098128100	98.00	128.00	10.00	X	•	X	•	•	•	•	•	•	•
	S098130130	98.00	130.00	13.00	•	X	X	•	•	X	•	•	•	•
	S100110050	100.00	110.00	5.00	•	•	•	•	•	•	•	X	•	•
	S100114070	100.00	114.00	7.00	•	X	•	•	•	•	•	•	•	•
	S100114100	100.00	114.00	10.00	•	X	•	•	•	•	•	•	•	•
	S100115090	100.00	115.00	9.00	X	X	•	•	•	•	•	•	•	•
	S100115150	100.00	115.00	15.00	•	•	•	•	•	•	•	X	•	•
	S100116120	100.00	116.00	12.00	•	•	•	X	•	•	•	•	•	•
	S100118120	100.00	118.00	12.00	•	X	•	X	•	•	•	•	•	•
	S100120055	100.00	120.00	5.50	•	•	X	•	X	•	•	•	•	•
	S100120080	100.00	120.00	8.00	•	X	•	•	•	•	•	•	•	•
	S100120100	100.00	120.00	10.00	X	X	X	X	•	X	•	•	•	•
	S100120110	100.00	120.00	11.00	X	•	•	•	X	•	•	•	•	•
	S100120120	100.00	120.00	12.00	X	X	X	X	X	•	•	•	•	•
	S100120130	100.00	120.00	13.00	X	X	X	X	X	•	•	•	•	•
	S100120150	100.00	120.00	15.00	•	X	X	•	•	•	•	•	•	•
	S100120170	100.00	120.00	17.00	•	•	•	X	•	•	•	•	•	•
	S100125080	100.00	125.00	8.00	•	•	•	X	•	•	•	•	•	•
	S100125100	100.00	125.00	10.00	X	•	•	X	•	•	•	•	•	•
	S100125110	100.00	125.00	11.00	•	•	•	•	X	•	•	•	•	•
	S100125120	100.00	125.00	12.00	X	X	•	X	•	•	•	•	•	•
	S100125130	100.00	125.00	13.00	X	X	X	X	X	X	•	•	•	•
	S100125150	100.00	125.00	15.00	X	•	X	•	•	•	•	•	•	•
	S100127100	100.00	127.00	10.00	•	•	•	X	•	•	•	•	•	•

X: EXISTING TOOLING    •: ON REQUEST

N.B.: MINIMUM LINE ORDER MAY APPLY

Tel.: (514) 334-2220  
Fax: (514) 333-8329

**SS 207**

[www.sealsonline.com](http://www.sealsonline.com)



**M**



## RADIAL SHAFT SEALS - NBR/STEEL

## GLOBAL AVAILABILITY LIST

Ref. Number	Dimensions			DESIGN TYPE									SC
	d	D	H	SC	SB2	SA2	TC	TB2	TA2	VB	VC	KB	
S100127130	100.00	127.00	13.00	X	•	•	•	•	•	•	•	•	•
S100130100	100.00	130.00	10.00	X	•	•	•	•	•	•	•	•	•
S100130120	100.00	130.00	12.00	X	X	•	X	•	•	•	•	•	•
S100130130	100.00	130.00	13.00	X	X	X	X	X	X	•	•	•	•
S100130140	100.00	130.00	14.00	X	•	•	X	•	•	•	•	•	•
S100130150	100.00	130.00	15.00	•	•	X	•	X	X	•	•	•	•
S100135100	100.00	135.00	10.00	•	•	•	X	•	•	•	•	•	•
S100135120	100.00	135.00	12.00	X	•	•	X	•	•	•	•	•	•
S100135130	100.00	135.00	13.00	X	•	X	X	•	•	•	•	•	•
S100135140	100.00	135.00	14.00	•	•	X	X	•	•	•	•	•	•
S100135150	100.00	135.00	15.00	•	•	•	X	•	•	•	•	•	•
S100137110	100.00	137.00	11.00	•	•	•	X	•	•	•	•	•	•
S100139190	100.00	139.00	19.00	•	•	•	X	•	•	•	•	•	•
S100140120	100.00	140.00	12.00	X	•	•	X	•	•	•	•	•	•
S100140130	100.00	140.00	13.00	X	•	X	X	•	•	•	•	•	•
S100150120	100.00	150.00	12.00	X	X	•	•	•	•	•	•	•	•
S100150130	100.00	150.00	13.00	X	X	X	X	•	•	•	•	•	•
S100150150	100.00	150.00	15.00	X	•	•	•	•	•	•	•	•	•
S100160120	100.00	160.00	12.00	X	•	•	•	•	•	•	•	•	•
S100160150	100.00	160.00	15.00	•	•	X	•	•	•	•	•	•	•
S100162120	100.00	162.00	12.00	•	•	•	X	•	•	•	•	•	•
S100180120	100.00	180.00	12.00	X	•	•	X	•	•	•	•	•	•
S100180130	100.00	180.00	13.00	X	•	•	•	•	•	•	•	•	•
S100185130	100.00	185.00	13.00	X	•	•	•	•	•	•	•	•	•
S101114100	101.00	114.00	10.00	•	•	•	X	•	•	•	•	•	•
S102115100	102.00	115.00	10.00	•	•	•	X	•	•	•	•	•	•
S102116140	102.00	116.00	14.00	•	•	•	•	X	•	•	•	•	•
S102122070	102.00	122.00	7.00	•	•	•	•	•	•	X	•	•	•
S102125130	102.00	125.00	13.00	•	•	X	•	•	•	•	•	•	•
S102130130	102.00	130.00	13.00	•	•	X	•	•	•	•	•	•	•
S102135130	102.00	135.00	13.00	X	•	•	•	•	•	•	•	•	•
S103125130	103.00	125.00	13.00	•	•	X	•	•	•	•	•	•	•
S104125100	104.00	125.00	10.00	X	•	•	•	•	•	•	•	•	•
S104130100	104.00	130.00	10.00	X	•	•	•	•	•	•	•	•	•
S104130130	104.00	130.00	13.00	•	•	X	•	•	•	•	•	•	•
S105120070	105.00	120.00	7.00	•	X	•	•	•	•	•	•	•	•
S105120080	105.00	120.00	8.00	•	•	•	X	•	•	•	•	•	•
S105120100	105.00	120.00	10.00	X	•	•	•	•	•	•	•	•	•
S105120150	105.00	120.00	15.00	•	•	X	•	•	•	•	•	•	•
S105125100	105.00	125.00	10.00	X	X	•	•	•	•	•	•	•	•
S105125117	105.00	125.00	11.70	•	•	•	X	•	•	•	•	•	•
S105125120	105.00	125.00	12.00	•	X	•	•	•	•	•	•	•	•
S105125130	105.00	125.00	13.00	X	X	X	X	•	•	•	•	•	•
S105127100	105.00	127.00	10.00	•	•	•	X	•	•	•	•	•	•
S105130120	105.00	130.00	12.00	X	X	X	X	•	•	•	•	•	•
S105130130	105.00	130.00	13.00	X	X	X	X	X	•	•	•	•	•
S105130150	105.00	130.00	15.00	X	•	X	X	•	•	•	•	•	•
S105135130	105.00	135.00	13.00	X	•	•	X	•	•	•	•	•	•

X: EXISTING TOOLING •: ON REQUEST



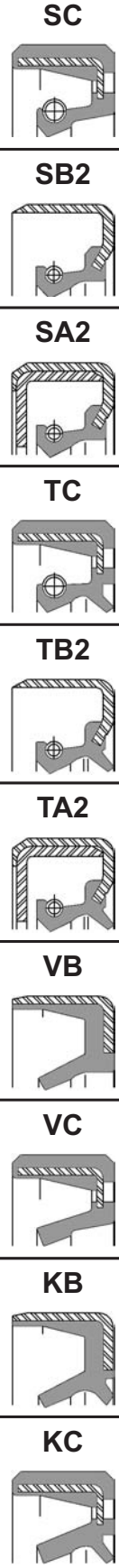







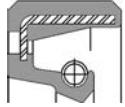





N.B.: MINIMUM LINE ORDER MAY APPLY



## GLOBAL AVAILABILITY LIST

## RADIAL SHAFT SEALS - NBR/STEEL

METRIC SIZE  
SHAFT SEALS

SC 	Ref. Number	Dimensions			DESIGN TYPE									
		d	D	H	SC	SB2	SA2	TC	TB2	TA2	VB	VC	KB	KC
	S105135140	105.00	135.00	14.00	X	X	•	X	X	•	•	•	•	•
	S105135150	105.00	135.00	15.00	•	•	•	X	•	•	•	•	•	•
	S105136130	105.00	136.00	13.00	•	•	•	X	•	•	•	•	•	•
	S105140120	105.00	140.00	12.00	X	X	•	X	•	•	•	•	•	•
	S105140130	105.00	140.00	13.00	X	X	X	X	•	X	•	•	•	•
	S105140150	105.00	140.00	15.00	•	•	X	X	•	•	•	•	•	•
	S105140160	105.00	140.00	16.00	X	•	•	•	•	•	•	•	•	•
	S105145130	105.00	145.00	13.00	•	X	•	•	•	•	•	•	•	•
	S105145150	105.00	145.00	15.00	•	X	•	X	•	•	•	•	•	•
	S105145160	105.00	145.00	16.00	X	•	•	•	•	•	•	•	•	•
	S105150150	105.00	150.00	15.00	X	•	X	•	•	•	•	•	•	•
	S106126130	106.00	126.00	13.00	•	•	•	X	•	•	•	•	•	•
	S106130130	106.00	130.00	13.00	•	•	X	•	•	•	•	•	•	•
	S107130130	107.00	130.00	13.00	•	•	X	•	•	•	•	•	•	•
	S107140130	107.00	140.00	13.00	•	•	X	•	•	•	•	•	•	•
	S107150150	107.00	150.00	15.00	X	•	•	•	•	•	•	•	•	•
	S108130120	108.00	130.00	12.00	X	•	•	•	•	•	•	•	•	•
	S108130130	108.00	130.00	13.00	X	•	X	•	•	•	•	•	•	•
	S108140130	108.00	140.00	13.00	•	•	X	•	•	•	•	•	•	•
	S108145150	108.00	145.00	15.00	X	•	•	•	•	•	•	•	•	•
	S110125095	110.00	125.00	9.50	•	•	•	X	•	•	•	•	•	•
	S110125120	110.00	125.00	12.00	X	•	•	•	•	•	•	•	•	•
	S110125130	110.00	125.00	13.00	X	•	•	•	•	•	•	•	•	•
	S110126380	110.00	126.00	38.00	•	•	•	X	•	•	•	•	•	•
	S110128090	110.00	128.00	9.00	•	X	X	•	•	•	•	•	•	•
	S110130080	110.00	130.00	8.00	X	•	•	•	•	•	•	•	•	•
	S110130100	110.00	130.00	10.00	X	•	•	X	•	•	•	•	•	•
	S110130120	110.00	130.00	12.00	X	X	X	2	•	•	•	•	•	•
	S110130130	110.00	130.00	13.00	X	X	X	X	X	•	•	•	•	•
	S110130140	110.00	130.00	14.00	X	•	•	•	•	•	•	•	•	•
	S110130145	110.00	130.00	14.50	X	•	•	•	•	•	•	•	•	•
	S110130150	110.00	130.00	15.00	•	X	X	X	•	•	•	•	•	•
	S110130180	110.00	130.00	18.00	•	•	•	X	•	•	•	•	•	•
	S110132120	110.00	132.00	12.00	•	X	•	•	•	•	•	•	•	•
	S110135120	110.00	135.00	12.00	X	X	•	X	•	•	•	•	•	•
	S110135130	110.00	135.00	13.00	X	•	X	X	•	X	•	•	•	•
	S110135140	110.00	135.00	14.00	•	•	•	X	•	•	•	•	•	•
	S110135150	110.00	135.00	15.00	•	•	•	X	•	•	•	•	•	•
	S110140100	110.00	140.00	10.00	X	•	•	•	•	•	•	•	•	•
	S110140120	110.00	140.00	12.00	X	X	X	X	•	•	•	•	•	•
	S110140130	110.00	140.00	13.00	X	X	X	X	X	X	•	•	•	•
	S110140140	110.00	140.00	14.00	X	•	•	X	•	•	•	•	•	•
	S110140150	110.00	140.00	15.00	•	•	X	X	•	•	•	•	•	•
	S110140155	110.00	140.00	15.50	•	•	X	•	•	•	•	•	•	•
	S110142120	110.00	142.00	12.00	•	X	•	•	•	•	•	•	•	•
	S110145130	110.00	145.00	13.00	X	•	X	•	•	•	•	•	•	•
	S110145140	110.00	145.00	14.00	X	•	•	X	•	•	•	•	•	•
	S110145150	110.00	145.00	15.00	X	X	•	X	•	•	•	•	•	•

X: EXISTING TOOLING    •: ON REQUEST

N.B.: MINIMUM LINE ORDER MAY APPLY

Tel.: (888) 238-5885  
Fax: (888) 238-1664

**SS 209**

[www.sealsonline.com](http://www.sealsonline.com)



**M**

## RADIAL SHAFT SEALS - NBR/STEEL

## GLOBAL AVAILABILITY LIST

Ref. Number	Dimensions			DESIGN TYPE									SC
	d	D	H	SC	SB2	SA2	TC	TB2	TA2	VB	VC	KB	
S110148150	110.00	148.00	15.00	•	•	•	X	•	•	•	•	•	•
S110150130	110.00	150.00	13.00	X	•	X	X	X	•	•	•	•	•
S110150150	110.00	150.00	15.00	X	•	X	•	•	•	•	•	•	•
S110150180	110.00	150.00	18.00	•	•	•	•	•	•	•	•	•	•
S110152150	110.00	152.00	15.00	•	•	X	•	•	•	•	•	•	•
S110155150	110.00	155.00	15.00	X	•	•	•	•	•	•	•	•	•
S110159140	110.00	159.00	14.00	X	•	•	•	•	•	•	•	•	•
S110160100	110.00	160.00	10.00	X	•	•	•	•	•	•	•	•	•
S110160130	110.00	160.00	13.00	•	•	•	X	•	•	•	•	•	•
S110160150	110.00	160.00	15.00	X	•	•	•	•	•	•	•	•	•
S110170120	110.00	170.00	12.00	•	•	•	X	•	•	•	•	•	•
S110200130	110.00	200.00	13.00	•	•	•	X	•	•	•	•	•	•
S112125090	112.00	125.00	9.00	X	•	•	•	•	•	•	•	•	•
S112130080	112.00	130.00	8.00	•	X	•	•	•	•	•	•	•	•
S112130120	112.00	130.00	12.00	•	X	•	•	•	•	•	•	•	•
S112140130	112.00	140.00	13.00	X	•	X	•	X	•	•	•	•	•
S112142120	112.00	142.00	12.00	•	•	•	X	•	•	•	•	•	•
S112150150	112.00	150.00	15.00	•	•	X	•	•	•	•	•	•	•
S112200100	112.00	200.00	10.00	•	•	X	•	•	•	•	•	•	•
S113140130	113.00	140.00	13.00	•	•	X	•	•	•	•	•	•	•
S114127090	114.00	127.00	9.00	X	•	•	•	•	•	•	•	•	•
S114140130	114.00	140.00	13.00	X	•	X	•	•	•	•	•	•	•
S115130120	115.00	130.00	12.00	X	•	•	•	•	•	•	•	•	•
S115130130	115.00	130.00	13.00	X	X	•	•	•	•	•	•	•	•
S115135130	115.00	135.00	13.00	•	X	•	•	•	•	•	•	•	•
S115135140	115.00	135.00	14.00	•	•	•	X	•	•	•	•	•	•
S115140100	115.00	140.00	10.00	X	•	•	•	•	•	•	•	•	•
S115140110	115.00	140.00	11.00	•	•	•	•	•	X	•	•	•	•
S115140120	115.00	140.00	12.00	X	X	X	X	•	•	•	•	•	•
S115140130	115.00	140.00	13.00	X	X	X	X	X	X	•	•	•	•
S115140150	115.00	140.00	15.00	•	X	X	•	X	•	•	•	•	•
S115140160	115.00	140.00	16.00	•	•	•	•	X	•	•	•	•	•
S115145130	115.00	145.00	13.00	X	•	•	•	•	•	•	•	•	•
S115145140	115.00	145.00	14.00	X	•	•	X	•	•	•	•	•	•
S115145150	115.00	145.00	15.00	X	•	•	•	•	•	•	•	•	•
S115145160	115.00	145.00	16.00	•	•	•	•	•	X	•	•	•	•
S115145180	115.00	145.00	18.00	•	•	•	•	•	•	•	•	•	•
S115150120	115.00	150.00	12.00	X	•	•	X	•	•	•	•	•	•
S115150130	115.00	150.00	13.00	X	•	X	X	X	X	•	•	•	•
S115150150	115.00	150.00	15.00	•	•	X	X	X	X	•	•	•	•
S115150160	115.00	150.00	16.00	•	•	X	•	•	•	•	•	•	•
S115151100	115.00	151.00	10.00	•	•	•	X	•	•	•	•	•	•
S115160150	115.00	160.00	15.00	X	•	X	•	•	•	•	•	•	•
S115165150	115.00	165.00	15.00	•	•	•	X	•	•	•	•	•	•
S115190150	115.00	190.00	15.00	X	X	•	•	•	•	•	•	•	•
S116132120	116.00	132.00	12.00	•	•	•	X	X	•	•	•	•	•
S116140130	116.00	140.00	13.00	•	•	X	•	•	•	•	•	•	•
S118136130	118.00	136.00	13.00	•	X	•	•	•	•	•	•	•	•

X: EXISTING TOOLING •: ON REQUEST

N.B.: MINIMUM LINE ORDER MAY APPLY

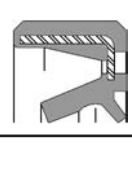
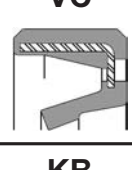
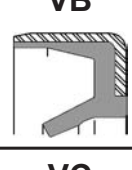
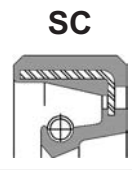

## GLOBAL AVAILABILITY LIST

## RADIAL SHAFT SEALS - NBR/STEEL

METRIC SIZE  
SHAFT SEALS

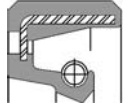
SC 	Ref. Number	Dimensions			DESIGN TYPE									
		d	D	H	SC	SB2	SA2	TC	TB2	TA2	VB	VC	KB	KC
	S118140130	118.00	140.00	13.00	X	•	X	X	•	•	•	•	•	•
	S118140160	118.00	140.00	16.00	•	•	•	•	•	•	•	•	•	•
	S118150120	118.00	150.00	12.00	•	•	•	•	•	X	•	•	•	•
	S118150150	118.00	150.00	15.00	•	•	X	•	•	•	•	•	•	•
	S118160150	118.00	160.00	15.00	•	•	X	•	•	•	•	•	•	•
	S119150150	119.00	150.00	15.00	•	•	X	•	•	•	•	•	•	•
	S120140100	120.00	140.00	10.00	X	•	X	•	•	•	•	•	•	•
	S120140105	120.00	140.00	10.50	•	•	•	•	X	•	•	•	•	•
	S120140120	120.00	140.00	12.00	X	•	•	X	•	•	•	•	•	•
	S120140130	120.00	140.00	13.00	X	X	X	X	X	X	•	•	•	•
	S120140140	120.00	140.00	14.00	X	•	•	X	•	•	•	•	•	•
	S120145120	120.00	145.00	12.00	X	•	•	X	•	•	•	•	•	•
	S120145125	120.00	145.00	12.50	•	•	•	X	•	•	•	•	•	•
	S120145130	120.00	145.00	13.00	•	•	X	X	•	•	•	•	•	•
	S120145145	120.00	145.00	14.50	•	•	X	•	•	•	•	•	•	•
	S120145150	120.00	145.00	15.00	•	•	X	X	X	•	•	•	•	•
	S120145155	120.00	145.00	15.50	•	•	•	X	•	•	•	•	•	•
	S120146160	120.00	146.00	16.00	•	•	X	•	•	•	•	•	•	•
	S120150120	120.00	150.00	12.00	X	X	X	X	X	•	•	•	•	•
	S120150130	120.00	150.00	13.00	X	X	X	X	X	•	•	•	•	•
	S120150140	120.00	150.00	14.00	•	•	•	X	•	•	•	•	•	•
	S120150150	120.00	150.00	15.00	X	X	X	X	•	X	•	•	•	•
	S120150160	120.00	150.00	16.00	•	•	•	X	•	•	•	•	•	•
	S120150180	120.00	150.00	18.00	•	•	•	X	•	•	•	•	•	•
	S120152160	120.00	152.00	16.00	•	•	X	•	•	•	•	•	•	•
	S120155120	120.00	155.00	12.00	•	•	•	X	•	•	•	•	•	•
	S120155150	120.00	155.00	15.00	•	•	•	X	•	•	•	•	•	•
	S120155160	120.00	155.00	16.00	•	•	•	X	•	X	•	•	•	•
	S120160120	120.00	160.00	12.00	X	X	•	X	•	•	•	•	•	•
	S120160130	120.00	160.00	13.00	X	•	X	X	•	•	•	•	•	•
	S120160140	120.00	160.00	14.00	X	•	•	•	•	•	•	•	•	•
	S120160150	120.00	160.00	15.00	X	•	X	X	•	•	•	•	•	•
	S120170150	120.00	170.00	15.00	•	•	X	•	•	•	•	•	•	•
	S120195130	120.00	195.00	13.00	X	•	•	•	•	•	•	•	•	•
	S122150130	122.00	150.00	13.00	•	•	X	•	•	•	•	•	•	•
	S122150150	122.00	150.00	15.00	X	•	X	X	•	•	•	•	•	•
	S124150150	124.00	150.00	15.00	•	•	X	•	•	•	•	•	•	•
	S125140070	125.00	140.00	7.00	•	•	•	•	•	•	X	•	•	•
	S125140100	125.00	140.00	10.00	X	•	•	•	•	•	•	•	•	•
	S125142130	125.00	142.00	13.00	•	•	•	X	•	•	•	•	•	•
	S125143120	125.00	143.00	12.00	X	•	•	•	•	•	•	•	•	•
	S125143130	125.00	143.00	13.00	•	•	•	X	•	X	•	•	•	•
	S125145075	125.00	145.00	7.50	X	•	•	•	•	•	•	•	•	•
	S125146130	125.00	146.00	13.00	•	•	X	•	•	•	•	•	•	•
	S125150100	125.00	150.00	10.00	•	•	•	•	•	X	•	•	•	•
	S125150120	125.00	150.00	12.00	X	X	X	X	•	•	•	•	•	•
	S125150130	125.00	150.00	13.00	X	X	X	X	X	X	•	•	•	•
	S125150140	125.00	150.00	14.00	X	•	•	X	X	•	•	•	•	•

X: EXISTING TOOLING    •: ON REQUEST

N.B.: MINIMUM LINE ORDER MAY APPLY

Tel.: (204) 783-9617  
Fax: (204) 783-6091

**SS 211**

[www.sealsonline.com](http://www.sealsonline.com)



**M**

## RADIAL SHAFT SEALS - NBR/STEEL

## GLOBAL AVAILABILITY LIST

Ref. Number	Dimensions			DESIGN TYPE									SC
	d	D	H	SC	SB2	SA2	TC	TB2	TA2	VB	VC	KB	
S125150150	125.00	150.00	15.00	X	•	X	•	•	•	•	•	•	•
S125155120	125.00	155.00	12.00	X	•	•	X	•	•	•	•	•	•
S125155140	125.00	155.00	14.00	•	•	•	X	X	•	•	•	•	•
S125155150	125.00	155.00	15.00	•	•	•	X	•	•	•	•	•	•
S125160120	125.00	160.00	12.00	X	X	•	X	•	•	•	•	•	•
S125160130	125.00	160.00	13.00	X	X	X	•	•	•	•	•	•	•
S125160150	125.00	160.00	15.00	X	•	X	X	•	X	•	•	•	•
S125162120	125.00	162.00	12.00	•	•	•	•	•	X	•	•	•	•
S125162150	125.00	162.00	15.00	•	•	X	•	•	•	•	•	•	•
S125165150	125.00	165.00	15.00	•	•	•	X	•	•	•	•	•	•
S125170130	125.00	170.00	13.00	•	•	X	•	•	•	•	•	•	•
S125170150	125.00	170.00	15.00	•	•	X	•	•	•	•	•	•	•
S127150130	127.00	150.00	13.00	X	•	•	•	•	•	•	•	•	•
S127160160	127.00	160.00	16.00	•	•	•	•	•	X	•	•	•	•
S127170140	127.00	170.00	14.00	X	•	•	•	•	•	•	•	•	•
S128146135	128.00	146.00	13.50	X	•	•	X	•	•	•	•	•	•
S128148140	128.00	148.00	14.00	•	•	•	X	•	•	•	•	•	•
S128150130	128.00	150.00	13.00	X	•	•	•	•	•	•	•	•	•
S128150140	128.00	150.00	14.00	X	•	•	•	•	•	•	•	•	•
S128150150	128.00	150.00	15.00	•	X	X	•	•	•	•	•	•	•
S128158200	128.00	158.00	20.00	X	•	•	•	•	•	•	•	•	•
S128160150	128.00	160.00	15.00	•	•	X	•	•	•	•	•	•	•
S129160150	129.00	160.00	15.00	•	•	X	•	•	•	•	•	•	•
S130140100	130.00	140.00	10.00	X	•	•	•	•	•	•	•	•	•
S130150100	130.00	150.00	10.00	X	X	•	X	•	•	•	•	•	•
S130150120	130.00	150.00	12.00	•	•	•	X	•	•	•	•	•	•
S130150130	130.00	150.00	13.00	•	•	•	•	X	•	•	•	•	•
S130150140	130.00	150.00	14.00	•	•	X	•	X	•	•	•	•	•
S130150150	130.00	150.00	15.00	•	•	•	X	•	•	•	•	•	•
S130155100	130.00	155.00	10.00	•	X	X	•	•	X	•	•	•	•
S130155120	130.00	155.00	12.00	•	•	X	•	•	•	•	•	•	•
S130160120	130.00	160.00	12.00	X	X	•	X	•	•	•	•	•	•
S130160130	130.00	160.00	13.00	X	X	X	X	X	•	•	•	•	•
S130160140	130.00	160.00	14.00	X	•	•	X	X	•	•	•	•	•
S130160150	130.00	160.00	15.00	X	X	X	X	•	X	•	•	•	•
S130160160	130.00	160.00	16.00	•	X	•	•	•	•	•	•	•	•
S130162090	130.00	162.00	9.00	•	•	•	X	•	•	•	•	•	•
S130163180	130.00	163.00	18.00	•	•	•	X	•	•	•	•	•	•
S130165130	130.00	165.00	13.00	X	•	X	•	•	•	•	•	•	•
S130165150	130.00	165.00	15.00	X	•	•	•	•	•	•	•	•	•
S130170120	130.00	170.00	12.00	X	•	•	•	•	•	•	•	•	•
S130170130	130.00	170.00	13.00	X	•	X	•	X	•	•	•	•	•
S130170140	130.00	170.00	14.00	X	•	•	•	•	•	•	•	•	•
S130170150	130.00	170.00	15.00	X	X	X	•	•	X	•	•	•	•
S130170160	130.00	170.00	16.00	•	•	X	•	•	•	•	•	•	•
S130180150	130.00	180.00	15.00	X	X	X	•	•	•	•	•	•	•
S130182160	130.00	182.00	16.00	X	•	•	•	•	•	•	•	•	•
S130230140	130.00	230.00	14.00	X	•	•	X	•	•	•	•	•	•

X: EXISTING TOOLING ••: ON REQUEST

N.B.: MINIMUM LINE ORDER MAY APPLY

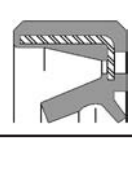
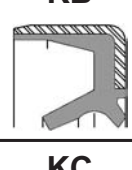
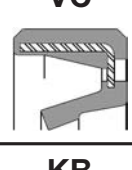
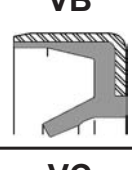
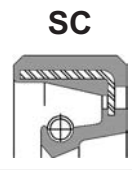

## GLOBAL AVAILABILITY LIST

## RADIAL SHAFT SEALS - NBR/STEEL

**METRIC SIZE  
SHAFT SEALS**

SC 	Ref. Number	Dimensions			DESIGN TYPE									
		d	D	H	SC	SB2	SA2	TC	TB2	TA2	VB	VC	KB	KC
	S132160130	132.00	160.00	13.00	•	•	X	•	•	X	•	•	•	•
	S132160150	132.00	160.00	15.00	•	•	X	•	•	•	•	•	•	•
	S133159060	133.00	159.00	6.00	•	•	•	•	•	•	•	X	•	•
	S133160150	133.00	160.00	15.00	•	•	•	X	•	•	•	•	•	•
	S133165160	133.00	165.00	16.00	•	•	•	•	•	X	•	•	•	•
	S135155120	135.00	155.00	12.00	X	•	•	•	•	•	•	•	•	•
	S135155130	135.00	155.00	13.00	•	•	X	•	•	•	•	•	•	•
	S135160120	135.00	160.00	12.00	X	•	•	X	•	•	•	•	•	•
	S135160130	135.00	160.00	13.00	X	X	X	X	•	•	•	•	•	•
	S135160140	135.00	160.00	14.00	X	•	•	•	•	•	•	•	•	•
	S135160150	135.00	160.00	15.00	X	X	X	X	•	•	•	•	•	•
	S135162130	135.00	162.00	13.00	•	•	•	•	X	•	•	•	•	•
	S135165120	135.00	165.00	12.00	X	•	•	X	•	•	•	•	•	•
	S135165130	135.00	165.00	13.00	•	•	X	X	•	•	•	•	•	•
	S135165140	135.00	165.00	14.00	•	•	•	X	•	•	•	X	•	•
	S135165150	135.00	165.00	15.00	X	•	X	X	•	•	•	•	•	•
	S135170120	135.00	170.00	12.00	X	X	•	X	•	•	•	•	•	•
	S135170130	135.00	170.00	13.00	•	•	X	•	•	•	•	•	•	•
	S135170140	135.00	170.00	14.00	•	•	•	X	•	•	•	•	•	•
	S135170150	135.00	170.00	15.00	X	X	X	X	•	•	•	•	•	•
	S135170180	135.00	170.00	18.00	X	•	•	•	•	•	•	•	•	•
	S135175150	135.00	175.00	15.00	•	X	•	•	•	•	•	•	•	•
	S135180150	135.00	180.00	15.00	X	•	X	•	•	•	•	•	•	•
	S135190140	135.00	190.00	14.00	X	•	•	•	•	•	•	•	•	•
	S135190150	135.00	190.00	15.00	X	•	•	•	•	•	•	•	•	•
	S135192160	135.00	192.00	16.00	X	•	•	•	•	•	•	•	•	•
	S138160150	138.00	160.00	15.00	X	•	X	•	•	•	•	•	•	•
	S138165120	138.00	165.00	12.00	X	•	•	•	•	•	•	•	•	•
	S138170150	138.00	170.00	15.00	•	•	X	•	•	•	•	•	•	•
	S140070120	140.00	70.00	12.00	X	•	•	•	•	•	•	•	•	•
	S140160100	140.00	160.00	10.00	X	•	•	•	•	•	•	•	•	•
	S140160120	140.00	160.00	12.00	•	X	•	X	•	•	•	•	•	•
	S140160130	140.00	160.00	13.00	X	X	X	X	X	X	•	•	•	•
	S140160140	140.00	160.00	14.00	•	•	•	•	X	•	•	•	•	•
	S140160150	140.00	160.00	15.00	X	•	X	•	•	•	•	•	•	•
	S140162120	140.00	162.00	12.00	•	•	•	X	•	•	•	•	•	•
	S140165120	140.00	165.00	12.00	X	•	X	•	•	•	•	•	•	•
	S140165125	140.00	165.00	12.50	•	•	X	•	•	•	•	•	•	•
	S140165140	140.00	165.00	14.00	•	•	•	•	X	•	•	•	•	•
	S140165150	140.00	165.00	15.00	X	•	X	•	•	•	•	•	•	•
	S140170120	140.00	170.00	12.00	X	•	X	X	•	X	•	•	•	•
	S140170130	140.00	170.00	13.00	X	•	X	X	•	•	•	•	•	•
	S140170140	140.00	170.00	14.00	X	•	X	X	X	•	•	•	•	•
	S140170150	140.00	170.00	15.00	X	X	X	X	•	X	•	•	•	•
	S140170160	140.00	170.00	16.00	•	•	•	X	•	•	•	•	•	•
	S140170180	140.00	170.00	18.00	X	•	•	•	•	•	•	•	•	•
	S140175130	140.00	175.00	13.00	•	•	•	•	X	•	•	•	•	•
	S140175150	140.00	175.00	15.00	•	X	•	X	•	•	•	•	•	•

X: EXISTING TOOLING    •: ON REQUEST

N.B.: MINIMUM LINE ORDER MAY APPLY

**Tel.: (780) 414-1871**  
**Fax: (780) 487-5419**

**SS 213**

[www.sealsonline.com](http://www.sealsonline.com)



## RADIAL SHAFT SEALS - NBR/STEEL

## GLOBAL AVAILABILITY LIST

Ref. Number	Dimensions			DESIGN TYPE									SC
	d	D	H	SC	SB2	SA2	TC	TB2	TA2	VB	VC	KB	
S140175160	140.00	175.00	16.00	•	•	•	X	•	•	•	•	•	•
S140180120	140.00	180.00	12.00	X	•	•	X	•	•	•	•	•	•
S140180130	140.00	180.00	13.00	X	•	•	•	•	•	•	•	•	•
S140180140	140.00	180.00	14.00	X	•	•	•	•	•	•	•	•	•
S140180150	140.00	180.00	15.00	X	•	X	X	X	•	•	•	•	•
S140190150	140.00	190.00	15.00	•	•	X	•	•	•	•	•	•	•
S143167130	143.00	167.00	13.00	•	•	•	X	•	•	•	•	•	•
S143170100	143.00	170.00	10.00	•	•	X	•	•	•	•	•	•	•
S143175160	143.00	175.00	16.00	X	•	•	•	•	•	•	•	•	•
S144160120	144.00	160.00	12.00	X	•	•	X	•	•	•	•	•	•
S144160250	144.00	160.00	25.00	•	•	•	X	•	•	•	•	•	•
S144180150	144.00	180.00	15.00	•	•	X	•	•	•	•	•	•	•
S145160100	145.00	160.00	10.00	X	•	•	•	•	•	•	•	•	•
S145165130	145.00	165.00	13.00	X	•	X	•	•	•	•	•	•	•
S145165150	145.00	165.00	15.00	X	•	X	•	•	•	•	•	•	•
S145167130	145.00	167.00	13.00	•	•	•	X	•	X	•	•	•	•
S145170100	145.00	170.00	10.00	•	•	X	•	•	•	•	•	•	•
S145170120	145.00	170.00	12.00	•	•	•	X	•	•	•	•	•	•
S145170130	145.00	170.00	13.00	•	X	X	•	X	•	•	•	•	•
S145170140	145.00	170.00	14.00	•	•	•	•	X	•	•	•	•	•
S145170150	145.00	170.00	15.00	X	X	X	X	•	•	•	•	•	•
S145170180	145.00	170.00	18.00	•	•	•	•	X	•	•	•	•	•
S145175120	145.00	175.00	12.00	X	•	•	•	•	•	•	•	•	•
S145175130	145.00	175.00	13.00	•	X	X	•	X	•	•	•	•	•
S145175140	145.00	175.00	14.00	•	•	•	X	X	•	•	•	•	•
S145175150	145.00	175.00	15.00	X	X	X	X	•	•	•	•	•	•
S145180120	145.00	180.00	12.00	X	•	•	X	•	•	•	•	•	•
S145180130	145.00	180.00	13.00	X	•	X	•	•	•	•	•	•	•
S145180140	145.00	180.00	14.00	X	•	•	•	•	•	•	•	•	•
S145180150	145.00	180.00	15.00	•	•	X	•	X	X	•	•	•	•
S145185150	145.00	185.00	15.00	X	•	•	•	•	•	•	•	•	•
S145190150	145.00	190.00	15.00	•	•	X	•	•	•	•	•	•	•
S146163070	146.00	163.00	7.00	X	•	•	•	•	•	•	•	•	•
S146170150	146.00	170.00	15.00	•	•	X	•	•	•	•	•	•	•
S146170180	146.00	170.00	18.00	•	X	•	•	X	•	•	•	•	•
S146225200	146.00	225.00	20.00	•	•	•	X	•	•	•	•	•	•
S148170140	148.00	170.00	14.00	•	•	•	X	•	•	•	•	•	•
S148170145	148.00	170.00	14.50	X	•	•	•	•	X	•	•	•	•
S148170150	148.00	170.00	15.00	X	•	X	X	•	•	•	•	•	•
S148170180	148.00	170.00	18.00	•	•	•	X	•	•	•	•	•	•
S148180150	148.00	180.00	15.00	•	•	X	•	•	•	•	•	•	•
S148190150	148.00	190.00	15.00	•	•	X	•	•	•	•	•	•	•
S149170145	149.00	170.00	14.50	•	•	•	•	•	X	•	•	•	•
S149180150	149.00	180.00	15.00	•	•	X	•	•	•	•	•	•	•
S150162090	150.00	162.00	9.00	X	•	•	•	•	•	•	•	•	•
S150164160	150.00	164.00	16.00	X	•	•	•	•	•	•	•	•	•
S150168120	150.00	168.00	12.00	X	•	•	•	•	•	•	•	•	•
S150168130	150.00	168.00	13.00	X	X	•	X	•	•	•	•	•	•

X: EXISTING TOOLING •: ON REQUEST



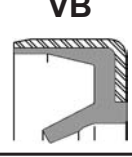
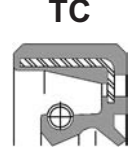
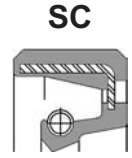





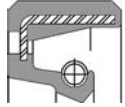

N.B.: MINIMUM LINE ORDER MAY APPLY



## GLOBAL AVAILABILITY LIST

## RADIAL SHAFT SEALS - NBR/STEEL

METRIC SIZE  
SHAFT SEALS

SC 	Ref. Number	Dimensions			DESIGN TYPE									
		d	D	H	SC	SB2	SA2	TC	TB2	TA2	VB	VC	KB	KC
	S150170120	150.00	170.00	12.00	X	•	•	•	•	•	•	•	•	•
	S150170130	150.00	170.00	13.00	X	•	•	•	•	•	•	•	•	•
	S150170150	150.00	170.00	15.00	X	•	X	X	X	X	•	•	•	•
SB2 	S150178120	150.00	178.00	12.00	•	•	•	X	•	•	•	•	•	•
	S150180120	150.00	180.00	12.00	X	•	X	•	•	•	•	•	•	•
	S150180130	150.00	180.00	13.00	X	X	X	X	•	X	•	•	•	•
	S150180140	150.00	180.00	14.00	X	X	•	X	•	•	•	X	•	•
	S150180150	150.00	180.00	15.00	X	X	X	X	X	X	•	•	•	•
SA2 	S150180180	150.00	180.00	18.00	•	•	•	X	•	•	•	•	•	•
	S150190130	150.00	190.00	13.00	•	•	•	•	X	•	•	•	•	•
	S150190150	150.00	190.00	15.00	•	•	X	X	X	•	•	•	•	•
	S150190160	150.00	190.00	16.00	•	X	•	•	•	•	•	•	•	•
	S150195150	150.00	195.00	15.00	•	•	X	•	•	•	•	•	•	•
TC 	S150200150	150.00	200.00	15.00	X	•	X	•	•	•	•	•	•	•
	S152190150	152.00	190.00	15.00	•	•	X	•	•	•	•	•	•	•
	S152195150	152.00	195.00	15.00	•	•	X	•	•	•	•	•	•	•
	S154180180	154.00	180.00	18.00	•	•	•	X	•	•	•	•	•	•
	S155172140	155.00	172.00	14.00	•	•	•	•	X	•	•	•	•	•
TB2 	S155174120	155.00	174.00	12.00	X	•	•	•	•	•	•	•	•	•
	S155175120	155.00	175.00	12.00	X	•	•	•	•	•	•	•	•	•
	S155175130	155.00	175.00	13.00	•	•	•	X	•	•	•	•	•	•
	S155180120	155.00	180.00	12.00	•	•	X	•	•	•	•	•	•	•
	S155180140	155.00	180.00	14.00	X	•	•	•	X	•	•	•	•	•
TA2 	S155180150	155.00	180.00	15.00	X	•	X	X	X	•	•	•	•	•
	S155180170	155.00	180.00	17.00	•	•	•	•	X	•	•	•	•	•
	S155185140	155.00	185.00	14.00	•	•	•	•	X	•	•	•	•	•
	S155185150	155.00	185.00	15.00	•	•	•	X	•	•	•	•	•	•
	S155190130	155.00	190.00	13.00	X	•	•	•	•	•	•	•	•	•
VB 	S155190150	155.00	190.00	15.00	X	X	X	X	•	•	•	•	•	•
	S155190170	155.00	190.00	17.00	•	•	•	•	X	•	•	•	•	•
	S155200150	155.00	200.00	15.00	X	•	X	X	•	•	•	•	•	•
	S155210250	155.00	210.00	25.00	•	•	•	X	•	•	•	•	•	•
	S156196200	156.00	196.00	20.00	X	•	•	•	•	•	•	•	•	•
VC 	S157181115	157.00	181.00	11.50	•	•	X	•	•	•	•	•	•	•
	S158180150	158.00	180.00	15.00	X	•	X	•	•	•	•	•	•	•
	S158190150	158.00	190.00	15.00	X	•	•	•	•	•	•	•	•	•
	S159185160	159.00	185.00	16.00	•	•	X	•	•	•	•	•	•	•
	S160180100	160.00	180.00	10.00	X	X	•	X	•	•	•	•	•	•
KB 	S160180120	160.00	180.00	12.00	X	•	•	•	•	•	•	•	•	•
	S160180130	160.00	180.00	13.00	•	•	•	X	•	•	•	•	•	•
	S160180150	160.00	180.00	15.00	X	•	X	•	X	X	•	•	•	•
	S160185100	160.00	185.00	10.00	X	X	X	X	•	•	•	•	•	•
	S160185130	160.00	185.00	13.00	•	•	•	X	X	•	•	•	•	•
KC 	S160185150	160.00	185.00	15.00	X	•	•	•	•	•	•	•	•	•
	S160190130	160.00	190.00	13.00	X	X	X	X	X	•	•	•	•	•
	S160190140	160.00	190.00	14.00	X	•	•	•	•	•	•	•	•	•
	S160190150	160.00	190.00	15.00	X	X	X	X	•	X	•	•	•	•
	S160192120	160.00	192.00	12.00	•	•	•	X	•	•	•	•	•	•

X: EXISTING TOOLING    •: ON REQUEST

N.B.: MINIMUM LINE ORDER MAY APPLY

Tel.: (604) 278-6808  
Fax: (604) 278-6180

**SS 215**

[www.sealsonline.com](http://www.sealsonline.com)



**M**



## RADIAL SHAFT SEALS - NBR/STEEL

## GLOBAL AVAILABILITY LIST

Ref. Number	Dimensions			DESIGN TYPE									SC
	d	D	H	SC	SB2	SA2	TC	TB2	TA2	VB	VC	KB	
S160195150	160.00	195.00	15.00	•	•	•	X	•	•	•	•	•	•
S160195180	160.00	195.00	18.00	X	•	•	•	•	•	•	•	•	•
S160200120	160.00	200.00	12.00	X	•	•	X	•	•	•	•	•	•
S160200140	160.00	200.00	14.00	X	•	X	•	X	•	•	•	•	•
S160200150	160.00	200.00	15.00	X	X	X	X	•	•	•	•	•	•
S160210200	160.00	210.00	20.00	•	•	•	X	•	•	•	•	•	•
S161215150	161.00	215.00	15.00	X	•	•	•	•	•	•	•	•	•
S162190100	162.00	190.00	10.00	•	•	X	•	•	•	•	•	•	•
S162190120	162.00	190.00	12.00	X	•	•	•	•	•	•	•	•	•
S162190150	162.00	190.00	15.00	•	•	X	•	•	•	•	•	•	•
S165190080	165.00	190.00	8.00	•	•	•	X	•	•	•	•	•	•
S165190130	165.00	190.00	13.00	X	•	X	X	X	X	•	•	•	•
S165190150	165.00	190.00	15.00	•	•	X	X	•	X	•	•	•	•
S165191150	165.00	191.00	15.00	X	•	•	•	•	•	•	•	•	•
S165195130	165.00	195.00	13.00	X	•	•	•	•	•	•	•	•	•
S165195150	165.00	195.00	15.00	•	•	•	X	•	•	•	•	•	•
S165195160	165.00	195.00	16.00	•	•	•	X	•	•	•	•	•	•
S165200150	165.00	200.00	15.00	X	•	X	X	•	•	•	•	•	•
S168190150	168.00	190.00	15.00	•	•	X	•	•	•	•	•	•	•
S168200120	168.00	200.00	12.00	•	•	X	•	•	•	•	•	•	•
S168200150	168.00	200.00	15.00	•	•	X	•	•	•	•	•	•	•
S169190100	169.00	190.00	10.00	•	•	X	•	•	•	•	•	•	•
S170190130	170.00	190.00	13.00	X	•	•	X	•	•	•	•	•	•
S170190150	170.00	190.00	15.00	X	•	X	•	•	•	•	•	•	•
S170195180	170.00	195.00	18.00	•	•	•	•	X	•	•	•	•	•
S170200120	170.00	200.00	12.00	X	•	•	•	•	•	•	•	•	•
S170200130	170.00	200.00	13.00	•	•	X	•	•	X	•	•	•	•
S170200140	170.00	200.00	14.00	X	•	•	•	•	•	•	•	•	•
S170200150	170.00	200.00	15.00	X	X	X	X	X	•	•	•	•	•
S170200160	170.00	200.00	16.00	X	•	•	X	•	X	•	•	•	•
S170205150	170.00	205.00	15.00	•	•	•	X	•	•	•	•	•	•
S170205160	170.00	205.00	16.00	•	•	•	X	•	•	•	•	•	•
S170210140	170.00	210.00	14.00	X	•	•	•	•	•	•	•	•	•
S170210150	170.00	210.00	15.00	•	X	•	X	•	•	•	•	•	•
S170210200	170.00	210.00	20.00	•	•	X	•	•	•	•	•	•	•
S170215160	170.00	215.00	16.00	•	•	X	•	•	•	•	•	•	•
S170220150	170.00	220.00	15.00	X	•	•	•	•	•	•	•	•	•
S170225160	170.00	225.00	16.00	•	•	X	•	•	•	•	•	•	•
S170225200	170.00	225.00	20.00	•	•	•	X	•	•	•	•	•	•
S170225230	170.00	225.00	23.00	•	•	•	X	•	•	•	•	•	•
S170245160	170.00	245.00	16.00	•	•	X	•	•	•	•	•	•	•
S172200150	172.00	200.00	15.00	•	•	X	•	•	•	•	•	•	•
S174230225	174.00	230.00	22.50	•	•	•	X	•	•	•	•	•	•
S175191120	175.00	191.00	12.00	•	•	•	X	•	•	•	•	•	•
S175195130	175.00	195.00	13.00	X	•	•	•	•	•	•	•	•	•
S175200100	175.00	200.00	10.00	X	•	•	•	•	•	•	•	•	•
S175200150	175.00	200.00	15.00	X	•	X	•	•	•	•	•	•	•
S175205150	175.00	205.00	15.00	X	•	•	•	•	•	•	•	•	•

X: EXISTING TOOLING ••: ON REQUEST



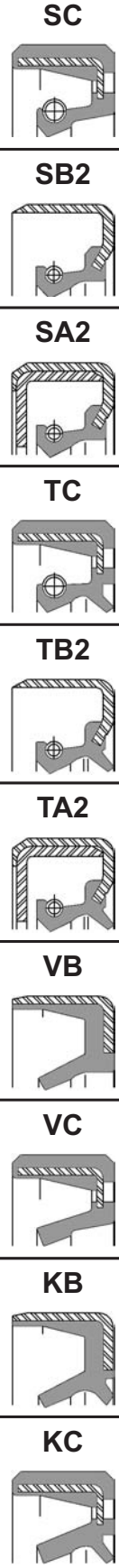





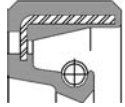

N.B.: MINIMUM LINE ORDER MAY APPLY



## GLOBAL AVAILABILITY LIST

## RADIAL SHAFT SEALS - NBR/STEEL

METRIC SIZE  
SHAFT SEALS

SC 	Ref. Number	Dimensions			DESIGN TYPE									
		d	D	H	SC	SB2	SA2	TC	TB2	TA2	VB	VC	KB	KC
	S175210140	175.00	210.00	14.00	X	•	•	•	•	•	•	•	•	•
	S175210150	175.00	210.00	15.00	•	•	X	•	•	X	•	•	•	•
	S175215160	175.00	215.00	16.00	•	•	X	•	•	•	•	•	•	•
	S175220170	175.00	220.00	17.00	X	•	•	•	•	•	•	•	•	•
	S175250160	175.00	250.00	16.00	X	•	•	•	•	•	•	•	•	•
	S176214120	176.00	214.00	12.00	•	•	•	•	•	•	•	X	•	•
	S177250160	177.00	250.00	16.00	X	•	•	•	•	•	•	•	•	•
	S178200120	178.00	200.00	12.00	•	•	X	•	•	•	•	•	•	•
	S178200150	178.00	200.00	15.00	•	•	X	•	•	•	•	•	•	•
	S178208150	178.00	208.00	15.00	X	•	•	•	•	•	•	•	•	•
	S178215160	178.00	215.00	16.00	•	•	X	•	•	•	•	•	•	•
	S178216155	178.00	216.00	15.50	•	•	X	•	•	•	•	•	•	•
	S180200100	180.00	200.00	10.00	X	•	•	•	•	•	•	•	•	•
	S180200130	180.00	200.00	13.00	X	•	•	•	X	•	•	•	•	•
	S180200150	180.00	200.00	15.00	X	•	X	X	X	•	•	•	•	•
	S180200160	180.00	200.00	16.00	•	•	•	X	X	•	•	•	•	•
	S180210100	180.00	210.00	10.00	X	•	•	X	•	•	•	•	•	•
	S180210140	180.00	210.00	14.00	•	•	•	X	•	•	•	•	•	•
	S180210150	180.00	210.00	15.00	X	X	X	X	•	•	•	•	•	•
	S180210160	180.00	210.00	16.00	•	•	•	X	X	•	•	•	•	•
	S180215150	180.00	215.00	15.00	•	•	X	X	•	X	•	•	•	•
	S180215160	180.00	215.00	16.00	X	X	X	X	•	•	•	•	•	•
	S180220130	180.00	220.00	13.00	•	•	•	X	•	•	•	•	•	•
	S180220150	180.00	220.00	15.00	X	•	•	X	•	X	•	•	•	•
	S180220160	180.00	220.00	16.00	X	•	X	•	•	•	•	•	•	•
	S180220160	180.00	220.00	16.00	X	•	X	•	•	•	•	•	•	•
	S180250050	180.00	250.00	5.00	•	•	X	•	•	•	•	•	•	•
	S182215160	182.00	215.00	16.00	•	•	X	•	•	•	•	•	•	•
	S185210130	185.00	210.00	13.00	X	•	X	X	•	•	•	•	•	•
	S185210150	185.00	210.00	15.00	•	•	•	X	•	•	•	•	•	•
	S185215130	185.00	215.00	13.00	•	X	•	•	•	•	•	•	•	•
	S185215150	185.00	215.00	15.00	X	•	X	•	•	•	•	•	•	•
	S185215160	185.00	215.00	16.00	X	•	•	•	•	•	•	•	•	•
	S185230160	185.00	230.00	16.00	X	X	X	•	•	•	•	•	•	•
	S185250240	185.00	250.00	24.00	•	•	•	X	•	•	•	•	•	•
	S186216120	186.00	216.00	12.00	•	•	X	•	•	•	•	•	•	•
	S188215160	188.00	215.00	16.00	•	•	X	•	•	•	•	•	•	•
	S188238160	188.00	238.00	16.00	•	•	•	X	•	•	•	•	•	•
	S190200160	190.00	200.00	16.00	•	X	•	•	•	•	•	•	•	•
	S190215150	190.00	215.00	15.00	•	X	X	X	•	•	•	•	•	•
	S190215160	190.00	215.00	16.00	•	•	X	X	•	•	•	•	•	•
	S190220120	190.00	220.00	12.00	X	•	X	X	•	X	•	•	•	•
	S190220150	190.00	220.00	15.00	X	X	X	X	•	•	•	•	•	•
	S190220160	190.00	220.00	16.00	X	•	X	•	•	•	•	•	•	•
	S190225120	190.00	225.00	12.00	X	•	•	•	•	•	•	•	•	•
	S190225150	190.00	225.00	15.00	X	X	X	X	•	•	•	•	•	•
	S190225160	190.00	225.00	16.00	X	•	•	X	•	•	•	•	•	•
	S190230150	190.00	230.00	15.00	X	X	•	X	•	X	•	•	•	•
	S190230160	190.00	230.00	16.00	•	•	X	X	•	•	•	•	•	•

X: EXISTING TOOLING    •: ON REQUEST

N.B.: MINIMUM LINE ORDER MAY APPLY

Tel.: (418) 688-3202  
Fax: (418) 688-4272

**SS 217**

[www.sealsonline.com](http://www.sealsonline.com)



**M**

## RADIAL SHAFT SEALS - NBR/STEEL

## GLOBAL AVAILABILITY LIST

Ref. Number	Dimensions			DESIGN TYPE										SC 
	d	D	H	SC	SB2	SA2	TC	TB2	TA2	VB	VC	KB	KC	
S190240150	190.00	240.00	15.00	•	•	•	X	•	•	•	•	•	•	
S190240250	190.00	240.00	25.00	•	•	•	X	•	•	•	•	•	•	
S190250160	190.00	250.00	16.00	•	•	X	•	•	•	•	•	•	•	
S192210100	192.00	210.00	10.00	X	X	•	•	•	•	•	•	•	•	
S194222120	194.00	222.00	12.00	•	•	X	•	•	•	•	•	•	•	
S195215150	195.00	215.00	15.00	X	•	•	•	•	•	•	•	•	•	
S195220160	195.00	220.00	16.00	•	•	X	•	•	•	•	•	•	•	
S195230150	195.00	230.00	15.00	X	•	X	•	•	•	•	•	•	•	
S195230160	195.00	230.00	16.00	X	•	X	•	•	•	•	•	•	•	
S195230170	195.00	230.00	17.00	X	•	•	•	•	•	•	•	•	•	
S195231200	195.00	231.00	20.00	•	•	•	X	•	•	•	•	•	•	
S195235150	195.00	235.00	15.00	X	•	•	X	•	•	•	•	•	•	
S195235160	195.00	235.00	16.00	•	•	•	X	•	•	•	•	•	•	
S195250220	195.00	250.00	22.00	•	•	•	X	•	•	•	•	•	•	
S195255200	195.00	255.00	20.00	•	•	•	X	•	•	•	•	•	•	
S198230120	198.00	230.00	12.00	X	•	•	•	•	•	•	•	•	•	
S198230150	198.00	230.00	15.00	•	•	•	X	•	•	•	•	•	•	
S200225120	200.00	225.00	12.00	•	•	X	•	•	•	•	•	•	•	
S200225125	200.00	225.00	12.50	•	•	X	•	•	•	•	•	•	•	
S200225150	200.00	225.00	15.00	X	•	•	•	•	•	•	•	•	•	
S200230130	200.00	230.00	13.00	X	•	•	•	•	•	•	•	•	•	
S200230150	200.00	230.00	15.00	X	X	X	X	X	X	•	•	•	•	
S200230160	200.00	230.00	16.00	X	X	X	X	•	•	•	•	•	•	
S200230180	200.00	230.00	18.00	•	•	•	•	•	X	•	•	•	•	
S200235160	200.00	235.00	16.00	X	•	•	•	•	•	•	•	•	•	
S200235180	200.00	235.00	18.00	X	•	•	X	•	•	•	•	•	•	
S200240150	200.00	240.00	15.00	X	X	X	•	•	X	•	•	•	•	
S200240160	200.00	240.00	16.00	•	•	X	•	•	•	•	•	•	•	
S200240180	200.00	240.00	18.00	•	•	•	X	•	•	•	•	•	•	
S200240200	200.00	240.00	20.00	•	•	•	X	•	X	•	•	•	•	
S200245150	200.00	245.00	15.00	•	•	X	•	•	•	•	•	•	•	
S200250150	200.00	250.00	15.00	X	•	X	•	•	•	•	•	•	•	
S200250160	200.00	250.00	16.00	•	•	X	•	•	•	•	•	•	•	
S200255150	200.00	255.00	15.00	X	•	•	•	•	•	•	•	•	•	
S200255220	200.00	255.00	22.00	•	•	•	X	•	•	•	•	•	•	
S203230120	203.00	230.00	12.00	•	•	•	•	•	X	•	•	•	•	
S203230140	203.00	230.00	14.00	•	•	X	•	•	•	•	•	•	•	
S205230150	205.00	230.00	15.00	X	X	X	•	•	•	•	•	•	•	
S205230160	205.00	230.00	16.00	X	•	X	•	•	•	•	•	•	•	
S205250160	205.00	250.00	16.00	X	•	X	•	•	•	•	•	•	•	
S207240160	207.00	240.00	16.00	•	•	•	X	•	•	•	•	•	•	
S210230160	210.00	230.00	16.00	•	•	X	•	•	•	•	•	•	•	
S210235120	210.00	235.00	12.00	•	•	•	•	•	•	•	•	•	•	
S210236120	210.00	236.00	12.00	•	•	•	•	•	•	•	X	•	•	
S210240150	210.00	240.00	15.00	X	•	X	X	•	X	•	•	•	•	
S210240160	210.00	240.00	16.00	•	•	X	•	•	•	•	•	•	•	
S210250130	210.00	250.00	13.00	•	•	X	•	•	•	•	•	•	•	
S210250150	210.00	250.00	15.00	X	•	X	X	•	X	•	•	•	•	

X: EXISTING TOOLING •: ON REQUEST

N.B.: MINIMUM LINE ORDER MAY APPLY



## GLOBAL AVAILABILITY LIST

## RADIAL SHAFT SEALS - NBR/STEEL

METRIC SIZE  
SHAFT SEALS

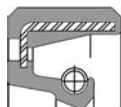
SC 	Ref. Number	Dimensions			DESIGN TYPE									
		d	D	H	SC	SB2	SA2	TC	TB2	TA2	VB	VC	KB	KC
	S210250160	210.00	250.00	16.00	X	•	X	•	•	•	•	•	•	•
	S210250200	210.00	250.00	20.00	•	•	•	•	•	X	•	•	•	•
	S210260150	210.00	260.00	15.00	•	•	X	•	•	•	•	•	•	•
	S210260250	210.00	260.00	25.00	•	•	X	•	•	•	•	•	•	•
	S210265180	210.00	265.00	18.00	•	•	•	X	•	•	•	•	•	•
	S210265250	210.00	265.00	25.00	X	•	•	•	•	•	•	•	•	•
	S210275260	210.00	275.00	26.00	•	•	•	X	•	•	•	•	•	•
	S210290200	210.00	290.00	20.00	X	•	•	X	•	•	•	•	•	•
	S212245160	212.00	245.00	16.00	X	X	•	•	•	•	•	•	•	•
	S212250150	212.00	250.00	15.00	•	•	X	•	•	•	•	•	•	•
	S215240120	215.00	240.00	12.00	X	•	X	•	•	•	•	•	•	•
	S215240150	215.00	240.00	15.00	X	•	•	•	•	•	•	•	•	•
	S215245150	215.00	245.00	15.00	•	•	•	X	•	•	•	•	•	•
	S215245160	215.00	245.00	16.00	•	•	X	•	•	•	•	•	•	•
	S215250150	215.00	250.00	15.00	•	•	X	•	•	•	•	•	•	•
	S215275260	215.00	275.00	26.00	•	•	•	X	•	•	•	•	•	•
	S218250160	218.00	250.00	16.00	•	•	X	•	•	•	•	•	•	•
	S220245080	220.00	245.00	8.00	X	•	•	•	•	•	•	•	•	•
	S220250110	220.00	250.00	11.00	•	X	•	•	•	•	•	•	•	•
	S220250120	220.00	250.00	12.00	X	•	•	•	•	•	•	•	•	•
	S220250140	220.00	250.00	14.00	X	•	•	•	•	•	•	•	•	•
	S220250150	220.00	250.00	15.00	X	X	X	X	•	X	•	•	•	•
	S220250160	220.00	250.00	16.00	X	•	•	•	X	X	•	•	•	•
	S220250180	220.00	250.00	18.00	•	•	•	•	•	X	•	•	•	•
	S220255160	220.00	255.00	16.00	X	•	•	•	•	•	•	•	•	•
	S220255180	220.00	255.00	18.00	X	•	•	•	•	•	•	•	•	•
	S220260140	220.00	260.00	14.00	•	•	•	X	•	•	•	•	•	•
	S220260150	220.00	260.00	15.00	X	•	X	•	•	•	•	•	•	•
	S220260160	220.00	260.00	16.00	X	•	•	•	•	•	•	•	•	•
	S220260180	220.00	260.00	18.00	•	•	X	•	•	•	•	•	•	•
	S220260220	220.00	260.00	22.00	X	•	X	•	•	X	•	•	•	•
	S220270150	220.00	270.00	15.00	•	•	X	•	•	•	•	•	•	•
	S220275230	220.00	275.00	23.00	•	•	•	X	•	•	•	•	•	•
	S225250125	225.00	250.00	12.50	•	•	X	•	•	•	•	•	•	•
	S225250150	225.00	250.00	15.00	X	•	•	•	•	•	•	•	•	•
	S225250160	225.00	250.00	16.00	•	•	X	•	•	•	•	•	•	•
	S225260150	225.00	260.00	15.00	•	•	X	X	•	•	•	•	•	•
	S225270160	225.00	270.00	16.00	•	X	X	•	•	•	•	•	•	•
	S229255150	229.00	255.00	15.00	•	•	X	•	•	•	•	•	•	•
	S230250150	230.00	250.00	15.00	X	•	•	•	•	•	•	•	•	•
	S230250200	230.00	250.00	20.00	•	•	•	•	•	X	•	•	•	•
	S230255100	230.00	255.00	10.00	•	X	X	•	•	•	•	•	•	•
	S230255150	230.00	255.00	15.00	X	•	X	•	•	•	•	•	•	•
	S230260150	230.00	260.00	15.00	X	X	X	X	•	•	•	•	•	•
	S230260200	230.00	260.00	20.00	•	•	•	X	•	•	•	•	•	•
	S230269220	230.00	269.00	22.00	X	•	•	•	•	•	•	•	•	•
	S230270150	230.00	270.00	15.00	X	•	X	X	•	•	•	•	•	•

X: EXISTING TOOLING    •: ON REQUEST

N.B.: MINIMUM LINE ORDER MAY APPLY

Tel.: (514) 334-2220  
Fax: (514) 333-8329

**SS 219**

[www.sealsonline.com](http://www.sealsonline.com)



## RADIAL SHAFT SEALS - NBR/STEEL

## GLOBAL AVAILABILITY LIST

Ref. Number	Dimensions			DESIGN TYPE									SC
	d	D	H	SC	SB2	SA2	TC	TB2	TA2	VB	VC	KB	
S230270160	230.00	270.00	16.00	•	X	X	•	•	X	•	•	•	•
S230270220	230.00	270.00	22.00	•	•	•	X	•	•	•	•	•	•
S230280150	230.00	280.00	15.00	X	•	•	•	•	•	•	•	•	•
S230280160	230.00	280.00	16.00	X	•	X	•	•	•	•	•	•	•
S230285230	230.00	285.00	23.00	•	•	X	X	X	•	•	•	•	•
S235270150	235.00	270.00	15.00	•	•	X	•	•	•	•	•	•	•
S235270160	235.00	270.00	16.00	•	X	X	•	•	•	•	•	•	•
S240265150	240.00	265.00	15.00	•	•	•	X	•	•	•	•	•	•
S240270140	240.00	270.00	14.00	•	•	•	X	•	•	•	•	•	•
S240270150	240.00	270.00	15.00	X	X	X	X	•	X	•	•	•	•
S240270160	240.00	270.00	16.00	•	•	X	•	•	•	•	•	•	•
S240273160	240.00	273.00	16.00	•	•	•	X	•	•	•	•	•	•
S240275160	240.00	275.00	16.00	X	•	•	•	•	•	•	•	•	•
S240275180	240.00	275.00	18.00	X	X	X	•	•	•	•	•	•	•
S240280140	240.00	280.00	14.00	•	X	•	•	•	•	•	•	•	•
S240280150	240.00	280.00	15.00	X	•	•	•	•	•	•	•	•	•
S240280160	240.00	280.00	16.00	X	X	X	•	•	X	•	•	•	•
S240280190	240.00	280.00	19.00	X	•	•	•	•	•	•	•	•	•
S240280200	240.00	280.00	20.00	•	•	•	•	•	X	•	•	•	•
S240290160	240.00	290.00	16.00	•	•	X	•	•	•	•	•	•	•
S240300180	240.00	300.00	18.00	•	•	X	•	•	•	•	•	•	•
S245270160	245.00	270.00	16.00	•	X	X	•	•	•	•	•	•	•
S245285165	245.00	285.00	16.50	•	•	X	•	•	•	•	•	•	•
S250280140	250.00	280.00	14.00	•	•	X	•	•	•	•	•	•	•
S250280150	250.00	280.00	15.00	X	X	X	•	•	X	•	•	•	•
S250280160	250.00	280.00	16.00	X	•	X	X	•	•	•	•	•	•
S250285180	250.00	285.00	18.00	•	X	X	•	•	•	•	•	•	•
S250290150	250.00	290.00	15.00	X	•	X	•	•	•	•	•	•	•
S250290160	250.00	290.00	16.00	X	X	X	•	•	X	•	•	•	•
S260280160	260.00	280.00	16.00	•	•	X	•	•	•	•	•	•	•
S260290150	260.00	290.00	15.00	X	•	•	•	•	•	•	•	•	•
S260290160	260.00	290.00	16.00	X	•	X	•	•	X	•	•	•	•
S260290200	260.00	290.00	20.00	•	•	X	•	•	•	•	•	•	•
S260300150	260.00	300.00	15.00	X	X	•	•	•	•	•	•	•	•
S260300160	260.00	300.00	16.00	•	•	X	•	•	•	•	•	•	•
S260300180	260.00	300.00	18.00	X	X	•	X	•	•	•	•	•	•
S260300200	260.00	300.00	20.00	X	X	X	•	•	X	•	•	•	•
S260300220	260.00	300.00	22.00	•	X	•	•	•	•	•	•	•	•
S260310160	260.00	310.00	16.00	•	•	X	•	•	•	•	•	•	•
S260320250	260.00	320.00	25.00	•	•	X	•	•	X	•	•	•	•
S260330200	260.00	330.00	20.00	•	•	X	•	•	•	•	•	•	•
S264290150	264.00	290.00	15.00	•	•	X	•	•	•	•	•	•	•
S265290150	265.00	290.00	15.00	•	•	X	•	•	•	•	•	•	•
S265290160	265.00	290.00	16.00	X	•	X	•	•	•	•	•	•	•
S265300160	265.00	300.00	16.00	•	•	X	•	•	•	•	•	•	•
S265310160	265.00	310.00	16.00	•	•	X	•	•	•	•	•	•	•
S267300200	267.00	300.00	20.00	•	•	X	•	•	•	•	•	•	•
S268300160	268.00	300.00	16.00	•	•	X	•	•	•	•	•	•	•

X: EXISTING TOOLING •: ON REQUEST



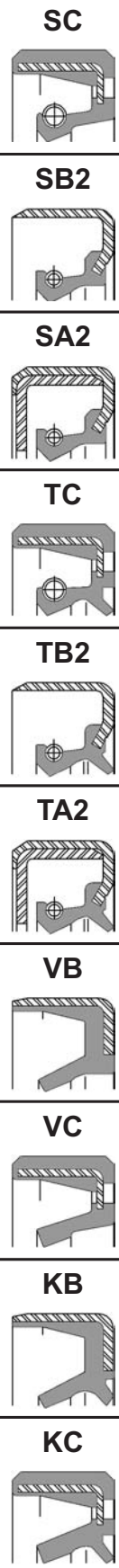





N.B.: MINIMUM LINE ORDER MAY APPLY

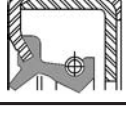

## GLOBAL AVAILABILITY LIST

## RADIAL SHAFT SEALS - NBR/STEEL

METRIC SIZE  
SHAFT SEALS

SC 	Ref. Number	Dimensions			DESIGN TYPE									
		d	D	H	SC	SB2	SA2	TC	TB2	TA2	VB	VC	KB	KC
	S270300150	270.00	300.00	15.00	X	X	.	.	.	.	.	.	.	.
	S270310150	270.00	310.00	15.00	X	.	.	.	.	.	.	.	.	.
	S270310160	270.00	310.00	16.00	.	.	X	X	.	X	.	.	.	.
<b>SB2</b> 	S270310180	270.00	310.00	18.00	.	.	X	.	.	.	.	.	.	.
	S270310200	270.00	310.00	20.00	X	.	.	.	.	.	.	.	.	.
	S270330200	270.00	330.00	20.00	.	.	.	X	.	.	.	.	.	.
	S270330250	270.00	330.00	25.00	.	.	X	.	.	.	.	.	.	.
	S272310160	272.00	310.00	16.00	.	.	X	.	.	.	.	.	.	.
<b>SA2</b> 	S275294120	275.00	294.00	12.00	X	.	.	.	.	.	.	.	.	.
	S275310150	275.00	310.00	15.00	.	.	X	.	.	.	.	.	.	.
	S275310160	275.00	310.00	16.00	.	.	X	.	.	.	.	.	.	.
	S280310150	280.00	310.00	15.00	X	.	X	X	.	.	.	.	.	.
	S280310160	280.00	310.00	16.00	.	.	X	X	.	X	.	.	.	.
<b>TC</b> 	S280316180	280.00	316.00	18.00	.	.	X	.	.	.	.	.	.	.
	S280320150	280.00	320.00	15.00	X	.	.	.	.	.	.	.	.	.
	S280320160	280.00	320.00	16.00	.	.	X	.	.	X	.	.	.	.
	S280320180	280.00	320.00	18.00	X	.	X	.	.	.	.	.	.	.
	S280320200	280.00	320.00	20.00	X	X	X	.	.	X	.	.	.	.
<b>TB2</b> 	S280324250	280.00	324.00	25.00	.	.	X	.	.	.	.	.	.	.
	S280380200	280.00	380.00	20.00	.	.	X	.	.	.	.	.	.	.
	S280400150	280.00	400.00	15.00	.	.	X	.	.	.	.	.	.	.
	S285310160	285.00	310.00	16.00	.	.	X	.	.	.	.	.	.	.
	S285320160	285.00	320.00	16.00	.	.	X	.	.	.	.	.	.	.
<b>TA2</b> 	S285325150	285.00	325.00	15.00	.	.	X	.	.	.	.	.	.	.
	S285325160	285.00	325.00	16.00	X	.	X	.	.	.	.	.	.	.
	S285330200	285.00	330.00	20.00	.	.	X	.	.	.	.	.	.	.
	S287330180	287.00	330.00	18.00	X	.	.	.	.	.	.	.	.	.
	S290330150	290.00	330.00	15.00	.	.	X	.	.	.	.	.	.	.
<b>VB</b> 	S290330160	290.00	330.00	16.00	.	.	X	.	.	.	.	.	.	.
	S290330180	290.00	330.00	18.00	.	.	X	.	.	.	.	.	.	.
	S290334200	290.00	334.00	20.00	.	.	X	.	.	.	.	.	.	.
	S290350250	290.00	350.00	25.00	.	.	X	.	.	.	.	.	.	.
	S295335160	295.00	335.00	16.00	.	.	X	.	.	.	.	.	.	.
<b>VC</b> 	S295335180	295.00	335.00	18.00	.	.	X	.	.	.	.	.	.	.
	S300332160	300.00	332.00	16.00	.	.	X	.	.	X	.	.	.	.
	S300335180	300.00	335.00	18.00	.	.	X	.	.	.	.	.	.	.
	S300340160	300.00	340.00	16.00	X	.	X	.	.	.	.	.	.	.
	S300340180	300.00	340.00	18.00	X	.	X	X	.	.	.	.	.	.
<b>KB</b> 	S300340200	300.00	340.00	20.00	X	.	X	X	.	X	.	.	.	.
	S300342160	300.00	342.00	16.00	.	.	X	.	.	.	.	.	.	.
	S300344205	300.00	344.00	20.50	.	.	X	.	.	.	.	.	.	.
	S300350180	300.00	350.00	18.00	.	.	X	.	.	.	.	.	.	.
	S300350190	300.00	350.00	19.00	.	.	X	.	.	.	.	.	.	.
<b>KC</b> 	S300350200	300.00	350.00	20.00	.	.	X	.	.	.	.	.	.	.
	S300360180	300.00	360.00	18.00	.	.	X	.	.	.	.	.	.	.
	S300400180	300.00	400.00	18.00	.	.	X	.	.	.	.	.	.	.
	S300420200	300.00	420.00	20.00	.	.	X	.	.	.	.	.	.	.
	S305330130	305.00	330.00	13.00	X	.	.	.	.	.	.	.	.	.

X: EXISTING TOOLING    .: ON REQUEST

N.B.: MINIMUM LINE ORDER MAY APPLY

Tel.: (888) 238-5885  
Fax: (888) 238-1664

**SS 221**

[www.sealsonline.com](http://www.sealsonline.com)



**M**

## RADIAL SHAFT SEALS - NBR/STEEL

## GLOBAL AVAILABILITY LIST

Ref. Number	Dimensions			DESIGN TYPE									SC
	d	D	H	SC	SB2	SA2	TC	TB2	TA2	VB	VC	KB	
S305340180	305.00	340.00	18.00	•	•	X	•	•	•	•	•	•	•
S305345200	305.00	345.00	20.00	•	•	X	•	•	•	•	•	•	•
S310340150	310.00	340.00	15.00	•	•	•	X	•	•	•	•	•	•
S310350180	310.00	350.00	18.00	X	•	X	•	•	•	•	•	•	•
S310350200	310.00	350.00	20.00	•	•	•	X	•	•	•	•	•	•
S310370280	310.00	370.00	28.00	•	•	X	•	•	•	•	•	•	•
S315350165	315.00	350.00	16.50	•	•	X	•	•	•	•	•	•	•
S315350180	315.00	350.00	18.00	2	•	X	•	•	•	•	•	•	•
S315365160	315.00	365.00	16.00	•	•	X	•	•	•	•	•	•	•
S315365200	315.00	365.00	20.00	•	•	X	•	•	•	•	•	•	•
S320350160	320.00	350.00	16.00	•	•	X	•	•	•	•	•	•	•
S320350180	320.00	350.00	18.00	•	•	X	•	•	•	•	•	•	•
S320360150	320.00	360.00	15.00	•	•	X	•	•	•	•	•	•	•
S320360180	320.00	360.00	18.00	X	•	X	•	•	•	•	•	•	•
S320360200	320.00	360.00	20.00	X	•	X	X	•	X	•	•	•	•
S320360250	320.00	360.00	25.00	•	•	X	•	•	•	•	•	•	•
S320360320	320.00	360.00	32.00	•	•	X	•	•	•	•	•	•	•
S320380200	320.00	380.00	20.00	•	•	X	•	•	•	•	•	•	•
S320380250	320.00	380.00	25.00	•	•	X	•	•	•	•	•	•	•
S325360160	325.00	360.00	16.00	•	•	X	•	•	•	•	•	•	•
S325365160	325.00	365.00	16.00	•	•	X	•	•	•	•	•	•	•
S330360150	330.00	360.00	15.00	•	•	X	•	•	•	•	•	•	•
S330370180	330.00	370.00	18.00	X	•	X	•	•	X	•	•	•	•
S330370200	330.00	370.00	20.00	•	•	X	•	•	•	•	•	•	•
S330380200	330.00	380.00	20.00	•	•	X	•	•	•	•	•	•	•
S330390250	330.00	390.00	25.00	X	•	•	•	•	•	•	•	•	•
S340372160	340.00	372.00	16.00	•	X	X	•	•	X	•	•	•	•
S340380160	340.00	380.00	16.00	•	•	X	•	•	•	•	•	•	•
S340380180	340.00	380.00	18.00	X	•	X	•	•	•	•	•	•	•
S340380200	340.00	380.00	20.00	X	•	X	•	•	X	•	•	•	•
S340390200	340.00	390.00	20.00	•	•	X	•	•	•	•	•	•	•
S340390250	340.00	390.00	25.00	X	•	•	•	•	•	•	•	•	•
S340400250	340.00	400.00	25.00	•	•	X	•	•	•	•	•	•	•
S350380160	350.00	380.00	16.00	•	•	X	•	•	•	•	•	•	•
S350390180	350.00	390.00	18.00	X	•	X	•	•	X	•	•	•	•
S350390200	350.00	390.00	20.00	X	•	•	•	•	X	•	•	•	•
S355395320	355.00	395.00	32.00	•	•	X	•	•	•	•	•	•	•
S355405150	355.00	405.00	15.00	•	•	X	•	•	•	•	•	•	•
S360390150	360.00	390.00	15.00	•	•	•	X	•	•	•	•	•	•
S360390180	360.00	390.00	18.00	X	•	•	•	•	•	•	•	•	•
S360390200	360.00	390.00	20.00	•	•	X	•	•	•	•	•	•	•
S360392200	360.00	392.00	20.00	•	•	X	•	•	X	•	•	•	•
S360400160	360.00	400.00	16.00	X	•	•	•	•	•	•	•	•	•
S360400180	360.00	400.00	18.00	X	•	X	•	•	•	•	•	•	•
S360400200	360.00	400.00	20.00	X	•	X	•	•	X	•	•	•	•
S360425200	360.00	425.00	20.00	•	•	X	•	•	•	•	•	•	•
S365395150	365.00	395.00	15.00	•	•	X	•	•	•	•	•	•	•
S365405180	365.00	405.00	18.00	•	•	X	•	•	•	•	•	•	•

X: EXISTING TOOLING •: ON REQUEST



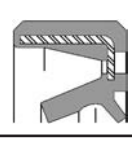
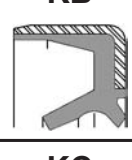
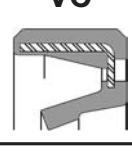
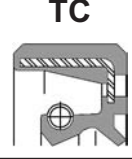
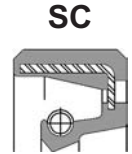







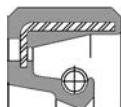



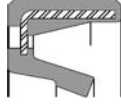

N.B.: MINIMUM LINE ORDER MAY APPLY

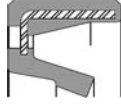

## GLOBAL AVAILABILITY LIST

## RADIAL SHAFT SEALS - NBR/STEEL

METRIC SIZE  
SHAFT SEALS

SC 	Ref. Number	Dimensions			DESIGN TYPE									
		d	D	H	SC	SB2	SA2	TC	TB2	TA2	VB	VC	KB	KC
	S365410200	365.00	410.00	20.00	•	•	X	•	•	•	•	•	•	•
	S370400100	370.00	400.00	10.00	•	•	X	•	•	•	•	•	•	•
	S370410150	370.00	410.00	15.00	X	•	X	•	•	•	•	•	•	•
	S370410200	370.00	410.00	20.00	•	•	X	•	•	X	•	•	•	•
	S375420180	375.00	420.00	18.00	•	•	X	•	•	•	•	•	•	•
	S375430180	375.00	430.00	18.00	•	•	X	•	•	•	•	•	•	•
	S380420180	380.00	420.00	18.00	•	•	X	•	•	•	•	•	•	•
	S380420200	380.00	420.00	20.00	X	•	X	X	•	•	•	•	•	•
	S380430190	380.00	430.00	19.00	•	•	X	•	•	•	•	•	•	•
	S390425180	390.00	425.00	18.00	•	•	•	•	•	X	•	•	•	•
	S390430180	390.00	430.00	18.00	•	•	X	•	•	•	•	•	•	•
	S390430200	390.00	430.00	20.00	X	•	•	•	•	•	•	•	•	•
	S390435180	390.00	435.00	18.00	•	•	•	•	•	X	•	•	•	•
	S390440250	390.00	440.00	25.00	•	•	X	•	•	•	•	•	•	•
	S394420160	394.00	420.00	16.00	X	•	X	•	•	•	•	•	•	•
	S395430150	395.00	430.00	15.00	•	•	X	•	•	•	•	•	•	•
	S395430180	395.00	430.00	18.00	•	•	X	•	•	•	•	•	•	•
	S400430260	400.00	430.00	26.00	•	•	X	•	•	•	•	•	•	•
	S400440150	400.00	440.00	15.00	•	•	X	•	•	•	•	•	•	•
	S400440180	400.00	440.00	18.00	X	•	X	•	•	•	•	•	•	•
	S400440200	400.00	440.00	20.00	X	X	X	•	•	•	•	•	•	•
	S400450180	400.00	450.00	18.00	•	•	X	•	•	•	•	•	•	•
	S400450200	400.00	450.00	20.00	•	•	X	•	•	•	•	•	•	•
	S400450250	400.00	450.00	25.00	X	•	•	•	•	X	•	•	•	•
	S400451175	400.00	451.00	17.50	•	•	X	•	•	•	•	•	•	•
	S400470200	400.00	470.00	20.00	•	•	X	•	•	•	•	•	•	•
	S400500250	400.00	500.00	25.00	•	•	X	•	•	•	•	•	•	•
	S410454205	410.00	454.00	20.50	•	•	X	•	•	•	•	•	•	•
	S410460150	410.00	460.00	15.00	•	•	X	•	•	•	•	•	•	•
	S410460220	410.00	460.00	22.00	•	•	X	•	•	•	•	•	•	•
	S420460150	420.00	460.00	15.00	•	•	X	•	•	•	•	•	•	•
	S420460180	420.00	460.00	18.00	•	•	X	•	•	•	•	•	•	•
	S420460200	420.00	460.00	20.00	X	X	X	•	•	•	•	•	•	•
	S420470150	420.00	470.00	15.00	X	•	•	•	•	•	•	•	•	•
	S420480150	420.00	480.00	15.00	•	•	X	•	•	•	•	•	•	•
	S425475220	425.00	475.00	22.00	•	•	X	•	•	•	•	•	•	•
	S425480150	425.00	480.00	15.00	•	•	X	•	•	•	•	•	•	•
	S430460140	430.00	460.00	14.00	X	•	•	•	•	•	•	•	•	•
	S430480220	430.00	480.00	22.00	•	•	X	•	•	•	•	•	•	•
	S430480250	430.00	480.00	25.00	•	•	X	•	•	•	•	•	•	•
	S440470200	440.00	470.00	20.00	•	•	X	•	•	•	•	•	•	•
	S440480200	440.00	480.00	20.00	X	X	X	X	•	•	•	•	•	•
	S440490170	440.00	490.00	17.00	•	•	X	•	•	•	•	•	•	•
	S440490200	440.00	490.00	20.00	•	•	X	•	•	•	•	•	•	•
	S445480160	445.00	480.00	16.00	•	•	X	•	•	•	•	•	•	•
	S445480180	445.00	480.00	18.00	•	•	X	•	•	•	•	•	•	•
	S448480150	448.00	480.00	15.00	•	•	X	•	•	•	•	•	•	•
	S450490180	450.00	490.00	18.00	•	•	X	•	•	•	•	•	•	•

X: EXISTING TOOLING    •: ON REQUEST

N.B.: MINIMUM LINE ORDER MAY APPLY

Tel.: (204) 783-9617  
Fax: (204) 783-6091

**SS 223**

[www.sealsonline.com](http://www.sealsonline.com)





## RADIAL SHAFT SEALS - NBR/STEEL

## GLOBAL AVAILABILITY LIST

Ref. Number	Dimensions			DESIGN TYPE									SC
	d	D	H	SC	SB2	SA2	TC	TB2	TA2	VB	VC	KB	
S450490200	450.00	490.00	20.00	•	•	X	•	•	•	•	•	•	•
S450500220	450.00	500.00	22.00	X	•	•	•	•	•	•	•	•	•
S450500250	450.00	500.00	25.00	X	•	X	•	•	•	•	•	•	•
S450510250	450.00	510.00	25.00	X	•	•	•	•	•	•	•	•	•
S455495200	455.00	495.00	20.00	•	•	X	•	•	•	•	•	•	•
S457508250	457.00	508.00	25.00	•	•	X	•	•	•	•	•	•	•
S460500200	460.00	500.00	20.00	X	•	X	•	•	•	•	•	•	•
S460510250	460.00	510.00	25.00	•	•	X	•	•	•	•	•	•	•
S460520260	460.00	520.00	26.00	•	•	X	•	•	•	•	•	•	•
S461500200	461.00	500.00	20.00	•	•	X	•	•	•	•	•	•	•
S467510200	467.00	510.00	20.00	X	•	X	•	•	•	•	•	•	•
S470510200	470.00	510.00	20.00	•	•	X	•	•	•	•	•	•	•
S470520180	470.00	520.00	18.00	•	•	X	•	•	•	•	•	•	•
S470520200	470.00	520.00	20.00	•	•	X	•	•	•	•	•	•	•
S470520220	470.00	520.00	22.00	•	•	X	•	•	•	•	•	•	•
S475530180	475.00	530.00	18.00	•	•	X	•	•	•	•	•	•	•
S480520200	480.00	520.00	20.00	X	•	X	X	•	X	•	•	•	•
S480530250	480.00	530.00	25.00	X	•	•	•	•	•	•	•	•	•
S480550250	480.00	550.00	25.00	•	•	X	•	•	•	•	•	•	•
S490530200	490.00	530.00	20.00	•	•	X	•	•	•	•	•	•	•
S500520120	500.00	520.00	12.00	•	•	X	•	•	•	•	•	•	•
S500535120	500.00	535.00	12.00	•	•	X	•	•	•	•	•	•	•
S500540200	500.00	540.00	20.00	X	•	X	X	•	•	•	•	•	•
S500550200	500.00	550.00	20.00	•	•	X	•	•	•	•	•	•	•
S500550220	500.00	550.00	22.00	•	•	X	•	•	•	•	•	•	•
S500550250	500.00	550.00	25.00	X	•	•	•	•	•	•	•	•	•
S500560200	500.00	560.00	20.00	•	•	X	•	•	•	•	•	•	•
S510550200	510.00	550.00	20.00	•	•	X	•	•	•	•	•	•	•
S510572200	510.00	572.00	20.00	•	•	X	•	•	•	•	•	•	•
S520580200	520.00	580.00	20.00	•	•	X	•	•	•	•	•	•	•
S520580250	520.00	580.00	25.00	•	X	•	•	•	•	•	•	•	•
S530565200	530.00	565.00	20.00	•	•	X	•	•	•	•	•	•	•
S530570200	530.00	570.00	20.00	•	•	X	•	•	•	•	•	•	•
S530580220	530.00	580.00	22.00	•	•	•	•	•	X	•	•	•	•
S540580200	540.00	580.00	20.00	•	•	X	•	•	•	•	•	•	•
S540590220	540.00	590.00	22.00	•	•	X	•	•	•	•	•	•	•
S550590200	550.00	590.00	20.00	•	•	X	•	•	•	•	•	•	•
S550600220	550.00	600.00	22.00	•	•	X	•	•	•	•	•	•	•
S550600250	550.00	600.00	25.00	X	•	•	•	•	•	•	•	•	•
S555600200	555.00	600.00	20.00	•	•	X	•	•	•	•	•	•	•

X: EXISTING TOOLING •: ON REQUEST

N.B.: MINIMUM LINE ORDER MAY APPLY

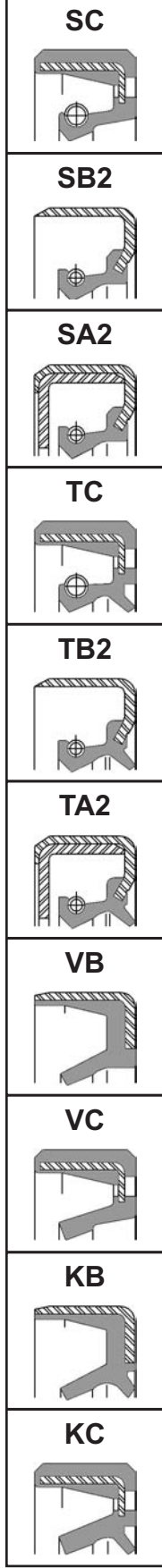

# GLOBAL AVAILABILITY FPM/STEEL



METRIC SIZE  
SHAFT SEALS

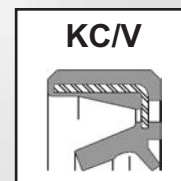
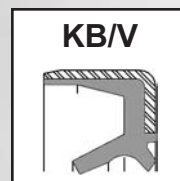
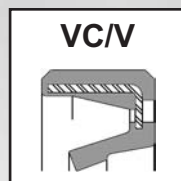
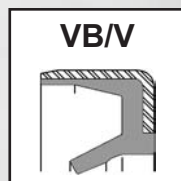
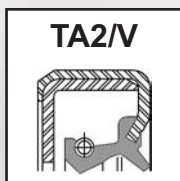
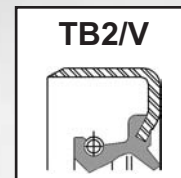
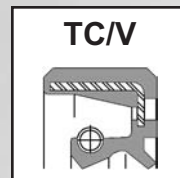
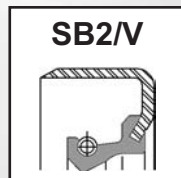
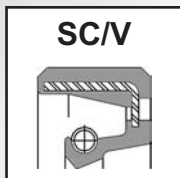

Tel.: (780) 414-1871  
Fax: (780) 487-5419

**SS 225**

[www.sealsonline.com](http://www.sealsonline.com)

## RADIAL SHAFT SEALS - FPM/STEEL

## GLOBAL AVAILABILITY LIST

Ref. Number	Dimensions			DESIGN TYPE										
	d	D	H	SC/V	SB2/V	SA2/V	TC/V	TB2/V	TA2/V	VB/V	VC/V	KB/V	KC/V	
S004008020	4.00	8.00	2.00	•	•	•	•	•	•	•	X	•	•	•
S004011060	4.00	11.00	6.00	X	•	•	•	•	•	•	•	•	•	•
S004012060	4.00	12.00	6.00	X	•	•	•	•	•	•	•	•	•	•
S005009020	5.00	9.00	2.00	•	•	•	•	•	•	•	X	•	•	•
S005015060	5.00	15.00	6.00	X	•	•	•	•	•	•	•	•	•	•
S005016070	5.00	16.00	7.00	X	•	•	•	•	•	•	•	•	•	•
S006010020	6.00	10.00	2.00	•	•	•	•	•	•	•	X	X	•	•
S006014060	6.00	14.00	6.00	X	•	•	•	•	•	•	•	•	•	•
S006015040	6.00	15.00	4.00	X	•	•	•	•	•	•	•	•	•	•
S006015060	6.00	15.00	6.00	X	•	•	•	•	•	•	•	•	•	•
S006016050	6.00	16.00	5.00	X	•	•	•	•	•	•	•	•	•	•
S006016060	6.00	16.00	6.00	X	•	•	•	•	•	•	•	•	•	•
S006016070	6.00	16.00	7.00	X	•	•	•	•	•	•	•	•	•	•
S006018050	6.00	18.00	5.00	X	•	•	•	•	•	•	•	•	•	•
S006018080	6.00	18.00	8.00	•	•	•	•	•	•	•	•	•	•	•
S006019060	6.00	19.00	6.00	X	•	•	•	•	•	•	•	•	•	•
S006019070	6.00	19.00	7.00	X	•	•	•	•	•	•	•	•	•	•
S006020060	6.00	20.00	6.00	X	•	•	•	•	•	•	•	•	•	•
S006022070	6.00	22.00	7.00	X	•	•	•	•	•	•	•	•	•	•
S006022080	6.00	22.00	8.00	X	•	•	•	•	•	•	•	•	•	•
S007011020	7.00	11.00	2.00	•	•	•	•	•	•	•	X	•	•	•
S007014020	7.00	14.00	2.00	•	•	•	•	•	•	•	X	•	•	•
S007016070	7.00	16.00	7.00	X	•	•	•	•	•	•	•	•	•	•
S007022070	7.00	22.00	7.00	X	•	•	•	•	•	•	•	•	•	•
S007022080	7.00	22.00	8.00	X	•	•	•	•	•	•	•	•	•	•
S008012030	8.00	12.00	3.00	•	•	•	•	•	•	•	X	X	•	•
S008015030	8.00	15.00	3.00	X	•	•	•	•	•	•	•	X	•	•
S008016070	8.00	16.00	7.00	X	•	•	•	•	•	•	•	•	•	•
S008018050	8.00	18.00	5.00	X	•	•	•	•	•	•	•	•	•	•
S008018060	8.00	18.00	6.00	X	•	•	•	•	•	•	•	•	•	•
S008019070	8.00	19.00	7.00	X	•	•	•	•	•	•	•	•	•	•
S008020080	8.00	20.00	8.00	X	•	•	•	•	•	•	•	•	•	•
S008022060	8.00	22.00	6.00	X	•	•	•	•	•	•	•	•	•	•
S008022070	8.00	22.00	7.00	X	•	•	X	•	•	•	•	•	•	•
S008022080	8.00	22.00	8.00	X	•	•	•	•	•	•	•	•	•	•
S008024070	8.00	24.00	7.00	X	•	•	•	•	•	•	•	•	•	•
S008030070	8.00	30.00	7.00	X	•	•	•	•	•	•	•	•	•	•
S009013030	9.00	13.00	3.00	•	•	•	•	•	•	•	•	X	•	•
S009018070	9.00	18.00	7.00	X	•	•	•	•	•	•	•	•	•	•
S009019040	9.00	19.00	4.00	X	•	•	•	•	•	•	•	•	•	•
S009022070	9.00	22.00	7.00	X	•	•	•	•	•	•	•	•	•	•
S009024070	9.00	24.00	7.00	X	•	•	•	•	•	•	•	•	•	•
S009025080	9.00	25.00	8.00	X	•	•	•	•	•	•	•	•	•	•
S009026070	9.00	26.00	7.00	X	•	•	•	•	•	•	•	•	•	•
S010014030	10.00	14.00	3.00	•	•	•	•	•	•	•	•	X	•	•
S010016040	10.00	16.00	4.00	X	•	•	•	•	•	•	•	X	•	•
S010016050	10.00	16.00	5.00	X	•	•	•	•	•	•	•	•	•	•
S010018040	10.00	18.00	4.00	X	•	•	•	•	•	•	•	•	•	•

X: EXISTING TOOLING •: ON REQUEST

N.B.: MINIMUM LINE ORDER MAY APPLY

**SC/V**

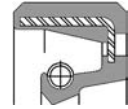

**SB2/V**

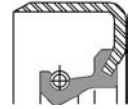

**SA2/V**



**TC/V**



**TB2/V**

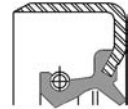

**TA2/V**



**VB/V**



**VC/V**

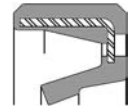

**KB/V**











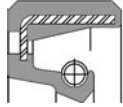

**KC/V**

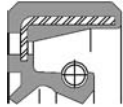

## GLOBAL AVAILABILITY LIST

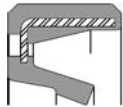
## RADIAL SHAFT SEALS - FPM/STEEL

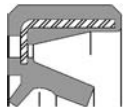
METRIC SIZE  
SHAFT SEALS

SC/V 	Ref. Number	Dimensions			DESIGN TYPE									
		d	D	H	SC/V	SB2/V	SA2/V	TC/V	TB2/V	TA2/V	VB/V	VC/V	KB/V	KC/V
	S010018050	10.00	18.00	5.00	X	.	.	.	.	.	.	.	.	.
	S010018060	10.00	18.00	6.00	X	.	.	X	.	.	.	.	.	.
	S010018090	10.00	18.00	9.00	X	.	.	.	.	.	.	.	.	.
	S010019060	10.00	19.00	6.00	X	.	.	.	.	.	.	.	.	.
	S010019070	10.00	19.00	7.00	X	.	.	.	.	.	.	.	.	.
	S010022060	10.00	22.00	6.00	X	.	.	.	.	.	.	.	.	.
	S010022070	10.00	22.00	7.00	X	.	.	.	.	.	.	.	.	.
	S010022080	10.00	22.00	8.00	X	.	.	.	.	.	.	.	.	.
	S010024070	10.00	24.00	7.00	X	.	.	.	.	.	.	.	.	.
	S010025060	10.00	25.00	6.00	X	.	.	.	.	.	.	.	.	.
	S010026070	10.00	26.00	7.00	X	.	.	.	.	.	.	.	.	.
	S010028070	10.00	28.00	7.00	X	.	.	.	.	.	.	.	.	.
	S010028080	10.00	28.00	8.00	X	.	.	.	.	.	.	.	.	.
	S010030070	10.00	30.00	7.00	X	.	.	.	.	.	.	.	.	.
	S010030080	10.00	30.00	8.00	X	.	.	.	.	.	.	.	.	.
	S011017040	11.00	17.00	4.00	X	.	.	.	.	.	.	.	.	.
	S011022070	11.00	22.00	7.00	X	.	.	.	.	.	.	.	.	.
	S011022080	11.00	22.00	8.00	X	.	.	.	.	.	.	.	.	.
	S011026060	11.00	26.00	6.00	X	.	.	.	.	.	.	.	.	.
	S011026070	11.00	26.00	7.00	X	.	.	X	.	.	.	.	.	.
	S011030070	11.00	30.00	7.00	X	.	.	.	.	.	.	.	.	.
	S012016030	12.00	16.00	3.00	.	.	.	.	.	.	X	X	.	.
	S012018030	12.00	18.00	3.00	.	.	.	.	.	.	.	X	.	.
	S012018045	12.00	18.00	4.50	X	.	.	.	.	.	.	.	.	.
	S012018050	12.00	18.00	5.00	X	.	.	.	.	.	.	.	.	.
	S012019050	12.00	19.00	5.00	X	.	.	.	.	.	.	.	.	.
	S012020050	12.00	20.00	5.00	X	.	.	.	.	.	.	.	.	.
	S012021040	12.00	21.00	4.00	X	.	.	.	.	.	.	.	.	.
	S012022040	12.00	22.00	4.00	X	.	.	.	.	.	.	.	.	.
	S012022045	12.00	22.00	4.50	X	.	.	.	.	.	.	.	.	.
	S012022060	12.00	22.00	6.00	X	.	.	.	.	.	.	.	.	.
	S012022070	12.00	22.00	7.00	X	.	.	X	.	.	.	.	.	.
	S012022080	12.00	22.00	8.00	X	.	.	.	.	.	.	.	.	.
	S012024060	12.00	24.00	6.00	X	.	.	.	.	.	.	.	.	.
	S012024065	12.00	24.00	6.50	X	.	.	.	.	.	.	.	.	.
	S012024070	12.00	24.00	7.00	X	.	.	X	.	.	.	.	.	.
	S012024080	12.00	24.00	8.00	X	.	.	.	.	.	.	.	.	.
	S012024100	12.00	24.00	10.00	.	.	.	.	.	.	.	.	.	.
	S012025050	12.00	25.00	5.00	X	.	.	.	.	.	.	.	.	.
	S012025070	12.00	25.00	7.00	X	.	.	.	.	.	.	.	.	.
	S012025080	12.00	25.00	8.00	X	.	.	.	.	.	.	.	.	.
	S012026070	12.00	26.00	7.00	X	.	.	.	.	.	.	.	.	.
	S012026080	12.00	26.00	8.00	X	.	.	.	.	.	.	.	.	.
	S012028070	12.00	28.00	7.00	X	.	.	X	.	.	.	.	.	.
	S012028080	12.00	28.00	8.00	X	.	.	.	.	.	.	.	.	.
	S012030070	12.00	30.00	7.00	X	.	.	.	.	.	.	.	.	.
	S012030100	12.00	30.00	10.00	X	.	.	.	.	.	.	.	.	.
	S012032050	12.00	32.00	5.00	X	.	.	.	.	.	.	.	.	.

X: EXISTING TOOLING \* : ON REQUEST

N.B.: MINIMUM LINE ORDER MAY APPLY

Tel.: (604) 278-6808  
Fax: (604) 278-6180

**SS 227**

[www.sealsonline.com](http://www.sealsonline.com)



**M**

## RADIAL SHAFT SEALS - FPM/STEEL

## GLOBAL AVAILABILITY LIST

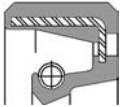
Ref. Number	Dimensions			DESIGN TYPE										SC/V 
	d	D	H	SC/V	SB2/V	SA2/V	TC/V	TB2/V	TA2/V	VB/V	VC/V	KB/V	KC/V	
S012032070	12.00	32.00	7.00	X	•	•	•	•	•	•	•	•	•	•
S012050050	12.00	50.00	5.00	X	•	•	•	•	•	•	•	•	•	•
S013022040	13.00	22.00	4.00	X	•	•	•	•	•	•	•	•	•	•
S013022050	13.00	22.00	5.00	X	•	•	•	•	•	•	•	•	•	•
S013025070	13.00	25.00	7.00	X	•	•	•	•	•	•	•	•	•	•
S013026070	13.00	26.00	7.00	X	•	•	•	•	•	•	•	•	•	•
S013030070	13.00	30.00	7.00	X	•	•	•	•	•	•	•	•	•	•
S013030080	13.00	30.00	8.00	X	•	•	•	•	•	•	•	•	•	•
S014022040	14.00	22.00	4.00	X	•	•	•	•	•	•	•	•	•	•
S014022070	14.00	22.00	7.00	X	•	•	•	•	•	•	•	•	•	•
S014024050	14.00	24.00	5.00	•	•	•	X	•	•	•	•	•	•	•
S014024060	14.00	24.00	6.00	X	•	•	•	•	•	•	•	•	•	•
S014024070	14.00	24.00	7.00	X	•	•	•	•	•	•	•	•	•	•
S014025070	14.00	25.00	7.00	X	•	•	•	•	•	•	•	•	•	•
S014026070	14.00	26.00	7.00	X	•	•	•	•	•	•	•	•	•	•
S014027070	14.00	27.00	7.00	X	•	•	•	•	•	•	•	•	•	•
S014028070	14.00	28.00	7.00	X	•	•	X	•	•	•	•	•	•	•
S014028100	14.00	28.00	10.00	X	•	•	•	•	•	•	•	•	•	•
S014030070	14.00	30.00	7.00	X	•	•	•	•	•	•	•	•	•	•
S014030080	14.00	30.00	8.00	X	•	•	•	•	•	•	•	•	•	•
S014032070	14.00	32.00	7.00	X	•	•	•	•	•	•	•	•	•	•
S014035070	14.00	35.00	7.00	X	•	•	•	•	•	•	•	•	•	•
S014035080	14.00	35.00	8.00	X	•	•	•	•	•	•	•	•	•	•
S015021040	15.00	21.00	4.00	X	•	•	•	•	•	•	•	•	•	•
S015022070	15.00	22.00	7.00	X	•	•	•	•	•	•	•	•	•	•
S015024050	15.00	24.00	5.00	X	•	•	•	•	•	•	•	•	•	•
S015024070	15.00	24.00	7.00	X	•	•	X	•	•	•	•	•	•	•
S015025050	15.00	25.00	5.00	X	•	•	•	•	•	•	•	•	•	•
S015025060	15.00	25.00	6.00	X	•	•	•	•	•	•	•	•	•	•
S015026045	15.00	26.00	4.50	X	•	•	•	•	•	•	•	•	•	•
S015026070	15.00	26.00	7.00	X	•	•	X	•	•	•	•	•	•	•
S015027070	15.00	27.00	7.00	X	•	•	•	•	•	•	•	•	•	•
S015028050	15.00	28.00	5.00	X	•	•	•	•	•	•	•	•	•	•
S015028060	15.00	28.00	6.00	X	•	•	•	•	•	•	•	•	•	•
S015028070	15.00	28.00	7.00	X	•	•	•	•	•	•	•	•	•	•
S015030045	15.00	30.00	4.50	X	•	•	•	•	•	•	•	•	•	•
S015030050	15.00	30.00	5.00	X	•	•	•	•	•	•	•	•	•	•
S015030055	15.00	30.00	5.50	X	•	•	•	•	•	•	•	•	•	•
S015030060	15.00	30.00	6.00	X	•	•	•	•	•	•	•	•	•	•
S015030070	15.00	30.00	7.00	X	•	•	X	•	•	•	•	•	•	•
S015030080	15.00	30.00	8.00	X	•	•	•	•	•	•	•	•	•	•
S015030100	15.00	30.00	10.00	X	•	•	•	•	•	•	•	•	•	•
S015032055	15.00	32.00	5.50	X	•	•	•	•	•	•	•	•	•	•
S015032070	15.00	32.00	7.00	X	•	•	•	•	•	•	•	•	•	•
S015033070	15.00	33.00	7.00	X	•	•	•	•	•	•	•	•	•	•
S015035050	15.00	35.00	5.00	X	•	•	•	•	•	•	•	•	•	•
S015035070	15.00	35.00	7.00	X	•	•	X	•	•	•	•	•	•	•
S015035080	15.00	35.00	8.00	X	•	•	•	•	•	•	•	•	•	•

X: EXISTING TOOLING •: ON REQUEST











N.B.: MINIMUM LINE ORDER MAY APPLY

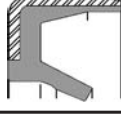
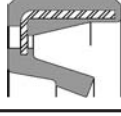

## GLOBAL AVAILABILITY LIST

## RADIAL SHAFT SEALS - FPM/STEEL

**METRIC SIZE  
SHAFT SEALS**

SC/V 	Ref. Number	Dimensions			DESIGN TYPE									
		d	D	H	SC/V	SB2/V	SA2/V	TC/V	TB2/V	TA2/V	VB/V	VC/V	KB/V	KC/V
	S015035100	15.00	35.00	10.00	X	.	.	.	.	.	.	.	.	.
	S015037070	15.00	37.00	7.00	X	.	.	.	.	.	.	.	.	.
	S015040100	15.00	40.00	10.00	X	.	.	.	.	.	.	.	.	.
	S015042070	15.00	42.00	7.00	X	.	.	.	.	.	.	.	.	.
	S015042100	15.00	42.00	10.00	X	.	.	.	.	.	.	.	.	.
	S016022030	16.00	22.00	3.00	.	.	.	.	.	.	.	X	.	.
	S016024030	16.00	24.00	3.00	.	.	.	.	.	.	.	X	.	.
	S016024040	16.00	24.00	4.00	X	.	.	.	.	.	.	.	.	.
	S016024050	16.00	24.00	5.00	X	.	.	.	.	.	.	.	.	.
	S016024070	16.00	24.00	7.00	X	.	.	.	.	.	.	.	.	.
	S016026070	16.00	26.00	7.00	X	.	.	.	.	.	.	.	.	.
	S016028070	16.00	28.00	7.00	X	.	.	X	.	.	.	.	.	.
	S016029100	16.00	29.00	10.00	X	.	.	.	.	.	.	.	.	.
	S016030045	16.00	30.00	4.50	.	.	.	X	.	.	.	.	.	.
	S016030070	16.00	30.00	7.00	X	.	.	.	.	.	.	.	.	.
	S016030080	16.00	30.00	8.00	X	.	.	.	.	.	.	.	.	.
	S016030100	16.00	30.00	10.00	X	.	.	.	.	.	.	.	.	.
	S016032070	16.00	32.00	7.00	X	.	.	X	.	.	.	.	.	.
	S016032080	16.00	32.00	8.00	X	.	.	.	.	.	.	.	.	.
	S016032100	16.00	32.00	10.00	X	.	.	.	.	.	.	.	.	.
	S016032070	16.00	32.00	7.00	X	.	.	X	.	.	.	.	.	.
	S016035070	16.00	35.00	7.00	X	.	.	.	.	.	.	.	.	.
	S016035100	16.00	35.00	10.00	X	.	.	.	.	.	.	.	.	.
	S016040100	16.00	40.00	10.00	X	.	.	.	.	.	.	.	.	.
	S017023030	17.00	23.00	3.00	.	.	.	.	.	.	.	X	.	.
	S017024050	17.00	24.00	5.00	X	.	.	.	.	.	.	.	.	.
	S017024070	17.00	24.00	7.00	X	.	.	.	.	.	.	.	.	.
	S017025040	17.00	25.00	4.00	X	.	.	.	.	.	.	.	.	.
	S017026060	17.00	26.00	6.00	X	.	.	.	.	.	.	.	.	.
	S017026070	17.00	26.00	7.00	X	.	.	.	.	.	.	.	.	.
	S017027060	17.00	27.00	6.00	X	.	.	.	.	.	.	.	.	.
	S017027070	17.00	27.00	7.00	X	.	.	.	.	.	.	.	.	.
	S017028050	17.00	28.00	5.00	X	.	.	.	.	.	.	.	.	.
	S017028060	17.00	28.00	6.00	X	.	.	X	.	.	.	.	.	.
	S017028070	17.00	28.00	7.00	X	.	.	X	.	.	.	.	.	.
	S017028080	17.00	28.00	8.00	X	.	.	.	.	.	.	.	.	.
	S017029070	17.00	29.00	7.00	.	.	.	.	.	.	.	.	.	.
	S017030060	17.00	30.00	6.00	X	.	.	.	.	.	.	.	.	.
	S017030070	17.00	30.00	7.00	X	.	.	X	.	.	.	.	.	.
	S017030080	17.00	30.00	8.00	X	.	.	.	.	.	.	.	.	.
	S017032070	17.00	32.00	7.00	X	.	.	X	.	.	.	.	.	.
	S017032080	17.00	32.00	8.00	X	.	.	.	.	.	.	.	.	.
	S017032100	17.00	32.00	10.00	X	.	.	.	.	.	.	.	.	.
	S017035050	17.00	35.00	5.00	X	.	.	.	.	.	.	.	.	.
	S017035060	17.00	35.00	6.00	X	.	.	.	.	.	.	.	.	.
	S017035070	17.00	35.00	7.00	X	.	.	.	.	.	.	.	.	.
	S017035080	17.00	35.00	8.00	X	.	.	X	.	.	.	.	.	.
	S017035095	17.00	35.00	9.50	X	.	.	.	.	.	.	.	.	.
	S017035100	17.00	35.00	10.00	X	.	.	.	.	.	.	.	.	.

X: EXISTING TOOLING    \*: ON REQUEST

N.B.: MINIMUM LINE ORDER MAY APPLY

**Tel.: (418) 688-3202**  
**Fax: (418) 688-4272**

**SS 229**

[www.sealsonline.com](http://www.sealsonline.com)



## RADIAL SHAFT SEALS - FPM/STEEL

## GLOBAL AVAILABILITY LIST

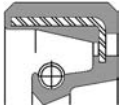
Ref. Number	Dimensions			DESIGN TYPE										SC/V 
	d	D	H	SC/V	SB2/V	SA2/V	TC/V	TB2/V	TA2/V	VB/V	VC/V	KB/V	KC/V	
S017037070	17.00	37.00	7.00	X	•	•	•	•	•	•	•	•	•	•
S017037100	17.00	37.00	10.00	X	•	•	•	•	•	•	•	•	•	•
S017038110	17.00	38.00	11.00	X	•	•	•	•	•	•	•	•	•	•
S017039095	17.00	39.00	9.50	•	•	•	X	•	•	•	•	•	•	•
S017040060	17.00	40.00	6.00	X	•	•	•	•	•	•	•	•	•	•
S017040070	17.00	40.00	7.00	X	•	•	•	•	•	•	•	•	•	•
S017040080	17.00	40.00	8.00	X	•	•	•	•	•	•	•	•	•	•
S017040085	17.00	40.00	8.50	X	•	•	•	•	•	•	•	•	•	•
S017040100	17.00	40.00	10.00	X	•	•	•	•	•	•	•	•	•	•
S017047070	17.00	47.00	7.00	X	•	•	•	•	•	•	•	•	•	•
S017047080	17.00	47.00	8.00	X	•	•	•	•	•	•	•	•	•	•
S017047100	17.00	47.00	10.00	X	•	•	•	•	•	•	•	•	•	•
S018024030	18.00	24.00	3.00	•	•	•	•	•	•	•	X	•	•	•
S018028040	18.00	28.00	4.00	X	•	•	•	•	•	•	•	•	•	•
S018028060	18.00	28.00	6.00	X	•	•	X	•	•	•	•	•	•	•
S018028070	18.00	28.00	7.00	X	•	•	•	•	•	•	•	•	•	•
S018028080	18.00	28.00	8.00	X	•	•	•	•	•	•	•	•	•	•
S018030070	18.00	30.00	7.00	X	•	•	X	•	•	•	•	•	•	•
S018032050	18.00	32.00	5.00	X	•	•	•	•	•	•	•	•	•	•
S018032060	18.00	32.00	6.00	X	•	•	•	•	•	•	•	•	•	•
S018032070	18.00	32.00	7.00	X	•	•	X	•	•	•	•	•	•	•
S018032080	18.00	32.00	8.00	X	•	•	X	•	•	•	•	•	•	•
S018035060	18.00	35.00	6.00	X	•	•	•	•	•	•	•	•	•	•
S018035070	18.00	35.00	7.00	X	•	•	X	•	•	•	•	•	•	•
S018035080	18.00	35.00	8.00	X	•	•	•	•	•	•	•	•	•	•
S018035100	18.00	35.00	10.00	X	•	•	•	•	•	•	•	•	•	•
S018040070	18.00	40.00	7.00	X	•	•	•	•	•	•	•	•	•	•
S018040100	18.00	40.00	10.00	X	•	•	•	•	•	•	•	•	•	•
S018042080	18.00	42.00	8.00	X	•	•	•	•	•	•	•	•	•	•
S019027060	19.00	27.00	6.00	X	•	•	•	•	•	•	•	•	•	•
S019030070	19.00	30.00	7.00	X	•	•	X	•	•	•	•	•	•	•
S019032060	19.00	32.00	6.00	X	•	•	•	•	•	•	•	•	•	•
S019032070	19.00	32.00	7.00	X	•	•	•	•	•	•	•	•	•	•
S019032100	19.00	32.00	10.00	•	•	•	X	•	•	•	•	•	•	•
S019034060	19.00	34.00	6.00	X	•	•	•	•	•	•	•	•	•	•
S019035080	19.00	35.00	8.00	X	•	•	•	•	•	•	•	•	•	•
S019035100	19.00	35.00	10.00	X	•	•	•	•	•	•	•	•	•	•
S019037100	19.00	37.00	10.00	X	•	•	•	•	•	•	•	•	•	•
S019040100	19.00	40.00	10.00	X	•	•	•	•	•	•	•	•	•	•
S020026040	20.00	26.00	4.00	•	•	•	•	•	•	•	X	•	•	•
S020028040	20.00	28.00	4.00	•	•	•	•	•	•	•	X	•	•	•
S020028060	20.00	28.00	6.00	X	•	•	•	•	•	•	•	•	•	•
S020028070	20.00	28.00	7.00	X	•	•	•	•	•	•	•	•	•	•
S020030045	20.00	30.00	4.50	X	•	•	•	•	•	•	•	•	•	•
S020030046	20.00	30.00	4.60	X	•	•	•	•	•	•	•	•	•	•
S020030050	20.00	30.00	5.00	X	•	•	•	•	•	•	•	•	•	•
S020030070	20.00	30.00	7.00	X	•	•	X	•	•	•	•	•	•	•
S020030080	20.00	30.00	8.00	X	•	•	•	•	•	•	•	•	•	•

X: EXISTING TOOLING •: ON REQUEST

N.B.: MINIMUM LINE ORDER MAY APPLY



## GLOBAL AVAILABILITY LIST

## RADIAL SHAFT SEALS - FPM/STEEL

METRIC SIZE  
SHAFT SEALS

SC/V 	Ref. Number	Dimensions			DESIGN TYPE										
		d	D	H	SC/V	SB2/V	SA2/V	TC/V	TB2/V	TA2/V	VB/V	VC/V	KB/V	KC/V	
	S020032050	20.00	32.00	5.00	X	.	.	.	.	.	.	.	.	.	.
	S020032060	20.00	32.00	6.00	X	.	.	.	.	.	.	.	.	.	.
	S020032070	20.00	32.00	7.00	X	.	.	X	.	.	.	.	.	.	.
	S020033100	20.00	33.00	10.00	X	.	.	.	.	.	.	.	.	.	.
	S020035050	20.00	35.00	5.00	X	.	.	.	.	.	.	.	.	.	.
	S020035060	20.00	35.00	6.00	X	.	.	.	.	.	.	.	.	.	.
	S020035070	20.00	35.00	7.00	X	.	.	X	.	.	.	.	.	.	.
	S020035080	20.00	35.00	8.00	X	.	.	.	.	.	.	.	.	.	.
	S020035100	20.00	35.00	10.00	X	.	.	.	.	.	.	.	.	.	.
	S020036070	20.00	36.00	7.00	X	.	.	.	.	.	.	.	.	.	.
	S020037080	20.00	37.00	8.00	X	.	.	.	.	.	.	.	.	.	.
	S020037100	20.00	37.00	10.00	X	.	.	.	.	.	.	.	.	.	.
	S020038070	20.00	38.00	7.00	X	.	.	.	.	.	.	.	.	.	.
	S020038080	20.00	38.00	8.00	X	.	.	.	.	.	.	.	.	.	.
	S020040060	20.00	40.00	6.00	X	.	.	.	.	.	.	.	.	.	.
	S020040070	20.00	40.00	7.00	X	.	.	X	.	.	.	.	.	.	.
	S020040080	20.00	40.00	8.00	.	.	.	.	.	.	.	.	.	.	.
	S020040085	20.00	40.00	8.50	X	.	.	.	.	.	.	.	.	.	.
	S020040100	20.00	40.00	10.00	X	.	.	.	.	.	.	.	.	.	.
	S020042060	20.00	42.00	6.00	X	.	.	.	.	.	.	.	.	.	.
	S020042070	20.00	42.00	7.00	X	.	.	X	.	.	.	.	.	.	.
	S020043075	20.00	43.00	7.50	X	.	.	.	.	.	.	.	.	.	.
	S020042100	20.00	42.00	10.00	X	.	.	.	.	.	.	.	.	.	.
	S020045100	20.00	45.00	10.00	X	.	.	.	.	.	.	.	.	.	.
	S020047070	20.00	47.00	7.00	X	.	.	X	.	.	.	.	.	.	.
	S020047080	20.00	47.00	8.00	X	.	.	.	.	.	.	.	.	.	.
	S020047100	20.00	47.00	10.00	X	.	.	.	.	.	.	.	.	.	.
	S020048090	20.00	48.00	9.00	X	.	.	.	.	.	.	.	.	.	.
	S020052070	20.00	52.00	7.00	X	.	.	.	.	.	.	.	.	.	.
	S020052100	20.00	52.00	10.00	X	.	.	.	.	.	.	.	.	.	.
	S021030065	21.00	30.00	6.50	X	.	.	.	.	.	.	.	.	.	.
	S022030040	22.00	30.00	4.00	.	.	.	.	.	.	.	X	.	.	.
	S022030070	22.00	30.00	7.00	X	.	.	.	.	.	.	.	.	.	.
	S022032055	22.00	32.00	5.50	X	.	.	.	.	.	.	.	.	.	.
	S022032056	22.00	32.00	5.60	X	.	.	.	.	.	.	.	.	.	.
	S022032070	22.00	32.00	7.00	X	.	.	X	.	.	.	.	.	.	.
	S022032080	22.00	32.00	8.00	.	.	.	.	.	.	.	.	.	.	.
	S022032100	22.00	32.00	10.00	X	.	.	.	.	.	.	.	.	.	.
	S022035060	22.00	35.00	6.00	X	.	.	.	.	.	.	.	.	.	.
	S022035070	22.00	35.00	7.00	X	.	.	X	.	.	.	.	.	.	.
	S022035080	22.00	35.00	8.00	X	.	.	.	.	.	.	.	.	.	.
	S022035100	22.00	35.00	10.00	X	.	.	.	.	.	.	.	.	.	.
	S022035055	22.00	35.00	5.50	X	.	.	.	.	.	.	.	.	.	.
	S022035056	22.00	35.00	6.50	X	.	.	.	.	.	.	.	.	.	.
	S022037070	22.00	37.00	7.00	X	.	.	.	.	.	.	.	.	.	.
	S022038070	22.00	38.00	7.00	X	.	.	.	.	.	.	.	.	.	.
	S022038080	22.00	38.00	8.00	X	.	.	.	.	.	.	.	.	.	.

X: EXISTING TOOLING    .: ON REQUEST

N.B.: MINIMUM LINE ORDER MAY APPLY

Tel.: (514) 334-2220  
Fax: (514) 333-8329

**SS 231**

[www.sealsonline.com](http://www.sealsonline.com)





## RADIAL SHAFT SEALS - FPM/STEEL

## GLOBAL AVAILABILITY LIST

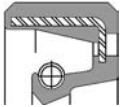
Ref. Number	Dimensions			DESIGN TYPE										SC/V 
	d	D	H	SC/V	SB2/V	SA2/V	TC/V	TB2/V	TA2/V	VB/V	VC/V	KB/V	KC/V	
S022040050	22.00	40.00	5.00	X	•	•	•	•	•	•	•	•	•	
S022040070	22.00	40.00	7.00	X	•	•	X	•	•	•	•	•	•	
S022040080	22.00	40.00	8.00	X	•	•	•	•	•	•	•	•	•	
S022040085	22.00	40.00	8.50	X	•	•	•	•	•	•	•	•	•	
S022040100	22.00	40.00	10.00	X	•	•	•	•	•	•	•	•	•	
S022042070	22.00	42.00	7.00	X	•	•	•	•	•	•	•	•	•	
S022042100	22.00	42.00	10.00	X	•	•	•	•	•	•	•	•	•	
S022045070	22.00	45.00	7.00	X	•	•	•	•	•	•	•	•	•	
S022047070	22.00	47.00	7.00	X	•	•	•	•	•	•	•	•	•	
S022047100	22.00	47.00	10.00	X	•	•	•	•	•	•	•	•	•	
S022052100	22.00	52.00	10.00	•	•	•	X	•	•	•	•	•	•	
S023037050	23.00	37.00	5.00	X	•	•	•	•	•	•	•	•	•	
S023038070	23.00	38.00	7.00	X	•	•	•	•	•	•	•	•	•	
S023038080	23.00	38.00	8.00	X	•	•	•	•	•	•	•	•	•	
S023040100	23.00	40.00	10.00	X	•	•	•	•	•	•	•	•	•	
S023052120	23.00	52.00	12.00	X	•	•	•	•	•	•	•	•	•	
S024035060	24.00	35.00	6.00	X	•	•	•	•	•	•	•	•	•	
S024035070	24.00	35.00	7.00	X	•	•	•	•	•	•	•	•	•	
S024036070	24.00	36.00	7.00	X	•	•	X	•	•	•	•	•	•	
S024037070	24.00	37.00	7.00	X	•	•	•	•	•	•	•	•	•	
S024038100	24.00	38.00	10.00	X	•	•	•	•	•	•	•	•	•	
S024040070	24.00	40.00	7.00	X	•	•	X	•	•	•	•	•	•	
S024040100	24.00	40.00	10.00	X	•	•	•	•	•	•	•	•	•	
S024042070	24.00	42.00	7.00	X	•	•	•	•	•	•	•	•	•	
S024042080	24.00	42.00	8.00	X	•	•	•	•	•	•	•	•	•	
S024042100	24.00	42.00	10.00	X	•	•	•	•	•	•	•	•	•	
S024045070	24.00	45.00	7.00	X	•	•	•	•	•	•	•	•	•	
S024047070	24.00	47.00	7.00	X	•	•	•	•	•	•	•	•	•	
S024047100	24.00	47.00	10.00	X	•	•	•	•	•	•	•	•	•	
S024052100	24.00	52.00	10.00	X	•	•	•	•	•	•	•	•	•	
S025032040	25.00	32.00	4.00	•	•	•	•	•	•	•	X	•	•	
S025032060	25.00	32.00	6.00	X	•	•	X	•	•	•	•	•	•	
S025032070	25.00	32.00	7.00	X	•	•	•	•	•	•	•	•	•	
S025033060	25.00	33.00	6.00	X	•	•	•	•	•	•	•	•	•	
S025035040	25.00	35.00	4.00	•	•	•	•	•	•	•	X	•	•	
S025035050	25.00	35.00	5.00	X	•	•	X	•	•	•	•	•	•	
S025035070	25.00	35.00	7.00	X	•	•	X	•	•	•	•	•	•	
S025035080	25.00	35.00	8.00	X	•	•	•	•	•	•	•	•	•	
S025035100	25.00	35.00	10.00	X	•	•	•	•	•	•	•	•	•	
S025036070	25.00	36.00	7.00	X	•	•	•	•	•	•	•	•	•	
S025037060	25.00	37.00	6.00	X	•	•	•	•	•	•	•	•	•	
S025037070	25.00	37.00	7.00	X	•	•	•	•	•	•	•	•	•	
S025038070	25.00	38.00	7.00	X	•	•	•	•	•	•	•	•	•	
S025038080	25.00	38.00	8.00	•	•	•	•	•	•	•	•	•	•	
S025040050	25.00	40.00	5.00	X	•	•	•	•	•	•	•	•	•	
S025040070	25.00	40.00	7.00	X	•	•	X	•	•	•	•	•	•	
S025040080	25.00	40.00	8.00	X	•	•	X	•	•	•	•	•	•	
S025040100	25.00	40.00	10.00	X	•	•	•	•	•	•	•	•	•	

X: EXISTING TOOLING •: ON REQUEST













N.B.: MINIMUM LINE ORDER MAY APPLY

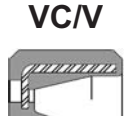
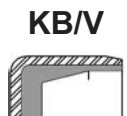
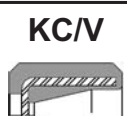

## GLOBAL AVAILABILITY LIST

## RADIAL SHAFT SEALS - FPM/STEEL

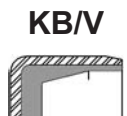
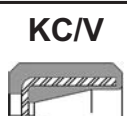
METRIC SIZE  
SHAFT SEALS

SC/V 	Ref. Number	Dimensions			DESIGN TYPE									
		d	D	H	SC/V	SB2/V	SA2/V	TC/V	TB2/V	TA2/V	VB/V	VC/V	KB/V	KC/V
	S025042060	25.00	42.00	6.00	X	•	•	•	•	•	•	•	•	•
	S025042070	25.00	42.00	7.00	X	•	•	X	•	•	•	•	•	•
	S025042080	25.00	42.00	8.00	X	•	•	X	•	•	•	•	•	•
	S025042085	25.00	42.00	8.50	X	•	•	•	•	•	•	•	•	•
	S025042100	25.00	42.00	10.00	X	•	•	•	•	•	•	•	•	•
	S025043090	25.00	43.00	9.00	X	•	•	•	•	•	•	•	•	•
	S025043100	25.00	43.00	10.00	X	•	•	•	•	•	•	•	•	•
	S025045070	25.00	45.00	7.00	X	•	•	•	•	•	•	•	•	•
	S025045100	25.00	45.00	10.00	X	•	•	X	•	•	•	•	•	•
	S025045140	25.00	45.00	14.00	•	•	•	•	•	•	•	•	•	•
	S025046070	25.00	46.00	7.00	X	•	•	•	•	•	•	•	•	•
	S025047070	25.00	47.00	7.00	X	•	•	X	•	•	•	•	•	•
	S025047080	25.00	47.00	8.00	X	•	•	•	•	•	•	•	•	•
	S025047100	25.00	47.00	10.00	X	•	•	•	•	•	•	•	•	•
	S025050070	25.00	50.00	7.00	X	•	•	•	•	•	•	•	•	•
	S025050100	25.00	50.00	10.00	X	•	•	•	•	•	•	•	•	•
	S025050120	25.00	50.00	12.00	X	•	•	•	•	•	•	•	•	•
	S025051110	25.00	51.00	11.00	X	•	•	•	•	•	•	•	•	•
	S025052070	25.00	52.00	7.00	X	•	•	X	•	•	•	•	•	•
	S025052080	25.00	52.00	8.00	X	•	•	•	•	•	•	•	•	•
	S025052100	25.00	52.00	10.00	X	•	•	•	•	•	•	•	•	•
	S025052120	25.00	52.00	12.00	X	•	•	•	•	•	•	•	•	•
	S025055100	25.00	55.00	10.00	X	•	•	•	•	•	•	•	•	•
	S025062070	25.00	62.00	7.00	X	•	•	X	•	•	•	•	•	•
	S025062080	25.00	62.00	8.00	X	•	•	•	•	•	•	•	•	•
	S025062100	25.00	62.00	10.00	X	•	•	•	•	•	•	•	•	•
	S025072070	25.00	72.00	7.00	X	•	•	•	•	•	•	•	•	•
	S026034040	26.00	34.00	4.00	X	•	•	•	•	•	•	•	•	•
	S026035070	26.00	35.00	7.00	X	•	•	•	•	•	•	•	•	•
	S026036070	26.00	36.00	7.00	X	•	•	•	•	•	•	•	•	•
	S026037070	26.00	37.00	7.00	X	•	•	X	•	•	•	•	•	•
	S026037100	26.00	37.00	10.00	X	•	•	•	•	•	•	•	•	•
	S026037105	26.00	37.00	10.50	•	•	•	•	•	•	•	•	•	•
	S026040070	26.00	40.00	7.00	X	•	•	X	•	•	•	•	•	•
	S026042060	26.00	42.00	6.00	X	•	•	•	•	•	•	•	•	•
	S026042070	26.00	42.00	7.00	X	•	•	X	•	•	•	•	•	•
	S026047070	26.00	47.00	7.00	X	•	•	•	•	•	•	•	•	•
	S026047100	26.00	47.00	10.00	X	•	•	•	•	•	•	•	•	•
	S026052080	26.00	52.00	8.00	X	•	•	•	•	•	•	•	•	•
	S026052100	26.00	52.00	10.00	•	•	•	X	•	•	•	•	•	•
	S027035040	27.00	35.00	4.00	X	•	•	•	•	•	•	•	•	•
	S027035070	27.00	35.00	7.00	X	•	•	•	•	•	•	•	•	•
	S027037070	27.00	37.00	7.00	X	•	•	•	•	•	•	•	•	•
	S027041100	27.00	41.00	10.00	X	•	•	•	•	•	•	•	•	•
	S027042070	27.00	42.00	7.00	X	•	•	•	•	•	•	•	•	•
	S027042100	27.00	42.00	10.00	X	•	•	X	•	•	•	•	•	•
	S027047060	27.00	47.00	6.00	X	•	•	•	•	•	•	•	•	•
	S027047080	27.00	47.00	8.00	X	•	•	•	•	•	•	•	•	•

X: EXISTING TOOLING    •: ON REQUEST

N.B.: MINIMUM LINE ORDER MAY APPLY

Tel.: (888) 238-5885  
Fax: (888) 238-1664



www.sealsonline.com



## RADIAL SHAFT SEALS - FPM/STEEL

## GLOBAL AVAILABILITY LIST

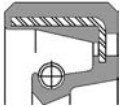
Ref. Number	Dimensions			DESIGN TYPE										SC/V 
	d	D	H	SC/V	SB2/V	SA2/V	TC/V	TB2/V	TA2/V	VB/V	VC/V	KB/V	KC/V	
S027047098	27.00	47.00	9.80	X	•	•	•	•	•	•	•	•	•	•
S027047100	27.00	47.00	10.00	X	•	•	•	•	•	•	•	•	•	•
S027050100	27.00	50.00	10.00	X	•	•	•	•	•	•	•	•	•	•
S027052080	27.00	52.00	8.00	X	•	•	•	•	•	•	•	•	•	•
S028035040	28.00	35.00	4.00	•	•	•	•	•	•	•	X	•	•	•
S028038055	28.00	38.00	5.50	X	•	•	•	•	•	•	•	•	•	•
S028038060	28.00	38.00	6.00	X	•	•	•	•	•	•	•	•	•	•
S028038070	28.00	38.00	7.00	X	•	•	X	•	•	•	•	•	•	•
S028040050	28.00	40.00	5.00	X	•	•	•	•	•	•	•	•	•	•
S028040070	28.00	40.00	7.00	X	•	•	•	•	•	•	•	•	•	•
S028040080	28.00	40.00	8.00	X	•	•	•	•	•	•	•	•	•	•
S028040100	28.00	40.00	10.00	X	•	•	•	•	•	•	•	•	•	•
S028042070	28.00	42.00	7.00	X	•	•	•	•	•	•	•	•	•	•
S028042080	28.00	42.00	8.00	X	•	•	•	•	•	•	•	•	•	•
S028042100	28.00	42.00	10.00	X	•	•	•	•	•	•	•	•	•	•
S028043090	28.00	43.00	9.00	X	•	•	•	•	•	•	•	•	•	•
S028043100	28.00	43.00	10.00	X	•	•	•	•	•	•	•	•	•	•
S028044100	28.00	44.00	10.00	X	•	•	•	•	•	•	•	•	•	•
S028045070	28.00	45.00	7.00	X	•	•	•	•	•	•	•	•	•	•
S028045080	28.00	45.00	8.00	X	•	•	•	•	•	•	•	•	•	•
S028045090	28.00	45.00	9.00	X	•	•	•	•	•	•	•	•	•	•
S028047070	28.00	47.00	7.00	X	•	•	X	•	•	•	•	•	•	•
S028047080	28.00	47.00	8.00	X	•	•	•	•	•	•	•	•	•	•
S028047100	28.00	47.00	10.00	X	•	•	X	•	•	•	•	•	•	•
S028050080	28.00	50.00	8.00	X	•	•	•	•	•	•	•	•	•	•
S028050100	28.00	50.00	10.00	X	•	•	•	•	•	•	•	•	•	•
S028052070	28.00	52.00	7.00	X	•	•	X	•	•	•	•	•	•	•
S028052100	28.00	52.00	10.00	X	•	•	•	•	•	•	•	•	•	•
S028052120	28.00	52.00	12.00	X	•	•	•	•	•	•	•	•	•	•
S028062100	28.00	62.00	10.00	X	•	•	•	•	•	•	•	•	•	•
S028062120	28.00	62.00	12.00	X	•	•	•	•	•	•	•	•	•	•
S029042070	29.00	42.00	7.00	X	•	•	•	•	•	•	•	•	•	•
S029045080	29.00	45.00	8.00	X	•	•	•	•	•	•	•	•	•	•
S029045095	29.00	45.00	9.50	X	•	•	•	•	•	•	•	•	•	•
S029047100	29.00	47.00	10.00	X	•	•	•	•	•	•	•	•	•	•
S029050100	29.00	50.00	10.00	X	•	•	•	•	•	•	•	•	•	•
S029052090	29.00	52.00	9.00	X	•	•	•	•	•	•	•	•	•	•
S029055090	29.00	55.00	9.00	X	•	•	•	•	•	•	•	•	•	•
S029062100	29.00	62.00	10.00	X	•	•	•	•	•	•	•	•	•	•
S030034030	30.00	34.00	3.00	•	•	•	•	•	•	X	•	•	•	•
S030037040	30.00	37.00	4.00	•	•	•	•	•	•	•	X	•	•	•
S030040040	30.00	40.00	4.00	•	•	•	•	•	•	•	X	•	•	•
S030040050	30.00	40.00	5.00	X	•	•	•	•	•	•	•	•	•	•
S030040070	30.00	40.00	7.00	X	•	•	X	•	•	•	•	•	•	•
S030040080	30.00	40.00	8.00	X	•	•	•	•	•	•	•	•	•	•
S030040090	30.00	40.00	9.00	X	•	•	•	•	•	•	•	•	•	•
S030040100	30.00	40.00	10.00	X	•	•	•	•	•	•	•	•	•	•
S030042060	30.00	42.00	6.00	X	•	•	X	•	•	•	•	•	•	•

X: EXISTING TOOLING •: ON REQUEST









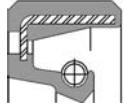

N.B.: MINIMUM LINE ORDER MAY APPLY



## GLOBAL AVAILABILITY LIST

## RADIAL SHAFT SEALS - FPM/STEEL

**METRIC SIZE  
SHAFT SEALS**

SC/V 	Ref. Number	Dimensions			DESIGN TYPE									
		d	D	H	SC/V	SB2/V	SA2/V	TC/V	TB2/V	TA2/V	VB/V	VC/V	KB/V	KC/V
	S030042070	30.00	42.00	7.00	X	.	.	X	.	.	.	.	.	.
	S030042080	30.00	42.00	8.00	X	.	.	X	.	.	.	.	.	.
	S030042100	30.00	42.00	10.00	X	.	.	.	.	.	.	.	.	.
SB2/V 	S030043080	30.00	43.00	8.00	X	.	.	.	.	.	.	.	.	.
	S030044100	30.00	44.00	10.00	X	.	.	.	.	.	.	.	.	.
	S030045050	30.00	45.00	5.00	X	.	.	.	.	.	.	.	.	.
	S030045060	30.00	45.00	6.00	X	.	.	.	.	.	.	.	.	.
	S030045070	30.00	45.00	7.00	X	.	.	X	.	.	.	.	.	.
SA2/V 	S030045080	30.00	45.00	8.00	X	.	.	X	.	.	.	.	.	.
	S030045085	30.00	45.00	8.50	.	.	.	.	.	.	.	.	.	.
	S030045100	30.00	45.00	10.00	X	.	.	.	.	.	.	.	.	.
	S030045120	30.00	45.00	12.00	.	.	.	.	.	.	.	.	.	.
	S030046100	30.00	46.00	10.00	X	.	.	.	.	.	.	.	.	.
TC/V 	S030047060	30.00	47.00	6.00	X	.	.	.	.	.	.	.	.	.
	S030047070	30.00	47.00	7.00	X	.	.	X	.	.	.	.	.	.
	S030047080	30.00	47.00	8.00	X	.	.	.	.	.	.	.	.	.
	S030047100	30.00	47.00	10.00	X	.	.	.	.	.	.	.	.	.
	S030047140	30.00	47.00	14.00	.	.	.	.	.	.	.	.	.	.
TB2/V 	S030048080	30.00	48.00	8.00	X	.	.	.	.	.	.	.	.	.
	S030048100	30.00	48.00	10.00	X	.	.	.	.	.	.	.	.	.
	S030050070	30.00	50.00	7.00	X	.	.	.	.	.	.	.	.	.
	S030050080	30.00	50.00	8.00	X	.	.	.	.	.	.	.	.	.
	S030050100	30.00	50.00	10.00	X	.	.	.	.	.	.	.	.	.
TA2/V 	S030051100	30.00	51.00	10.00	.	.	.	.	.	.	.	.	.	.
	S030052050	30.00	52.00	5.00	X	.	.	.	.	.	.	.	.	.
	S030052060	30.00	52.00	6.00	X	.	.	.	.	.	.	.	.	.
	S030052070	30.00	52.00	7.00	X	.	.	X	.	.	.	.	.	.
	S030052080	30.00	52.00	8.00	X	.	.	.	.	.	.	.	.	.
VB/V 	S030052100	30.00	52.00	10.00	X	.	.	X	.	.	.	.	.	.
	S030052120	30.00	52.00	12.00	X	.	.	.	.	.	.	.	.	.
	S030054100	30.00	54.00	10.00	X	.	.	.	.	.	.	.	.	.
	S030055060	30.00	55.00	6.00	X	.	.	.	.	.	.	.	.	.
	S030055070	30.00	55.00	7.00	X	.	.	X	.	.	.	.	.	.
VC/V 	S030055100	30.00	55.00	10.00	X	.	.	X	.	.	.	.	.	.
	S030055120	30.00	55.00	12.00	X	.	.	.	.	.	.	.	.	.
	S030056080	30.00	56.00	8.00	X	.	.	.	.	.	.	.	.	.
	S030056100	30.00	56.00	10.00	X	.	.	.	.	.	.	.	.	.
	S030056120	30.00	56.00	12.00	X	.	.	.	.	.	.	.	.	.
KB/V 	S030057080	30.00	57.00	8.00	X	.	.	.	.	.	.	.	.	.
	S030060100	30.00	60.00	10.00	X	.	.	.	.	.	.	.	.	.
	S030062070	30.00	62.00	7.00	X	.	.	X	.	.	.	.	.	.
	S030062080	30.00	62.00	8.00	X	.	.	X	.	.	.	.	.	.
	S030062100	30.00	62.00	10.00	X	.	.	.	.	.	.	.	.	.
KC/V 	S030062120	30.00	62.00	12.00	X	.	.	.	.	.	.	.	.	.
	S030062140	30.00	62.00	14.00	.	.	.	.	.	.	.	.	.	.
	S030065100	30.00	65.00	10.00	X	.	.	.	.	.	.	.	.	.
	S030072080	30.00	72.00	8.00	.	.	.	X	.	.	.	.	.	.
	S030072100	30.00	72.00	10.00	X	.	.	.	.	.	.	.	.	.

X: EXISTING TOOLING    \*: ON REQUEST

N.B.: MINIMUM LINE ORDER MAY APPLY

**Tel.: (204) 783-9617**  
**Fax: (204) 783-6091**

**SS 235**

[www.sealsonline.com](http://www.sealsonline.com)



**M**

## RADIAL SHAFT SEALS - FPM/STEEL

## GLOBAL AVAILABILITY LIST

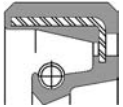
Ref. Number	Dimensions			DESIGN TYPE										SC/V 
	d	D	H	SC/V	SB2/V	SA2/V	TC/V	TB2/V	TA2/V	VB/V	VC/V	KB/V	KC/V	
S031047070	31.00	47.00	7.00	X	.	.	.	.	.	.	.	.	.	.
S031047100	31.00	47.00	10.00	X	.	.	.	.	.	.	.	.	.	.
S031052060	31.00	52.00	6.00	X	.	.	.	.	.	.	.	.	.	.
S031052070	31.00	52.00	7.00	X	.	.	.	.	.	.	.	.	.	.
S031052090	31.00	52.00	9.00	X	.	.	.	.	.	.	.	.	.	.
S031055090	31.00	55.00	9.00	X	.	.	.	.	.	.	.	.	.	.
S032040070	32.00	40.00	7.00	.	.	.	X	.	.	.	.	.	.	.
S032042070	32.00	42.00	7.00	X	.	.	.	.	.	.	.	.	.	.
S032044080	32.00	44.00	8.00	.	.	.	.	.	.	.	.	.	.	.
S032045060	32.00	45.00	6.00	X	.	.	.	.	.	.	.	.	.	.
S032045070	32.00	45.00	7.00	X	.	.	.	.	.	.	.	.	.	.
S032045080	32.00	45.00	8.00	X	.	.	.	.	.	.	.	.	.	.
S032045100	32.00	45.00	10.00	X	.	.	.	.	.	.	.	.	.	.
S032047060	32.00	47.00	6.00	X	.	.	.	.	.	.	.	.	.	.
S032047070	32.00	47.00	7.00	X	.	.	X	.	.	.	.	.	.	.
S032047080	32.00	47.00	8.00	X	.	.	.	.	.	.	.	.	.	.
S032047100	32.00	47.00	10.00	X	.	.	.	.	.	.	.	.	.	.
S032048070	32.00	48.00	7.00	X	.	.	.	.	.	.	.	.	.	.
S032048080	32.00	48.00	8.00	X	.	.	X	.	.	.	.	.	.	.
S032050070	32.00	50.00	7.00	X	.	.	.	.	.	.	.	.	.	.
S032050080	32.00	50.00	8.00	X	.	.	.	.	.	.	.	.	.	.
S032050100	32.00	50.00	10.00	X	.	.	X	.	.	.	.	.	.	.
S032050120	32.00	50.00	12.00	X	.	.	.	.	.	.	.	.	.	.
S032052070	32.00	52.00	7.00	X	.	.	.	.	.	.	.	.	.	.
S032052075	32.00	52.00	7.50	X	.	.	.	.	.	.	.	.	.	.
S032052080	32.00	52.00	8.00	X	.	.	.	.	.	.	.	.	.	.
S032052100	32.00	52.00	10.00	X	.	.	.	.	.	.	.	.	.	.
S032052120	32.00	52.00	12.00	X	.	.	.	.	.	.	.	.	.	.
S032055100	32.00	55.00	10.00	X	.	.	.	.	.	.	.	.	.	.
S032056100	32.00	56.00	10.00	X	.	.	X	.	.	.	.	.	.	.
S032057095	32.00	57.00	9.50	X	.	.	.	.	.	.	.	.	.	.
S032062080	32.00	62.00	8.00	X	.	.	.	.	.	.	.	.	.	.
S032062100	32.00	62.00	10.00	X	.	.	.	.	.	.	.	.	.	.
S032065130	32.00	65.00	13.00	.	.	.	X	.	.	.	.	.	.	.
S032066100	32.00	66.00	10.00	X	.	.	.	.	.	.	.	.	.	.
S032070080	32.00	70.00	8.00	X	.	.	.	.	.	.	.	.	.	.
S033043070	33.00	43.00	7.00	X	.	.	.	.	.	.	.	.	.	.
S033045070	33.00	45.00	7.00	X	.	.	.	.	.	.	.	.	.	.
S033048120	33.00	48.00	12.00	X	.	.	.	.	.	.	.	.	.	.
S033050060	33.00	50.00	6.00	X	.	.	.	.	.	.	.	.	.	.
S033050080	33.00	50.00	8.00	X	.	.	.	.	.	.	.	.	.	.
S033050100	33.00	50.00	10.00	X	.	.	.	.	.	.	.	.	.	.
S033052060	33.00	52.00	6.00	X	.	.	.	.	.	.	.	.	.	.
S033052080	33.00	52.00	8.00	X	.	.	.	.	.	.	.	.	.	.
S033052100	33.00	52.00	10.00	X	.	.	.	.	.	.	.	.	.	.
S033056120	33.00	56.00	12.00	X	.	.	.	.	.	.	.	.	.	.
S034044070	34.00	44.00	7.00	X	.	.	.	.	.	.	.	.	.	.
S034045070	34.00	45.00	7.00	X	.	.	.	.	.	.	.	.	.	.

X: EXISTING TOOLING    •: ON REQUEST

N.B.: MINIMUM LINE ORDER MAY APPLY



## GLOBAL AVAILABILITY LIST

## RADIAL SHAFT SEALS - FPM/STEEL

METRIC SIZE  
SHAFT SEALS

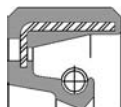
SC/V 	Ref. Number	Dimensions			DESIGN TYPE									
		d	D	H	SC/V	SB2/V	SA2/V	TC/V	TB2/V	TA2/V	VB/V	VC/V	KB/V	KC/V
	S034046100	34.00	46.00	10.00	X	.	.	.	.	.	.	.	.	.
	S034049080	34.00	49.00	8.00	X	.	.	.	.	.	.	.	.	.
	S034050080	34.00	50.00	8.00	X	.	.	.	.	.	.	.	.	.
	S034050100	34.00	50.00	10.00	X	.	.	.	.	.	.	.	.	.
	S034052075	34.00	52.00	7.50	X	.	.	.	.	.	.	.	.	.
	S034052080	34.00	52.00	8.00	X	.	.	.	.	.	.	.	.	.
	S034052100	34.00	52.00	10.00	X	.	.	.	.	.	.	.	.	.
	S034055070	34.00	55.00	7.00	X	.	.	.	.	.	.	.	.	.
	S034055090	34.00	55.00	9.00	X	.	.	.	.	.	.	.	.	.
	S034055100	34.00	55.00	10.00	X	.	.	.	.	.	.	.	.	.
	S034058130	34.00	58.00	13.00	X	.	.	.	.	.	.	.	.	.
	S034062100	34.00	62.00	10.00	X	.	.	.	.	.	.	.	.	.
	S034072145	34.00	72.00	14.50	.	.	.	X	.	.	.	.	.	.
	S035042040	35.00	42.00	4.00	.	.	.	.	.	.	X	.	.	.
	S035044070	35.00	44.00	7.00	X	.	.	.	.	.	.	.	.	.
	S035045040	35.00	45.00	4.00	.	.	.	.	.	.	X	.	.	.
	S035045050	35.00	45.00	5.00	.	.	.	.	.	X	.	.	.	.
	S035045070	35.00	45.00	7.00	X	.	.	.	.	.	.	.	.	.
	S035045100	35.00	45.00	10.00	X	.	.	.	.	.	.	.	.	.
	S035047050	35.00	47.00	5.00	X	.	.	.	.	.	.	.	.	.
	S035047060	35.00	47.00	6.00	X	.	.	.	.	.	.	.	.	.
	S035047070	35.00	47.00	7.00	X	.	.	X	.	.	.	.	.	.
	S035047100	35.00	47.00	10.00	X	.	.	.	.	.	.	.	.	.
	S035048070	35.00	48.00	7.00	X	.	.	X	.	.	.	.	.	.
	S035048080	35.00	48.00	8.00	X	.	.	.	.	.	.	.	.	.
	S035048090	35.00	48.00	9.00	X	.	.	.	.	.	.	.	.	.
	S035050070	35.00	50.00	7.00	X	.	.	X	.	.	.	.	.	.
	S035050080	35.00	50.00	8.00	X	.	.	X	.	.	.	.	.	.
	S035050100	35.00	50.00	10.00	X	.	.	X	.	.	.	.	.	.
	S035052055	35.00	52.00	5.50	.	.	.	X	.	.	.	.	.	.
	S035052060	35.00	52.00	6.00	.	.	.	X	.	.	.	.	.	.
	S035052070	35.00	52.00	7.00	X	.	.	X	.	.	.	.	.	.
	S035052080	35.00	52.00	8.00	X	.	.	.	.	.	.	.	.	.
	S035052088	35.00	52.00	8.80	X	.	.	.	.	.	.	.	.	.
	S035052100	35.00	52.00	10.00	X	.	.	X	.	.	.	.	.	.
	S035052120	35.00	52.00	12.00	X	.	.	.	.	.	.	.	.	.
	S035053090	35.00	53.00	9.00	X	.	.	.	.	.	.	.	.	.
	S035054080	35.00	54.00	8.00	X	.	.	.	.	.	.	.	.	.
	S035054100	35.00	54.00	10.00	X	.	.	.	.	.	.	.	.	.
	S035055070	35.00	55.00	7.00	.	.	.	X	.	.	.	.	.	.
	S035055080	35.00	55.00	8.00	X	.	.	.	.	.	.	.	.	.
	S035055100	35.00	55.00	10.00	X	.	.	X	.	.	.	.	.	.
	S035055110	35.00	55.00	11.00	.	.	.	X	.	.	.	.	.	.
	S035055120	35.00	55.00	12.00	X	.	.	.	.	.	.	.	.	.
	S035056080	35.00	56.00	8.00	X	.	.	.	.	.	.	.	.	.
	S035056100	35.00	56.00	10.00	X	.	.	.	.	.	.	.	.	.
	S035056120	35.00	56.00	12.00	X	.	.	X	.	.	.	.	.	.
	S035058075	35.00	58.00	7.50	X	.	.	.	.	.	.	.	.	.

X: EXISTING TOOLING    .: ON REQUEST

N.B.: MINIMUM LINE ORDER MAY APPLY

Tel.: (780) 414-1871  
Fax: (780) 487-5419

**SS 237**

[www.sealsonline.com](http://www.sealsonline.com)



## RADIAL SHAFT SEALS - FPM/STEEL

## GLOBAL AVAILABILITY LIST

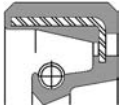
Ref. Number	Dimensions			DESIGN TYPE										SC/V 
	d	D	H	SC/V	SB2/V	SA2/V	TC/V	TB2/V	TA2/V	VB/V	VC/V	KB/V	KC/V	
S035058100	35.00	58.00	10.00	X	•	•	•	•	•	•	•	•	•	
S035058120	35.00	58.00	12.00	X	•	•	•	•	•	•	•	•	•	
S035060100	35.00	60.00	10.00	X	•	•	•	•	•	•	•	•	•	
S035060120	35.00	60.00	12.00	X	•	•	•	•	•	•	•	•	•	
S035062070	35.00	62.00	7.00	X	•	•	X	•	•	•	•	•	•	
S035062080	35.00	62.00	8.00	•	•	•	X	•	•	•	•	•	•	
S035062100	35.00	62.00	10.00	X	•	•	X	•	•	•	•	•	•	
S035062120	35.00	62.00	12.00	X	•	•	X	•	•	•	•	•	•	
S035062140	35.00	62.00	14.00	•	•	•	•	•	•	•	•	•	•	
S035065090	35.00	65.00	9.00	X	•	•	•	•	•	•	•	•	•	
S035065100	35.00	65.00	10.00	X	•	•	•	•	•	•	•	•	•	
S035065120	35.00	65.00	12.00	X	•	•	•	•	•	•	•	•	•	
S035068060	35.00	68.00	6.00	X	•	•	•	•	•	•	•	•	•	
S035068100	35.00	68.00	10.00	X	•	•	•	•	•	•	•	•	•	
S035068120	35.00	68.00	12.00	X	•	•	•	•	•	•	•	•	•	
S035072070	35.00	72.00	7.00	X	•	•	•	•	•	•	•	•	•	
S035072100	35.00	72.00	10.00	X	•	•	X	•	•	•	•	•	•	
S035072120	35.00	72.00	12.00	X	•	•	X	•	•	•	•	•	•	
S035080100	35.00	80.00	10.00	X	•	•	•	•	•	•	•	•	•	
S035080120	35.00	80.00	12.00	X	•	•	•	•	•	•	•	•	•	
S036047070	36.00	47.00	7.00	X	•	•	•	•	•	•	•	•	•	
S036048100	36.00	48.00	10.00	X	•	•	•	•	•	•	•	•	•	
S036050070	36.00	50.00	7.00	X	•	•	X	•	•	•	•	•	•	
S036050100	36.00	50.00	10.00	X	•	•	•	•	•	•	•	•	•	
S036052060	36.00	52.00	6.00	•	•	•	X	•	•	•	•	•	•	
S036052070	36.00	52.00	7.00	X	•	•	X	•	•	•	•	•	•	
S036052090	36.00	52.00	9.00	•	•	•	X	•	•	•	•	•	•	
S036054076	36.00	54.00	7.60	X	•	•	•	•	•	•	•	•	•	
S036056100	36.00	56.00	10.00	X	•	•	•	•	•	•	•	•	•	
S036058100	36.00	58.00	10.00	X	•	•	•	•	•	•	•	•	•	
S036058120	36.00	58.00	12.00	X	•	•	•	•	•	•	•	•	•	
S036062070	36.00	62.00	7.00	X	•	•	X	•	•	•	•	•	•	
S036062100	36.00	62.00	10.00	X	•	•	•	•	•	•	•	•	•	
S036065100	36.00	65.00	10.00	X	•	•	•	•	•	•	•	•	•	
S036068100	36.00	68.00	10.00	X	•	•	•	•	•	•	•	•	•	
S036075120	36.00	75.00	12.00	X	•	•	•	•	•	•	•	•	•	
S037047040	37.00	47.00	4.00	•	•	•	•	•	•	•	X	•	•	
S037052080	37.00	52.00	8.00	X	•	•	•	•	•	•	•	•	•	
S037052100	37.00	52.00	10.00	X	•	•	•	•	•	•	•	•	•	
S037062080	37.00	62.00	8.00	X	•	•	•	•	•	•	•	•	•	
S037072120	37.00	72.00	12.00	X	•	•	•	•	•	•	•	•	•	
S038050070	38.00	50.00	7.00	X	•	•	•	•	•	•	•	•	•	
S038050080	38.00	50.00	8.00	X	•	•	•	•	•	•	•	•	•	
S038050100	38.00	50.00	10.00	X	•	•	•	•	•	•	•	•	•	
S038052070	38.00	52.00	7.00	X	•	•	X	•	•	•	•	•	•	
S038052080	38.00	52.00	8.00	X	•	•	•	•	•	•	•	•	•	
S038052100	38.00	52.00	10.00	X	•	•	•	•	•	•	•	•	•	
S038054065	38.00	54.00	6.50	X	•	•	•	•	•	•	•	•	•	

X: EXISTING TOOLING •: ON REQUEST















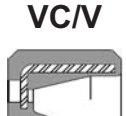

N.B.: MINIMUM LINE ORDER MAY APPLY

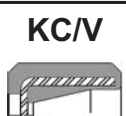

## GLOBAL AVAILABILITY LIST

## RADIAL SHAFT SEALS - FPM/STEEL

METRIC SIZE  
SHAFT SEALS

SC/V 	Ref. Number	Dimensions			DESIGN TYPE									
		d	D	H	SC/V	SB2/V	SA2/V	TC/V	TB2/V	TA2/V	VB/V	VC/V	KB/V	KC/V
	S038054100	38.00	54.00	10.00	X	.	.	.	.	.	.	.	.	.
	S038055060	38.00	55.00	6.00	X	.	.	.	.	.	.	.	.	.
	S038055070	38.00	55.00	7.00	X	.	.	.	.	.	.	.	.	.
	S038055100	38.00	55.00	10.00	X	.	.	X	.	.	.	.	.	.
	S038056100	38.00	56.00	10.00	X	.	.	.	.	.	.	.	.	.
	S038058100	38.00	58.00	10.00	X	.	.	.	.	.	.	.	.	.
	S038060070	38.00	60.00	7.00	X	.	.	.	.	.	.	.	.	.
	S038060100	38.00	60.00	10.00	X	.	.	.	.	.	.	.	.	.
	S038060120	38.00	60.00	12.00	X	.	.	.	.	.	.	.	.	.
	S038062070	38.00	62.00	7.00	X	.	.	X	.	.	.	.	.	.
	S038062080	38.00	62.00	8.00	X	.	.	.	.	.	.	.	.	.
	S038062100	38.00	62.00	10.00	X	.	.	X	.	.	.	.	.	.
	S038062120	38.00	62.00	12.00	X	.	.	.	.	.	.	.	.	.
	S038065080	38.00	65.00	8.00	X	.	.	.	.	.	.	.	.	.
	S038065100	38.00	65.00	10.00	X	.	.	.	.	.	.	.	.	.
	S038072100	38.00	72.00	10.00	X	.	.	.	.	.	.	.	.	.
	S038074100	38.00	74.00	10.00	X	.	.	.	.	.	.	.	.	.
	S039052100	39.00	52.00	10.00	.	.	.	X	.	.	.	.	.	.
	S039065090	39.00	65.00	9.00	X	.	.	.	.	.	.	.	.	.
	S040047040	40.00	47.00	4.00	.	.	.	.	.	.	.	X	.	.
	S040048040	40.00	48.00	4.00	.	.	.	.	.	.	.	.	X	.
	S040050070	40.00	50.00	7.00	X	.	.	.	.	.	.	.	.	.
	S040050080	40.00	50.00	8.00	X	.	.	.	.	.	.	.	.	.
	S040052050	40.00	52.00	5.00	X	.	.	.	.	.	.	.	.	.
	S040052060	40.00	52.00	6.00	X	.	.	.	.	.	.	.	.	.
	S040052070	40.00	52.00	7.00	X	.	.	X	.	.	.	.	.	.
	S040052080	40.00	52.00	8.00	X	.	.	.	.	.	.	.	.	.
	S040052090	40.00	52.00	9.00	.	.	.	X	.	.	.	.	.	.
	S040052100	40.00	52.00	10.00	X	.	.	.	.	.	.	.	.	.
	S040055060	40.00	55.00	6.00	.	.	.	X	.	.	.	.	.	.
	S040055070	40.00	55.00	7.00	X	.	.	X	.	.	.	.	.	.
	S040055080	40.00	55.00	8.00	X	.	.	X	.	.	.	.	.	.
	S040055100	40.00	55.00	10.00	X	.	.	.	.	.	.	.	.	.
	S040056070	40.00	56.00	7.00	X	.	.	.	.	.	.	.	.	.
	S040056080	40.00	56.00	8.00	X	.	.	.	.	.	.	.	.	.
	S040056100	40.00	56.00	10.00	X	.	.	.	.	.	.	.	.	.
	S040056120	40.00	56.00	12.00	X	.	.	.	.	.	.	.	.	.
	S040058070	40.00	58.00	7.00	X	.	.	.	.	.	.	.	.	.
	S040058080	40.00	58.00	8.00	X	.	.	X	.	.	.	.	.	.
	S040058090	40.00	58.00	9.00	X	.	.	.	.	.	.	.	.	.
	S040058100	40.00	58.00	10.00	X	.	.	.	.	.	.	.	.	.
	S040059095	40.00	59.00	9.50	.	.	.	X	.	.	.	.	.	.
	S040060070	40.00	60.00	7.00	X	.	.	.	.	.	.	.	.	.
	S040060080	40.00	60.00	8.00	X	.	.	.	.	.	.	.	.	.
	S040060100	40.00	60.00	10.00	X	.	.	X	.	.	.	.	.	.
	S040060120	40.00	60.00	12.00	X	.	.	.	.	.	.	.	.	.
	S040062070	40.00	62.00	7.00	X	.	.	X	.	.	.	.	.	.
	S040062080	40.00	62.00	8.00	X	.	.	.	.	.	.	.	.	.

X: EXISTING TOOLING \* : ON REQUEST

N.B.: MINIMUM LINE ORDER MAY APPLY

Tel.: (604) 278-6808  
Fax: (604) 278-6180

**SS 239**

[www.sealsonline.com](http://www.sealsonline.com)





## RADIAL SHAFT SEALS - FPM/STEEL

## GLOBAL AVAILABILITY LIST

Ref. Number	Dimensions			DESIGN TYPE										
	d	D	H	SC/V	SB2/V	SA2/V	TC/V	TB2/V	TA2/V	VB/V	VC/V	KB/V	KC/V	
S040062100	40.00	62.00	10.00	X	•	•	X	•	•	•	•	•	•	
S040062120	40.00	62.00	12.00	X	•	•	X	•	•	•	•	•	•	
S040062130	40.00	62.00	13.00	•	•	•	•	•	•	•	•	•	•	
S040062140	40.00	62.00	14.00	•	•	•	•	•	•	•	•	•	•	
S040065100	40.00	65.00	10.00	X	•	•	X	•	•	•	•	•	•	
S040065120	40.00	65.00	12.00	X	•	•	X	•	•	•	•	•	•	
S040065200	40.00	65.00	20.00	•	•	•	•	•	•	•	•	•	•	
S040068100	40.00	68.00	10.00	X	•	•	X	•	•	•	•	•	•	
S040068110	40.00	68.00	11.00	X	•	•	•	•	•	•	•	•	•	
S040068120	40.00	68.00	12.00	X	•	•	•	•	•	•	•	•	•	
S040070080	40.00	70.00	8.00	X	•	•	•	•	•	•	•	•	•	
S040070100	40.00	70.00	10.00	X	•	•	•	•	•	•	•	•	•	
S040070120	40.00	70.00	12.00	X	•	•	•	•	•	•	•	•	•	
S040072070	40.00	72.00	7.00	X	•	•	X	•	•	•	•	•	•	
S040072100	40.00	72.00	10.00	X	•	•	X	•	•	•	•	•	•	
S040072120	40.00	72.00	12.00	X	•	•	•	•	•	•	•	•	•	
S040078100	40.00	78.00	10.00	X	•	•	•	•	•	•	•	•	•	
S040080080	40.00	80.00	8.00	X	•	•	•	•	•	•	•	•	•	
S040080100	40.00	80.00	10.00	X	•	•	X	•	•	•	•	•	•	
S040080120	40.00	80.00	12.00	•	•	•	X	•	•	•	•	•	•	
S040080130	40.00	80.00	13.00	X	•	•	•	•	•	•	•	•	•	
S040085100	40.00	85.00	10.00	X	•	•	•	•	•	•	•	•	•	
S040090120	40.00	90.00	12.00	•	•	•	X	•	•	•	•	•	•	
S042050070	42.00	50.00	7.00	X	•	•	•	•	•	•	•	•	•	
S042055070	42.00	55.00	7.00	X	•	•	X	•	•	•	•	•	•	
S042055080	42.00	55.00	8.00	X	•	•	X	•	•	•	•	•	•	
S042055090	42.00	55.00	9.00	•	•	•	X	•	•	•	•	•	•	
S042055100	42.00	55.00	10.00	X	•	•	•	•	•	•	•	•	•	
S042056070	42.00	56.00	7.00	X	•	•	X	•	•	•	•	•	•	
S042058100	42.00	58.00	10.00	X	•	•	•	•	•	•	•	•	•	
S042060070	42.00	60.00	7.00	•	•	•	X	•	•	•	•	•	•	
S042060080	42.00	60.00	8.00	X	•	•	•	•	•	•	•	•	•	
S042060100	42.00	60.00	10.00	X	•	•	•	•	•	•	•	•	•	
S042060120	42.00	60.00	12.00	X	•	•	•	•	•	•	•	•	•	
S042062070	42.00	62.00	7.00	X	•	•	X	•	•	•	•	•	•	
S042062080	42.00	62.00	8.00	X	•	•	X	•	•	•	•	•	•	
S042062100	42.00	62.00	10.00	X	•	•	•	•	•	•	•	•	•	
S042062120	42.00	62.00	12.00	X	•	•	•	•	•	•	•	•	•	
S042065080	42.00	65.00	8.00	X	•	•	•	•	•	•	•	•	•	
S042065100	42.00	65.00	10.00	X	•	X	•	•	•	•	•	•	•	
S042065120	42.00	65.00	12.00	X	•	•	•	•	•	•	•	•	•	
S042068080	42.00	68.00	8.00	X	•	•	•	•	•	•	•	•	•	
S042068115	42.00	68.00	11.50	X	•	•	•	•	•	•	•	•	•	
S042072080	42.00	72.00	8.00	X	•	•	•	•	•	•	•	•	•	
S042072100	42.00	72.00	10.00	X	•	•	•	•	•	•	•	•	•	
S042072120	42.00	72.00	12.00	X	•	•	•	•	•	•	•	•	•	
S042080100	42.00	80.00	10.00	X	•	•	•	•	•	•	•	•	•	
S042081130	42.00	81.00	13.00	X	•	•	•	•	•	•	•	•	•	

X: EXISTING TOOLING •: ON REQUEST



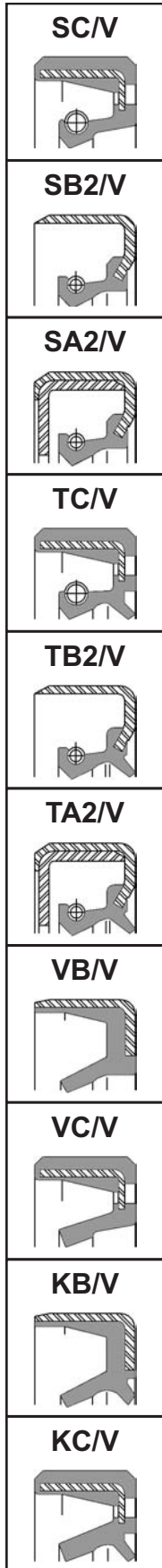





N.B.: MINIMUM LINE ORDER MAY APPLY



## GLOBAL AVAILABILITY LIST

## RADIAL SHAFT SEALS - FPM/STEEL

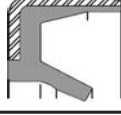
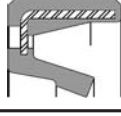
**METRIC SIZE  
SHAFT SEALS**

SC/V 	Ref. Number	Dimensions			DESIGN TYPE									
		d	D	H	SC/V	SB2/V	SA2/V	TC/V	TB2/V	TA2/V	VB/V	VC/V	KB/V	KC/V
	S043060100	43.00	60.00	10.00	X	.	.	.	.	.	.	.	.	.
	S043062100	43.00	62.00	10.00	X	.	.	.	.	.	.	.	.	.
	S043065130	43.00	65.00	13.00	X	.	.	.	.	.	.	.	.	.
SB2/V 	S043066100	43.00	66.00	10.00	X	.	.	.	.	.	.	.	.	.
	S043066120	43.00	66.00	12.00	X	.	.	.	.	.	.	.	.	.
	S043070120	43.00	70.00	12.00	X	.	.	.	.	.	.	.	.	.
	S043080100	43.00	80.00	10.00	X	.	.	.	.	.	.	.	.	.
	S044054045	44.00	54.00	4.50	X	.	.	.	.	.	.	.	.	.
SA2/V 	S044055070	44.00	55.00	7.00	X	.	.	.	.	.	.	.	.	.
	S044055100	44.00	55.00	10.00	.	.	.	.	.	.	.	.	.	.
	S044058100	44.00	58.00	10.00	X	.	.	.	.	.	.	.	.	.
	S044060100	44.00	60.00	10.00	X	.	.	.	.	.	.	.	.	.
	S044062100	44.00	62.00	10.00	X	.	.	X	.	.	.	.	.	.
TC/V 	S044065080	44.00	65.00	8.00	X	.	.	.	.	.	.	.	.	.
	S044065100	44.00	65.00	10.00	X	.	.	.	.	.	.	.	.	.
	S044072100	44.00	72.00	10.00	X	.	.	.	.	.	.	.	.	.
	S044073120	44.00	73.00	12.00	X	.	.	.	.	.	.	.	.	.
	S045055070	45.00	55.00	7.00	X	.	.	.	.	.	.	.	.	.
TB2/V 	S045055080	45.00	55.00	8.00	X	.	.	.	.	.	.	.	.	.
	S045055140	45.00	55.00	14.00	.	.	.	.	.	.	X	.	.	.
	S045056070	45.00	56.00	7.00	.	.	.	X	.	.	.	.	.	.
	S045058070	45.00	58.00	7.00	.	.	.	X	.	.	.	.	.	.
	S045060070	45.00	60.00	7.00	X	.	.	X	.	.	.	.	.	.
TA2/V 	S045060080	45.00	60.00	8.00	X	.	.	X	.	.	.	.	.	.
	S045060100	45.00	60.00	10.00	X	.	.	X	.	.	.	.	.	.
	S045060120	45.00	60.00	12.00	X	.	.	.	.	.	.	.	.	.
	S045062070	45.00	62.00	7.00	X	.	.	X	.	.	.	.	.	.
	S045062080	45.00	62.00	8.00	X	.	.	X	.	.	.	.	.	.
VB/V 	S045062100	45.00	62.00	10.00	X	.	.	X	.	.	.	.	.	.
	S045062110	45.00	62.00	11.00	.	.	.	.	.	.	.	.	.	.
	S045062120	45.00	62.00	12.00	X	.	.	.	.	.	.	.	.	.
	S045062140	45.00	62.00	14.00	.	.	.	.	.	.	.	.	.	.
	S045065080	45.00	65.00	8.00	X	.	.	X	.	.	.	.	.	.
VC/V 	S045065100	45.00	65.00	10.00	X	.	.	X	.	.	.	.	.	.
	S045065120	45.00	65.00	12.00	X	.	.	.	.	.	.	.	.	.
	S045066060	45.00	66.00	6.00	X	.	.	.	.	.	.	.	.	.
	S045066100	45.00	66.00	10.00	X	.	.	.	.	.	.	.	.	.
	S045068100	45.00	68.00	10.00	X	.	.	.	.	.	.	.	.	.
KB/V 	S045070100	45.00	70.00	10.00	X	.	.	.	.	.	.	.	.	.
	S045070120	45.00	70.00	12.00	X	.	.	.	.	.	.	.	.	.
	S045072080	45.00	72.00	8.00	X	.	.	X	.	.	.	.	.	.
	S045072090	45.00	72.00	9.00	X	.	.	.	.	.	.	.	.	.
	S045072100	45.00	72.00	10.00	X	.	.	X	.	.	.	.	.	.
KC/V 	S045072120	45.00	72.00	12.00	X	.	.	.	.	.	.	.	.	.
	S045075080	45.00	75.00	8.00	.	.	.	X	.	.	.	.	.	.
	S045075100	45.00	75.00	10.00	X	.	.	X	.	.	.	.	.	.
	S045080100	45.00	80.00	10.00	X	.	.	X	.	.	.	.	.	.
	S045080130	45.00	80.00	13.00	X	.	.	.	.	.	.	.	.	.

X: EXISTING TOOLING    .: ON REQUEST

N.B.: MINIMUM LINE ORDER MAY APPLY

**Tel.: (418) 688-3202**  
**Fax: (418) 688-4272**

**SS 241**

[www.sealsonline.com](http://www.sealsonline.com)



## RADIAL SHAFT SEALS - FPM/STEEL

## GLOBAL AVAILABILITY LIST

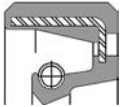
Ref. Number	Dimensions			DESIGN TYPE										SC/V 
	d	D	H	SC/V	SB2/V	SA2/V	TC/V	TB2/V	TA2/V	VB/V	VC/V	KB/V	KC/V	
S045085100	45.00	85.00	10.00	X	•	•	X	•	•	•	•	•	•	
S045090100	45.00	90.00	10.00	•	•	•	X	•	•	•	•	•	•	
S046064080	46.00	64.00	8.00	X	•	•	•	•	•	•	•	•	•	
S046064090	46.00	64.00	9.00	X	•	•	•	•	•	•	•	•	•	
S046065080	46.00	65.00	8.00	•	•	•	X	•	•	•	•	•	•	
S046072100	46.00	72.00	10.00	X	•	•	•	•	•	•	•	•	•	
S047058060	47.00	58.00	6.00	X	•	•	•	•	•	•	•	•	•	
S047062060	47.00	62.00	6.00	X	•	•	•	•	•	•	•	•	•	
S047065100	47.00	65.00	10.00	X	•	•	•	•	•	•	•	•	•	
S047067120	47.00	67.00	12.00	X	•	•	•	•	•	•	•	•	•	
S047072090	47.00	72.00	9.00	X	•	•	•	•	•	•	•	•	•	
S047080080	47.00	80.00	8.00	X	•	•	•	•	•	•	•	•	•	
S047080100	47.00	80.00	10.00	X	•	•	•	•	•	•	•	•	•	
S048062080	48.00	62.00	8.00	X	•	•	X	•	•	•	•	•	•	
S048062100	48.00	62.00	10.00	X	•	•	•	•	•	•	•	•	•	
S048065070	48.00	65.00	7.00	X	•	•	•	•	•	•	•	•	•	
S048065080	48.00	65.00	8.00	•	•	•	X	•	•	•	•	•	•	
S048065100	48.00	65.00	10.00	X	•	•	X	•	•	•	•	•	•	
S048068080	48.00	68.00	8.00	X	•	•	X	•	•	•	•	•	•	
S048068120	48.00	68.00	12.00	X	•	•	•	•	•	•	•	•	•	
S048068140	48.00	68.00	14.00	•	•	•	X	•	•	•	•	•	•	
S048070100	48.00	70.00	10.00	X	•	•	•	•	•	•	•	•	•	
S048072080	48.00	72.00	8.00	X	•	•	X	•	•	•	•	•	•	
S048072100	48.00	72.00	10.00	X	•	•	•	•	•	•	•	•	•	
S048072120	48.00	72.00	12.00	X	•	•	•	•	•	•	•	•	•	
S048072150	48.00	72.00	15.00	•	•	•	•	•	•	•	•	•	•	
S048074100	48.00	74.00	10.00	X	•	•	•	•	•	•	•	•	•	
S048080080	48.00	80.00	8.00	X	•	•	•	•	•	•	•	•	•	
S048080100	48.00	80.00	10.00	X	•	•	•	•	•	•	•	•	•	
S048085060	48.00	85.00	6.00	X	•	•	•	•	•	•	•	•	•	
S048085100	48.00	85.00	10.00	X	•	•	•	•	•	•	•	•	•	
S048085130	48.00	85.00	13.00	X	•	•	•	•	•	•	•	•	•	
S048090100	48.00	90.00	10.00	X	•	•	•	•	•	•	•	•	•	
S050058040	50.00	58.00	4.00	•	•	•	•	•	•	•	X	•	•	
S050058080	50.00	58.00	8.00	X	•	•	•	•	•	•	•	•	•	
S050060070	50.00	60.00	7.00	X	•	•	•	•	•	•	•	•	•	
S050062070	50.00	62.00	7.00	X	•	•	•	•	•	•	•	•	•	
S050065080	50.00	65.00	8.00	X	•	•	X	•	•	•	•	•	•	
S050065100	50.00	65.00	10.00	X	•	•	•	•	•	•	•	•	•	
S050066100	50.00	66.00	10.00	X	•	•	•	•	•	•	•	•	•	
S050068080	50.00	68.00	8.00	X	•	•	X	•	•	•	•	•	•	
S050068100	50.00	68.00	10.00	X	•	•	X	•	•	•	•	•	•	
S050068120	50.00	68.00	12.00	X	•	•	•	•	•	•	•	•	•	
S050070080	50.00	70.00	8.00	X	•	•	•	•	•	•	•	•	•	
S050070100	50.00	70.00	10.00	X	•	•	X	•	•	•	•	•	•	
S050070120	50.00	70.00	12.00	X	•	•	•	•	•	•	•	•	•	
S050072070	50.00	72.00	7.00	•	•	•	X	•	•	•	•	•	•	
S050072080	50.00	72.00	8.00	X	•	•	X	•	•	•	•	•	•	

X: EXISTING TOOLING •: ON REQUEST









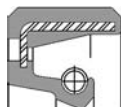

N.B.: MINIMUM LINE ORDER MAY APPLY

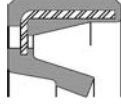

## GLOBAL AVAILABILITY LIST

## RADIAL SHAFT SEALS - FPM/STEEL

METRIC SIZE  
SHAFT SEALS

SC/V 	Ref. Number	Dimensions			DESIGN TYPE									
		d	D	H	SC/V	SB2/V	SA2/V	TC/V	TB2/V	TA2/V	VB/V	VC/V	KB/V	KC/V
	S050072100	50.00	72.00	10.00	X	•	•	X	•	•	•	•	•	•
	S050072120	50.00	72.00	12.00	X	•	•	X	•	•	•	•	•	•
	S050072130	50.00	72.00	13.00	•	•	•	•	•	•	•	•	•	•
	S050075100	50.00	75.00	10.00	X	•	•	X	•	•	•	•	•	•
	S050075120	50.00	75.00	12.00	X	•	•	•	•	•	•	•	•	•
	S050080080	50.00	80.00	8.00	X	•	•	X	•	•	•	•	•	•
	S050080100	50.00	80.00	10.00	X	•	X	X	•	•	•	•	•	•
	S050080130	50.00	80.00	13.00	•	•	•	X	•	•	•	•	•	•
	S050085100	50.00	85.00	10.00	X	•	•	•	•	•	•	•	•	•
	S050085130	50.00	85.00	13.00	X	•	•	•	•	•	•	•	•	•
	S050090100	50.00	90.00	10.00	X	•	•	X	•	•	•	•	•	•
	S052062080	52.00	62.00	8.00	X	•	•	•	•	•	•	•	•	•
	S052068080	52.00	68.00	8.00	X	•	•	X	•	•	•	•	•	•
	S052069100	52.00	69.00	10.00	X	•	•	•	•	•	•	•	•	•
	S052072080	52.00	72.00	8.00	X	•	•	X	•	•	•	•	•	•
	S052072100	52.00	72.00	10.00	X	•	•	•	•	•	•	•	•	•
	S052072120	52.00	72.00	12.00	X	•	•	•	•	•	•	•	•	•
	S052075100	52.00	75.00	10.00	X	•	•	•	•	•	•	•	•	•
	S052075120	52.00	75.00	12.00	X	•	•	•	•	•	•	•	•	•
	S052080100	52.00	80.00	10.00	X	•	•	•	•	•	•	•	•	•
	S052080130	52.00	80.00	13.00	X	•	•	•	•	•	•	•	•	•
	S053068100	53.00	68.00	10.00	X	•	•	•	•	•	•	•	•	•
	S053080100	53.00	80.00	10.00	X	•	•	•	•	•	•	•	•	•
	S054068105	54.00	68.00	10.50	X	•	•	•	•	•	•	•	•	•
	S054070120	54.00	70.00	12.00	X	•	•	•	•	•	•	•	•	•
	S054072100	54.00	72.00	10.00	X	•	•	•	•	•	•	•	•	•
	S054074080	54.00	74.00	8.00	X	•	•	•	•	•	•	•	•	•
	S054076125	54.00	76.00	12.50	X	•	•	•	•	•	•	•	•	•
	S054081100	54.00	81.00	10.00	•	•	•	X	•	•	•	•	•	•
	S054085100	54.00	85.00	10.00	X	•	•	•	•	•	•	•	•	•
	S054085150	54.00	85.00	15.00	X	•	•	•	•	•	•	•	•	•
	S054090100	54.00	90.00	10.00	X	•	•	•	•	•	•	•	•	•
	S054090130	54.00	90.00	13.00	X	•	•	•	•	•	•	•	•	•
	S055063050	55.00	63.00	5.00	•	•	•	•	•	•	•	X	•	•
	S055068080	55.00	68.00	8.00	X	•	•	•	•	•	•	•	•	•
	S055070080	55.00	70.00	8.00	X	•	•	X	•	•	•	•	•	•
	S055070100	55.00	70.00	10.00	X	•	•	X	•	•	•	•	•	•
	S055072080	55.00	72.00	8.00	X	•	•	X	•	•	•	•	•	•
	S055072100	55.00	72.00	10.00	X	•	•	X	•	•	•	•	•	•
	S055075080	55.00	75.00	8.00	X	•	•	X	•	•	•	•	•	•
	S055075100	55.00	75.00	10.00	X	•	•	X	•	•	•	•	•	•
	S055075120	55.00	75.00	12.00	X	•	•	•	•	•	•	•	•	•
	S055075150	55.00	75.00	15.00	•	•	•	•	•	•	•	•	•	•
	S055078100	55.00	78.00	10.00	X	•	•	•	•	•	•	•	•	•
	S055078120	55.00	78.00	12.00	•	•	•	X	•	•	•	•	•	•
	S055080080	55.00	80.00	8.00	X	•	•	X	•	•	•	•	•	•
	S055080100	55.00	80.00	10.00	X	•	•	X	•	•	•	•	•	•
	S055080120	55.00	80.00	12.00	X	•	•	•	•	•	•	•	•	•

X: EXISTING TOOLING    •: ON REQUEST

N.B.: MINIMUM LINE ORDER MAY APPLY

Tel.: (514) 334-2220  
Fax: (514) 333-8329

**SS 243**

[www.sealsonline.com](http://www.sealsonline.com)



## RADIAL SHAFT SEALS - FPM/STEEL

## GLOBAL AVAILABILITY LIST

Ref. Number	Dimensions			DESIGN TYPE										
	d	D	H	SC/V	SB2/V	SA2/V	TC/V	TB2/V	TA2/V	VB/V	VC/V	KB/V	KC/V	
S055080130	55.00	80.00	13.00	X	•	•	•	•	•	•	•	•	•	
S055085080	55.00	85.00	8.00	X	•	•	•	•	•	•	•	•	•	
S055085100	55.00	85.00	10.00	X	•	X	X	•	•	•	•	•	•	
S055085130	55.00	85.00	13.00	X	•	•	•	•	•	•	•	•	•	
S055085160	55.00	85.00	16.00	X	•	•	•	•	•	•	•	•	•	
S055090100	55.00	90.00	10.00	X	•	•	X	•	•	•	•	•	•	
S055090130	55.00	90.00	13.00	X	•	•	•	•	•	•	•	•	•	
S055100130	55.00	100.00	13.00	X	•	•	•	•	•	•	•	•	•	
S055100160	55.00	100.00	16.00	X	•	•	•	•	•	•	•	•	•	
S055120120	55.00	120.00	12.00	X	•	•	•	•	•	•	•	•	•	
S056070080	56.00	70.00	8.00	X	•	•	X	•	•	•	•	•	•	
S056072080	56.00	72.00	8.00	X	•	•	X	•	•	•	•	•	•	
S056072100	56.00	72.00	10.00	X	•	•	•	•	•	•	•	•	•	
S056076110	56.00	76.00	11.00	X	•	•	•	•	•	•	•	•	•	
S056080080	56.00	80.00	8.00	X	•	•	•	•	•	•	•	•	•	
S056080120	56.00	80.00	12.00	X	•	•	•	•	•	•	•	•	•	
S056085080	56.00	85.00	8.00	X	•	•	•	•	•	•	•	•	•	
S056088100	56.00	88.00	10.00	X	•	•	•	•	•	•	•	•	•	
S056088130	56.00	88.00	13.00	X	•	•	•	•	•	•	•	•	•	
S056090100	56.00	90.00	10.00	X	•	•	•	•	•	•	•	•	•	
S057085130	57.00	85.00	13.00	•	•	•	X	•	•	•	•	•	•	
S058072080	58.00	72.00	8.00	X	•	•	•	•	•	•	•	•	•	
S058072100	58.00	72.00	10.00	X	•	•	•	•	•	•	•	•	•	
S058075080	58.00	75.00	8.00	X	•	•	•	•	•	•	•	•	•	
S058078130	58.00	78.00	13.00	X	•	•	•	•	•	•	•	•	•	
S058080080	58.00	80.00	8.00	X	•	•	X	•	•	•	•	•	•	
S058080090	58.00	80.00	9.00	X	•	•	X	•	•	•	•	•	•	
S058080100	58.00	80.00	10.00	X	•	•	•	•	•	•	•	•	•	
S058085100	58.00	85.00	10.00	X	•	•	•	•	•	•	•	•	•	
S058085130	58.00	85.00	13.00	X	•	•	•	•	•	•	•	•	•	
S058086140	58.00	86.00	14.00	X	•	•	•	•	•	•	•	•	•	
S058090100	58.00	90.00	10.00	X	•	•	•	•	•	•	•	•	•	
S060072080	60.00	72.00	8.00	X	•	•	•	•	•	•	•	•	•	
S060075080	60.00	75.00	8.00	X	•	•	X	•	•	•	•	•	•	
S060075100	60.00	75.00	10.00	X	•	•	•	•	•	•	•	•	•	
S060075120	60.00	75.00	12.00	X	•	•	•	•	•	•	•	•	•	
S060078100	60.00	78.00	10.00	X	•	•	•	•	•	•	•	•	•	
S060080070	60.00	80.00	7.00	•	•	•	X	•	•	•	•	•	•	
S060080080	60.00	80.00	8.00	X	•	•	X	•	•	•	•	•	•	
S060080090	60.00	80.00	9.00	•	•	•	X	•	•	•	•	•	•	
S060080100	60.00	80.00	10.00	X	•	X	X	•	•	•	•	•	•	
S060080120	60.00	80.00	12.00	X	•	•	X	•	•	•	•	•	•	
S060080130	60.00	80.00	13.00	X	•	•	•	•	•	•	•	•	•	
S060082120	60.00	82.00	12.00	•	•	•	•	•	•	•	•	•	•	
S060085080	60.00	85.00	8.00	X	•	•	X	•	•	•	•	•	•	
S060085100	60.00	85.00	10.00	X	•	•	X	•	•	•	•	•	•	
S060085130	60.00	85.00	13.00	X	•	•	•	•	•	•	•	•	•	
S060090080	60.00	90.00	8.00	X	•	•	X	•	•	•	•	•	•	

X: EXISTING TOOLING ••: ON REQUEST



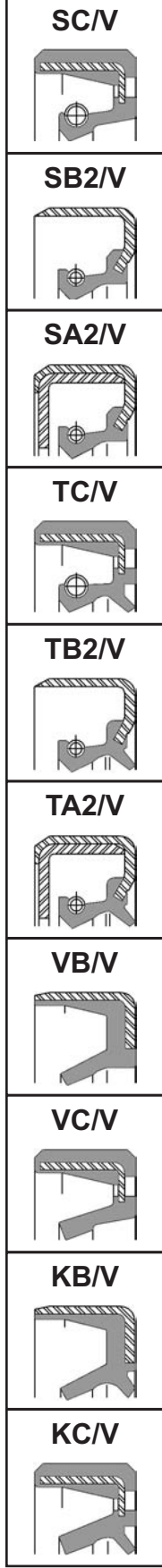





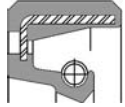

N.B.: MINIMUM LINE ORDER MAY APPLY



## GLOBAL AVAILABILITY LIST

## RADIAL SHAFT SEALS - FPM/STEEL

METRIC SIZE  
SHAFT SEALS

SC/V 	Ref. Number	Dimensions			DESIGN TYPE									
		d	D	H	SC/V	SB2/V	SA2/V	TC/V	TB2/V	TA2/V	VB/V	VC/V	KB/V	KC/V
	S060090100	60.00	90.00	10.00	X	•	X	X	•	•	•	•	•	•
	S060090130	60.00	90.00	13.00	X	•	•	•	•	•	•	•	•	•
	S060095100	60.00	95.00	10.00	X	•	•	•	•	•	•	•	•	•
	S060100100	60.00	100.00	10.00	X	•	•	•	•	•	•	•	•	•
	S060100130	60.00	100.00	13.00	X	•	•	•	•	•	•	•	•	•
	S060110120	60.00	110.00	12.00	X	•	•	•	•	•	•	•	•	•
	S060110130	60.00	110.00	13.00	X	•	•	•	•	•	•	•	•	•
	S060130120	60.00	130.00	12.00	X	•	•	•	•	•	•	•	•	•
	S061075080	61.00	75.00	8.00	X	•	•	•	•	•	•	•	•	•
	S061080130	61.00	80.00	13.00	X	•	•	•	•	•	•	•	•	•
	S062076100	62.00	76.00	10.00	X	•	•	•	•	•	•	•	•	•
	S062080100	62.00	80.00	10.00	X	•	•	•	•	•	•	•	•	•
	S062080120	62.00	80.00	12.00	X	•	•	•	•	•	•	•	•	•
	S062085100	62.00	85.00	10.00	X	•	•	•	•	•	•	•	•	•
	S062085120	62.00	85.00	12.00	X	•	•	•	•	•	•	•	•	•
	S062085130	62.00	85.00	13.00	X	•	•	•	•	•	•	•	•	•
	S062090100	62.00	90.00	10.00	X	•	•	•	•	•	•	•	•	•
	S062090110	62.00	90.00	11.00	X	•	•	•	•	•	•	•	•	•
	S062100100	62.00	100.00	10.00	X	•	•	•	•	•	•	•	•	•
	S063085100	63.00	85.00	10.00	X	•	•	X	•	•	•	•	•	•
	S063090100	63.00	90.00	10.00	X	•	•	X	•	•	•	•	•	•
	S064080080	64.00	80.00	8.00	X	•	•	•	•	•	•	•	•	•
	S064085130	64.00	85.00	13.00	X	•	•	•	•	•	•	•	•	•
	S064085160	64.00	85.00	16.00	•	•	•	X	•	•	•	•	•	•
	S064090130	64.00	90.00	13.00	•	•	•	X	•	•	•	•	•	•
	S065080080	65.00	80.00	8.00	X	•	•	X	•	•	•	•	•	•
	S065080100	65.00	80.00	10.00	X	•	•	X	•	•	•	•	•	•
	S065080120	65.00	80.00	12.00	X	•	•	•	•	•	•	•	•	•
	S065085080	65.00	85.00	8.00	X	•	•	•	•	•	•	•	•	•
	S065085100	65.00	85.00	10.00	X	•	•	X	•	•	•	•	•	•
	S065085120	65.00	85.00	12.00	X	•	X	•	•	•	•	•	•	•
	S065085130	65.00	85.00	13.00	X	•	•	X	•	•	•	•	•	•
	S065090100	65.00	90.00	10.00	X	•	•	X	•	•	•	•	•	•
	S065090120	65.00	90.00	12.00	X	•	X	•	•	•	•	•	•	•
	S065090130	65.00	90.00	13.00	X	•	•	•	•	•	•	•	•	•
	S065092130	65.00	92.00	13.00	X	•	•	•	•	•	•	•	•	•
	S065095100	65.00	95.00	10.00	X	•	•	•	•	•	•	•	•	•
	S065095130	65.00	95.00	13.00	X	•	•	•	•	•	•	•	•	•
	S065100100	65.00	100.00	10.00	X	•	•	X	•	•	•	•	•	•
	S065100120	65.00	100.00	12.00	X	•	•	•	•	•	•	•	•	•
	S065100130	65.00	100.00	13.00	X	•	•	•	•	•	•	•	•	•
	S065110100	65.00	110.00	10.00	X	•	•	•	•	•	•	•	•	•
	S065125120	65.00	125.00	12.00	X	•	•	•	•	•	•	•	•	•
	S068090060	68.00	90.00	6.00	X	•	•	X	•	•	•	•	•	•
	S068090100	68.00	90.00	10.00	X	•	•	X	•	•	•	•	•	•
	S068095130	68.00	95.00	13.00	X	•	•	•	•	•	•	•	•	•
	S068100100	68.00	100.00	10.00	X	•	•	•	•	•	•	•	•	•
	S068100130	68.00	100.00	13.00	X	•	•	•	•	•	•	•	•	•

X: EXISTING TOOLING    •: ON REQUEST

N.B.: MINIMUM LINE ORDER MAY APPLY

Tel.: (888) 238-5885  
Fax: (888) 238-1664

**SS 245**

[www.sealsonline.com](http://www.sealsonline.com)



**M**

## RADIAL SHAFT SEALS - FPM/STEEL

## GLOBAL AVAILABILITY LIST

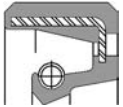
Ref. Number	Dimensions			DESIGN TYPE										SC/V 
	d	D	H	SC/V	SB2/V	SA2/V	TC/V	TB2/V	TA2/V	VB/V	VC/V	KB/V	KC/V	
S070085070	70.00	85.00	7.00	X	•	•	•	•	•	•	•	•	•	•
S070085080	70.00	85.00	8.00	X	•	•	X	•	•	•	•	•	•	•
S070085100	70.00	85.00	10.00	X	•	•	•	•	•	•	•	•	•	•
S070085160	70.00	85.00	16.00	•	•	•	•	•	•	•	•	•	•	•
S070088090	70.00	88.00	9.00	X	•	•	•	•	•	•	•	•	•	•
S070090100	70.00	90.00	10.00	X	•	•	X	•	•	•	•	•	•	•
S070090120	70.00	90.00	12.00	X	•	X	X	•	•	•	•	•	•	•
S070090130	70.00	90.00	13.00	X	•	•	X	•	•	•	•	•	•	•
S070092130	70.00	92.00	13.00	X	•	•	•	•	•	•	•	•	•	•
S070095100	70.00	95.00	10.00	X	•	•	X	•	•	•	•	•	•	•
S070095130	70.00	95.00	13.00	X	•	•	•	•	•	•	•	•	•	•
S070100080	70.00	100.00	8.00	•	•	•	X	•	•	•	•	•	•	•
S070100100	70.00	100.00	10.00	X	•	•	X	•	•	•	•	•	•	•
S070100120	70.00	100.00	12.00	X	•	•	•	•	•	•	•	•	•	•
S070100130	70.00	100.00	13.00	X	•	•	•	•	•	•	•	•	•	•
S070105130	70.00	105.00	13.00	X	•	•	•	•	•	•	•	•	•	•
S070110100	70.00	110.00	10.00	X	•	•	•	•	•	•	•	•	•	•
S070110120	70.00	110.00	12.00	X	•	•	•	•	•	•	•	•	•	•
S070110130	70.00	110.00	13.00	X	•	•	X	•	•	•	•	•	•	•
S070112120	70.00	112.00	12.00	X	•	•	•	•	•	•	•	•	•	•
S070120130	70.00	120.00	13.00	X	•	•	•	•	•	•	•	•	•	•
S070135120	70.00	135.00	12.00	X	•	•	•	•	•	•	•	•	•	•
S072085080	72.00	85.00	8.00	X	•	•	•	•	•	•	•	•	•	•
S072085100	72.00	85.00	10.00	X	•	•	•	•	•	•	•	•	•	•
S072090100	72.00	90.00	10.00	X	•	•	•	•	•	•	•	•	•	•
S072095100	72.00	95.00	10.00	X	•	•	•	•	•	•	•	•	•	•
S072095120	72.00	95.00	12.00	X	•	•	•	•	•	•	•	•	•	•
S072095130	72.00	95.00	13.00	X	•	•	•	•	•	•	•	•	•	•
S072100100	72.00	100.00	10.00	X	•	•	X	•	•	•	•	•	•	•
S072100130	72.00	100.00	13.00	X	•	•	•	•	•	•	•	•	•	•
S073100130	73.00	100.00	13.00	X	•	•	•	•	•	•	•	•	•	•
S074105120	74.00	105.00	12.00	X	•	•	•	•	•	•	•	•	•	•
S075090080	75.00	90.00	8.00	X	•	•	X	•	•	•	•	•	•	•
S075090100	75.00	90.00	10.00	X	•	•	•	•	•	•	•	•	•	•
S075090150	75.00	90.00	15.00	•	•	•	•	•	•	•	•	•	•	•
S075095100	75.00	95.00	10.00	X	•	•	X	•	•	•	•	•	•	•
S075095120	75.00	95.00	12.00	X	•	X	•	•	•	•	•	•	•	•
S075095140	75.00	95.00	14.00	•	•	•	•	•	•	•	•	•	•	•
S075095150	75.00	95.00	15.00	•	•	•	•	•	•	•	•	•	•	•
S075100100	75.00	100.00	10.00	X	•	•	X	•	•	•	•	•	•	•
S075100120	75.00	100.00	12.00	X	•	X	X	•	•	•	•	•	•	•
S075100130	75.00	100.00	13.00	X	•	•	•	•	•	•	•	•	•	•
S075101120	75.00	101.00	12.00	X	•	•	•	•	•	•	•	•	•	•
S075110120	75.00	110.00	12.00	X	•	•	•	•	•	•	•	•	•	•
S075110130	75.00	110.00	13.00	X	•	•	•	•	•	•	•	•	•	•
S075112120	75.00	112.00	12.00	X	•	•	•	•	•	•	•	•	•	•
S075120100	75.00	120.00	10.00	X	•	•	•	•	•	•	•	•	•	•
S075120120	75.00	120.00	12.00	X	•	•	•	•	•	•	•	•	•	•

X: EXISTING TOOLING •: ON REQUEST









N.B.: MINIMUM LINE ORDER MAY APPLY

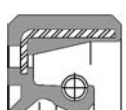

## GLOBAL AVAILABILITY LIST

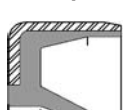
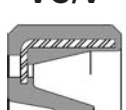
## RADIAL SHAFT SEALS - FPM/STEEL

**METRIC SIZE  
SHAFT SEALS**

SC/V 	Ref. Number	Dimensions			DESIGN TYPE									
		d	D	H	SC/V	SB2/V	SA2/V	TC/V	TB2/V	TA2/V	VB/V	VC/V	KB/V	KC/V
	S076105130	76.00	105.00	13.00	X	.	.	.	.	.	.	.	.	.
	S077100100	77.00	100.00	10.00	X	.	.	.	.	.	.	.	.	.
	S078095110	78.00	95.00	11.00	X	.	.	.	.	.	.	.	.	.
	S078095130	78.00	95.00	13.00	X	.	.	.	.	.	.	.	.	.
	S078100100	78.00	100.00	10.00	X	.	.	.	.	.	.	.	.	.
	S078105130	78.00	105.00	13.00	X	.	.	.	.	.	.	.	.	.
	S078110120	78.00	110.00	12.00	X	.	.	.	.	.	.	.	.	.
	S080090050	80.00	90.00	5.00	.	.	.	.	.	.	.	X	.	.
	S080095080	80.00	95.00	8.00	X	.	.	.	.	.	.	.	.	.
	S080100100	80.00	100.00	10.00	X	.	.	X	.	.	.	.	.	.
	S080100120	80.00	100.00	12.00	X	.	X	.	.	.	.	.	.	.
	S080100130	80.00	100.00	13.00	X	.	.	X	.	.	.	.	.	.
	S080100140	80.00	100.00	14.00	.	.	.	.	.	.	.	.	.	.
	S080105100	80.00	105.00	10.00	X	.	.	.	.	.	.	.	.	.
	S080105120	80.00	105.00	12.00	X	.	.	.	.	.	.	.	.	.
	S080105130	80.00	105.00	13.00	X	.	.	.	.	.	.	.	.	.
	S080110100	80.00	110.00	10.00	X	.	.	X	.	.	.	.	.	.
	S080110120	80.00	110.00	12.00	X	.	.	.	.	.	.	.	.	.
	S080110130	80.00	110.00	13.00	X	.	.	.	.	.	.	.	.	.
	S080113120	80.00	113.00	12.00	X	.	.	.	.	.	.	.	.	.
	S080115120	80.00	115.00	12.00	X	.	.	.	.	.	.	.	.	.
	S080120130	80.00	120.00	13.00	X	.	.	.	.	.	.	.	.	.
	S080125120	80.00	125.00	12.00	X	.	.	.	.	.	.	.	.	.
	S080130130	80.00	130.00	13.00	X	.	.	.	.	.	.	.	.	.
	S080140130	80.00	140.00	13.00	X	.	.	.	.	.	.	.	.	.
	S080145130	80.00	145.00	13.00	X	.	.	.	.	.	.	.	.	.
	S082105120	82.00	105.00	12.00	X	.	.	.	.	.	.	.	.	.
	S082110120	82.00	110.00	12.00	X	.	.	.	.	.	.	.	.	.
	S083110130	83.00	110.00	13.00	X	.	.	.	.	.	.	.	.	.
	S084110160	84.00	110.00	16.00	.	.	.	X	.	.	.	.	.	.
	S085105100	85.00	105.00	10.00	X	.	.	.	.	.	.	.	.	.
	S085105120	85.00	105.00	12.00	X	.	.	X	.	.	.	.	.	.
	S085105130	85.00	105.00	13.00	X	.	.	.	.	.	.	.	.	.
	S085110100	85.00	110.00	10.00	X	.	.	.	.	.	.	.	.	.
	S085110120	85.00	110.00	12.00	X	.	X	X	.	.	.	.	.	.
	S085110130	85.00	110.00	13.00	X	.	.	X	.	.	.	.	.	.
	S085115130	85.00	115.00	13.00	X	.	.	.	.	.	.	.	.	.
	S085120120	85.00	120.00	12.00	X	.	.	X	.	.	.	.	.	.
	S085120130	85.00	120.00	13.00	X	.	.	X	.	.	.	.	.	.
	S085125120	85.00	125.00	12.00	X	.	.	.	.	.	.	.	.	.
	S085126130	85.00	126.00	13.00	X	.	.	.	.	.	.	.	.	.
	S085130120	85.00	130.00	12.00	.	.	.	X	.	.	.	.	.	.
	S085130130	85.00	130.00	13.00	.	.	.	X	.	.	.	.	.	.
	S086100070	86.00	100.00	7.00	X	.	.	.	.	.	.	.	.	.
	S086120150	86.00	120.00	15.00	.	.	.	.	.	.	.	.	.	.
	S087110130	87.00	110.00	13.00	X	.	.	.	.	.	.	.	.	.
	S088110120	88.00	110.00	12.00	X	.	.	.	.	.	.	.	.	.
	S088110130	88.00	110.00	13.00	X	.	.	.	.	.	.	.	.	.

X: EXISTING TOOLING    \*: ON REQUEST

N.B.: MINIMUM LINE ORDER MAY APPLY

**Tel.: (204) 783-9617**  
**Fax: (204) 783-6091**

**SS 247**

[www.sealsonline.com](http://www.sealsonline.com)





## RADIAL SHAFT SEALS - FPM/STEEL

## GLOBAL AVAILABILITY LIST

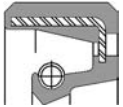
Ref. Number	Dimensions			DESIGN TYPE										SC/V 
	d	D	H	SC/V	SB2/V	SA2/V	TC/V	TB2/V	TA2/V	VB/V	VC/V	KB/V	KC/V	
S088120120	88.00	120.00	12.00	X	•	•	•	•	•	•	•	•	•	
S088126120	88.00	126.00	12.00	X	•	•	•	•	•	•	•	•	•	
S088128120	88.00	128.00	12.00	X	•	•	•	•	•	•	•	•	•	
S088140130	88.00	140.00	13.00	X	•	•	•	•	•	•	•	•	•	
S090110100	90.00	110.00	10.00	X	•	•	•	•	•	•	•	•	•	
S090110120	90.00	110.00	12.00	X	•	X	X	•	•	•	•	•	•	
S090110130	90.00	110.00	13.00	X	•	•	X	•	•	•	•	•	•	
S090115090	90.00	115.00	9.00	X	•	•	•	•	•	•	•	•	•	
S090115120	90.00	115.00	12.00	X	•	•	X	•	•	•	•	•	•	
S090115130	90.00	115.00	13.00	X	•	•	•	•	•	•	•	•	•	
S090120090	90.00	120.00	9.00	X	•	•	•	•	•	•	•	•	•	
S090120120	90.00	120.00	12.00	X	•	X	•	•	•	•	•	•	•	
S090120130	90.00	120.00	13.00	X	•	•	•	•	•	•	•	•	•	
S090125140	90.00	125.00	14.00	X	•	•	•	•	•	•	•	•	•	
S090130130	90.00	130.00	13.00	X	•	•	•	•	•	•	•	•	•	
S091136120	91.00	136.00	12.00	X	•	•	•	•	•	•	•	•	•	
S092120130	92.00	120.00	13.00	X	•	•	•	•	•	•	•	•	•	
S092120140	92.00	120.00	14.00	X	•	•	•	•	•	•	•	•	•	
S093115130	93.00	115.00	13.00	X	•	•	•	•	•	•	•	•	•	
S095110060	95.00	110.00	6.00	X	•	•	•	•	•	•	•	•	•	
S095110100	95.00	110.00	10.00	X	•	•	•	•	•	•	•	•	•	
S095110120	95.00	110.00	12.00	X	•	•	•	•	•	•	•	•	•	
S095115130	95.00	115.00	13.00	X	•	X	X	•	•	•	•	•	•	
S095120100	95.00	120.00	10.00	•	•	•	X	•	•	•	•	•	•	
S095120120	95.00	120.00	12.00	X	•	X	X	•	•	•	•	•	•	
S095120130	95.00	120.00	13.00	X	•	•	X	•	•	•	•	•	•	
S095125120	95.00	125.00	12.00	X	•	•	X	•	•	•	•	•	•	
S095125130	95.00	125.00	13.00	X	•	•	X	•	•	•	•	•	•	
S095130130	95.00	130.00	13.00	X	•	•	•	•	•	•	•	•	•	
S095135130	95.00	135.00	13.00	X	•	•	•	•	•	•	•	•	•	
S095150150	95.00	150.00	15.00	X	•	•	•	•	•	•	•	•	•	
S095160150	95.00	160.00	15.00	X	•	•	•	•	•	•	•	•	•	
S096117100	96.00	117.00	10.00	X	•	•	•	•	•	•	•	•	•	
S096136120	96.00	136.00	12.00	X	•	•	•	•	•	•	•	•	•	
S097130140	97.00	130.00	14.00	X	•	•	•	•	•	•	•	•	•	
S098120130	98.00	120.00	13.00	X	•	•	•	•	•	•	•	•	•	
S098125130	98.00	125.00	13.00	X	•	•	•	•	•	•	•	•	•	
S098128100	98.00	128.00	10.00	X	•	•	•	•	•	•	•	•	•	
S100115090	100.00	115.00	9.00	•	•	•	X	•	•	•	•	•	•	
S100120100	100.00	120.00	10.00	X	•	•	X	•	•	•	•	•	•	
S100120120	100.00	120.00	12.00	X	•	X	X	•	•	•	•	•	•	
S100120130	100.00	120.00	13.00	X	•	•	X	•	•	•	•	•	•	
S100125120	100.00	125.00	12.00	X	•	X	X	•	•	•	•	•	•	
S100125130	100.00	125.00	13.00	X	•	•	•	•	•	•	•	•	•	
S100127130	100.00	127.00	13.00	X	•	•	•	•	•	•	•	•	•	
S100130120	100.00	130.00	12.00	X	•	X	X	•	•	•	•	•	•	
S100130130	100.00	130.00	13.00	X	•	•	•	•	•	•	•	•	•	
S100130140	100.00	130.00	14.00	X	•	•	•	•	•	•	•	•	•	

X: EXISTING TOOLING •: ON REQUEST









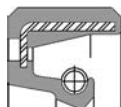

N.B.: MINIMUM LINE ORDER MAY APPLY

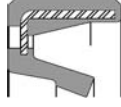

## GLOBAL AVAILABILITY LIST

## RADIAL SHAFT SEALS - FPM/STEEL

METRIC SIZE  
SHAFT SEALS

SC/V 	Ref. Number	Dimensions			DESIGN TYPE									
		d	D	H	SC/V	SB2/V	SA2/V	TC/V	TB2/V	TA2/V	VB/V	VC/V	KB/V	KC/V
	S100135130	100.00	135.00	13.00	•	•	•	X	•	•	•	•	•	•
	S100135150	100.00	135.00	15.00	•	•	•	X	•	•	•	•	•	•
	S100140130	100.00	140.00	13.00	X	•	•	•	•	•	•	•	•	•
	S100150130	100.00	150.00	13.00	X	•	•	•	•	•	•	•	•	•
	S104120130	104.00	120.00	13.00	X	•	•	•	•	•	•	•	•	•
	S104125100	104.00	125.00	10.00	X	•	•	•	•	•	•	•	•	•
	S105125130	105.00	125.00	13.00	X	•	•	X	•	•	•	•	•	•
	S105130120	105.00	130.00	12.00	X	•	X	X	•	•	•	•	•	•
	S105130130	105.00	130.00	13.00	X	•	•	X	•	•	•	•	•	•
	S105130150	105.00	130.00	15.00	X	•	•	•	•	•	•	•	•	•
	S105132120	105.00	132.00	12.00	X	•	•	•	•	•	•	•	•	•
	S105135120	105.00	135.00	12.00	X	•	•	•	•	•	•	•	•	•
	S105135130	105.00	135.00	13.00	X	•	•	•	•	•	•	•	•	•
	S105140120	105.00	140.00	12.00	X	•	•	•	•	•	•	•	•	•
	S105140130	105.00	140.00	13.00	X	•	•	•	•	•	•	•	•	•
	S105145160	105.00	145.00	16.00	X	•	•	•	•	•	•	•	•	•
	S110128090	110.00	128.00	9.00	X	•	•	•	•	•	•	•	•	•
	S110130080	110.00	130.00	8.00	X	•	•	•	•	•	•	•	•	•
	S110130120	110.00	130.00	12.00	X	•	X	X	•	•	•	•	•	•
	S110130130	110.00	130.00	13.00	X	•	•	•	•	•	•	•	•	•
	S110130145	110.00	130.00	14.50	X	•	•	•	•	•	•	•	•	•
	S110135120	110.00	135.00	12.00	X	•	•	•	•	•	•	•	•	•
	S110135130	110.00	135.00	13.00	X	•	•	•	•	•	•	•	•	•
	S110140120	110.00	140.00	12.00	X	•	X	X	•	•	•	•	•	•
	S110140130	110.00	140.00	13.00	X	•	•	•	•	•	•	•	•	•
	S110145130	110.00	145.00	13.00	X	•	•	•	•	•	•	•	•	•
	S110150130	110.00	150.00	13.00	X	•	•	•	•	•	•	•	•	•
	S110150150	110.00	150.00	15.00	X	•	•	•	•	•	•	•	•	•
	S110150180	110.00	150.00	18.00	•	•	•	•	•	•	•	•	•	•
	S110155150	110.00	155.00	15.00	X	•	•	•	•	•	•	•	•	•
	S110200130	110.00	200.00	13.00	X	•	•	•	•	•	•	•	•	•
	S112140130	112.00	140.00	13.00	X	•	•	X	•	•	•	•	•	•
	S114140130	114.00	140.00	13.00	X	•	•	•	•	•	•	•	•	•
	S115130120	115.00	130.00	12.00	X	•	•	•	•	•	•	•	•	•
	S115135090	115.00	135.00	9.00	X	•	•	•	•	•	•	•	•	•
	S115135100	115.00	135.00	10.00	X	•	•	•	•	•	•	•	•	•
	S115137090	115.00	137.00	9.00	X	•	•	•	•	•	•	•	•	•
	S115140100	115.00	140.00	10.00	X	•	•	•	•	•	•	•	•	•
	S115140120	115.00	140.00	12.00	X	•	X	X	•	•	•	•	•	•
	S115145130	115.00	145.00	13.00	X	•	•	•	•	•	•	•	•	•
	S115145180	115.00	145.00	18.00	•	•	•	•	•	•	•	•	•	•
	S115150120	115.00	150.00	12.00	X	•	•	X	•	•	•	•	•	•
	S115160150	115.00	160.00	15.00	X	•	•	•	•	•	•	•	•	•
	S118140160	118.00	140.00	16.00	•	•	•	•	•	•	•	•	•	•
	S118150150	118.00	150.00	15.00	•	•	•	•	•	•	•	•	•	•
	S120135120	120.00	135.00	12.00	X	•	•	•	•	•	•	•	•	•
	S120140100	120.00	140.00	10.00	X	•	•	•	•	•	•	•	•	•
	S120140120	120.00	140.00	12.00	•	•	•	X	•	•	•	•	•	•

X: EXISTING TOOLING    •: ON REQUEST

N.B.: MINIMUM LINE ORDER MAY APPLY

Tel.: (780) 414-1871  
Fax: (780) 487-5419

**SS 249**

[www.sealsonline.com](http://www.sealsonline.com)



## RADIAL SHAFT SEALS - FPM/STEEL

## GLOBAL AVAILABILITY LIST

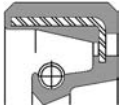
Ref. Number	Dimensions			DESIGN TYPE										SC/V 
	d	D	H	SC/V	SB2/V	SA2/V	TC/V	TB2/V	TA2/V	VB/V	VC/V	KB/V	KC/V	
S120140130	120.00	140.00	13.00	X	•	•	X	•	•	•	•	•	•	
S120150120	120.00	150.00	12.00	X	•	•	X	•	•	•	•	•	•	
S120150130	120.00	150.00	13.00	X	•	•	X	•	•	•	•	•	•	
S120150150	120.00	150.00	15.00	X	•	X	X	•	•	•	•	•	•	
S120150160	120.00	150.00	16.00	X	•	•	•	•	•	•	•	•	•	
S120160120	120.00	160.00	12.00	X	•	•	X	•	•	•	•	•	•	
S120160130	120.00	160.00	13.00	X	•	•	•	•	•	•	•	•	•	
S120160150	120.00	160.00	15.00	X	•	•	•	•	•	•	•	•	•	
S125140100	125.00	140.00	10.00	X	•	•	•	•	•	•	•	•	•	
S125150120	125.00	150.00	12.00	X	•	•	X	•	•	•	•	•	•	
S125150130	125.00	150.00	13.00	X	•	•	•	•	•	•	•	•	•	
S125150150	125.00	150.00	15.00	X	•	X	•	•	•	•	•	•	•	
S125155120	125.00	155.00	12.00	X	•	•	X	•	•	•	•	•	•	
S125160120	125.00	160.00	12.00	X	•	•	•	•	•	•	•	•	•	
S125160150	125.00	160.00	15.00	X	•	•	•	•	•	•	•	•	•	
S127170140	127.00	170.00	14.00	X	•	•	•	•	•	•	•	•	•	
S128146135	128.00	146.00	13.50	X	•	•	X	•	•	•	•	•	•	
S128150130	128.00	150.00	13.00	X	•	•	•	•	•	•	•	•	•	
S128158200	128.00	158.00	20.00	X	•	•	•	•	•	•	•	•	•	
S130150100	130.00	150.00	10.00	X	•	•	•	•	•	•	•	•	•	
S130150120	130.00	150.00	12.00	•	•	•	X	•	•	•	•	•	•	
S130150150	130.00	150.00	15.00	•	•	•	X	•	•	•	•	•	•	
S130160120	130.00	160.00	12.00	X	•	•	X	•	•	•	•	•	•	
S130160130	130.00	160.00	13.00	X	•	•	•	•	•	•	•	•	•	
S130160150	130.00	160.00	15.00	X	•	•	X	•	•	•	•	•	•	
S130165130	130.00	165.00	13.00	X	•	•	•	•	•	•	•	•	•	
S130170120	130.00	170.00	12.00	X	•	•	X	•	•	•	•	•	•	
S130170130	130.00	170.00	13.00	X	•	•	•	•	•	•	•	•	•	
S130170150	130.00	170.00	15.00	X	•	•	•	•	•	•	•	•	•	
S130182160	130.00	182.00	16.00	X	•	•	•	•	•	•	•	•	•	
S130230150	130.00	230.00	15.00	X	•	•	•	•	•	•	•	•	•	
S135160120	135.00	160.00	12.00	X	•	•	•	•	•	•	•	•	•	
S135160130	135.00	160.00	13.00	X	•	•	•	•	•	•	•	•	•	
S135160150	135.00	160.00	15.00	•	•	•	X	•	•	•	•	•	•	
S135165120	135.00	165.00	12.00	X	•	•	•	•	•	•	•	•	•	
S135165150	135.00	165.00	15.00	X	•	•	•	•	•	•	•	•	•	
S135170120	135.00	170.00	12.00	X	•	•	•	•	•	•	•	•	•	
S135170150	135.00	170.00	15.00	X	•	X	X	•	•	•	•	•	•	
S138160150	138.00	160.00	15.00	X	•	•	•	•	•	•	•	•	•	
S140162120	140.00	162.00	12.00	X	•	•	•	•	•	•	•	•	•	
S140165120	140.00	165.00	12.00	X	•	•	•	•	•	•	•	•	•	
S140165150	140.00	165.00	15.00	X	•	•	•	•	•	•	•	•	•	
S140165160	140.00	165.00	16.00	X	•	•	•	•	•	•	•	•	•	
S140170120	140.00	170.00	12.00	X	•	•	X	•	•	•	•	•	•	
S140170130	140.00	170.00	13.00	X	•	•	X	•	•	•	•	•	•	
S140170140	140.00	170.00	14.00	•	•	•	X	•	•	•	•	•	•	
S140170150	140.00	170.00	15.00	X	•	X	X	•	•	•	•	•	•	
S140180120	140.00	180.00	12.00	X	•	•	•	•	•	•	•	•	•	

X: EXISTING TOOLING •: ON REQUEST

N.B.: MINIMUM LINE ORDER MAY APPLY



## GLOBAL AVAILABILITY LIST

## RADIAL SHAFT SEALS - FPM/STEEL

**METRIC SIZE  
SHAFT SEALS**

SC/V 	Ref. Number	Dimensions			DESIGN TYPE									
		d	D	H	SC/V	SB2/V	SA2/V	TC/V	TB2/V	TA2/V	VB/V	VC/V	KB/V	KC/V
	S140180130	140.00	180.00	13.00	X	.	.	.	.	.	.	.	.	.
	S140180150	140.00	180.00	15.00	X	.	.	.	.	.	.	.	.	.
	S144160120	144.00	160.00	12.00	X	.	.	.	.	.	.	.	.	.
	S145165130	145.00	165.00	13.00	X	.	.	.	.	.	.	.	.	.
	S145170150	145.00	170.00	15.00	X	.	.	X	.	.	.	.	.	.
	S145175150	145.00	175.00	15.00	X	.	.	X	.	.	.	.	.	.
	S145180120	145.00	180.00	12.00	X	.	.	.	.	.	.	.	.	.
	S145180130	145.00	180.00	13.00	X	.	.	.	.	.	.	.	.	.
	S145180140	145.00	180.00	14.00	X	.	.	.	.	.	.	.	.	.
	S146163070	146.00	163.00	7.00	X	.	.	.	.	.	.	.	.	.
	S148170145	148.00	170.00	14.50	X	.	.	.	.	.	.	.	.	.
	S150170120	150.00	170.00	12.00	X	.	.	.	.	.	.	.	.	.
	S150170150	150.00	170.00	15.00	X	.	.	.	.	.	.	.	.	.
	S150180100	150.00	180.00	10.00	.	.	.	X	.	.	.	.	.	.
	S150180120	150.00	180.00	12.00	X	.	.	.	.	.	.	.	.	.
	S150180130	150.00	180.00	13.00	X	.	.	X	.	.	.	.	.	.
	S150180140	150.00	180.00	14.00	.	.	.	X	.	.	.	.	.	.
	S150180150	150.00	180.00	15.00	X	.	X	X	.	.	.	.	.	.
	S150180180	150.00	180.00	18.00	.	.	.	.	.	.	.	.	.	.
	S155174120	155.00	174.00	12.00	X	.	.	.	.	.	.	.	.	.
	S155175120	155.00	175.00	12.00	X	.	.	.	.	.	.	.	.	.
	S155177120	155.00	177.00	12.00	X	.	.	.	.	.	.	.	.	.
	S155180130	155.00	180.00	13.00	X	.	.	.	.	.	.	.	.	.
	S155180150	155.00	180.00	15.00	X	.	.	.	.	.	.	.	.	.
	S155185150	155.00	185.00	15.00	.	.	.	X	.	.	.	.	.	.
	S158180150	158.00	180.00	15.00	X	.	.	.	.	.	.	.	.	.
	S160180100	160.00	180.00	10.00	.	.	.	X	.	.	.	.	.	.
	S160185100	160.00	185.00	10.00	X	.	.	.	.	.	.	.	.	.
	S160185150	160.00	185.00	15.00	X	.	.	.	.	.	.	.	.	.
	S160190130	160.00	190.00	13.00	X	.	.	.	.	.	.	.	.	.
	S160190150	160.00	190.00	15.00	X	.	X	X	.	.	.	.	.	.
	S160200120	160.00	200.00	12.00	X	.	.	.	.	.	.	.	.	.
	S160200150	160.00	200.00	15.00	X	.	.	.	.	.	.	.	.	.
	S162190120	162.00	190.00	12.00	X	.	.	.	.	.	.	.	.	.
	S165190130	165.00	190.00	13.00	X	.	.	.	.	.	.	.	.	.
	S165200150	165.00	200.00	15.00	X	.	.	.	.	.	.	.	.	.
	S170190150	170.00	190.00	15.00	X	.	.	.	.	.	.	.	.	.
	S170192120	170.00	192.00	12.00	X	.	.	.	.	.	.	.	.	.
	S170200120	170.00	200.00	12.00	X	.	.	.	.	.	.	.	.	.
	S170200130	170.00	200.00	13.00	X	.	.	.	.	.	.	.	.	.
	S170200150	170.00	200.00	15.00	X	.	X	X	.	.	.	.	.	.
	S175200100	175.00	200.00	10.00	X	.	.	.	.	.	.	.	.	.
	S175200150	175.00	200.00	15.00	X	.	.	.	.	.	.	.	.	.
	S175210140	175.00	210.00	14.00	X	.	.	.	.	.	.	.	.	.
	S180200130	180.00	200.00	13.00	X	.	.	.	.	.	.	.	.	.
	S180200150	180.00	200.00	15.00	X	.	.	.	.	.	.	.	.	.
	S180200160	180.00	200.00	16.00	.	.	.	X	.	.	.	.	.	.
	S180202120	180.00	202.00	12.00	X	.	.	.	.	.	.	.	.	.

X: EXISTING TOOLING    .: ON REQUEST

N.B.: MINIMUM LINE ORDER MAY APPLY

**Tel.: (604) 278-6808**  
**Fax: (604) 278-6180**

**SS 251**

[www.sealsonline.com](http://www.sealsonline.com)



## RADIAL SHAFT SEALS - FPM/STEEL

## GLOBAL AVAILABILITY LIST

Ref. Number	Dimensions			DESIGN TYPE										
	d	D	H	SC/V	SB2/V	SA2/V	TC/V	TB2/V	TA2/V	VB/V	VC/V	KB/V	KC/V	
S180210150	180.00	210.00	15.00	X	•	•	X	•	•	•	•	•	•	
S180215150	180.00	215.00	15.00	X	•	•	•	•	•	•	•	•	•	
S180215160	180.00	215.00	16.00	X	•	•	•	•	•	•	•	•	•	
S180220150	180.00	220.00	15.00	X	•	•	•	•	•	•	•	•	•	
S185210100	185.00	210.00	10.00	X	•	•	•	•	•	•	•	•	•	
S185210130	185.00	210.00	13.00	X	•	•	X	•	•	•	•	•	•	
S185215160	185.00	215.00	16.00	X	•	•	•	•	•	•	•	•	•	
S190212120	190.00	212.00	12.00	X	•	•	•	•	•	•	•	•	•	
S190215160	190.00	215.00	16.00	•	•	•	X	•	•	•	•	•	•	
S190220150	190.00	220.00	15.00	X	•	X	•	•	•	•	•	•	•	
S190225160	190.00	225.00	16.00	X	•	•	X	•	•	•	•	•	•	
S190230160	190.00	230.00	16.00	•	•	•	X	•	•	•	•	•	•	
S195220160	195.00	220.00	16.00	X	•	•	•	•	•	•	•	•	•	
S200222120	200.00	222.00	12.00	X	•	•	•	•	•	•	•	•	•	
S200225150	200.00	225.00	15.00	X	•	•	•	•	•	•	•	•	•	
S200230130	200.00	230.00	13.00	X	•	•	•	•	•	•	•	•	•	
S200230150	200.00	230.00	15.00	X	•	•	X	•	•	•	•	•	•	
S200250150	200.00	250.00	15.00	X	•	•	•	•	•	•	•	•	•	
S205230160	205.00	230.00	16.00	X	•	•	•	•	•	•	•	•	•	
S207240160	207.00	240.00	16.00	•	•	•	X	•	•	•	•	•	•	
S210232120	210.00	232.00	12.00	X	•	•	•	•	•	•	•	•	•	
S210240150	210.00	240.00	15.00	X	•	•	•	•	•	•	•	•	•	
S210250150	210.00	250.00	15.00	X	•	•	•	•	•	•	•	•	•	
S210290200	210.00	290.00	20.00	X	•	•	X	•	•	•	•	•	•	
S215240120	215.00	240.00	12.00	X	•	•	•	•	•	•	•	•	•	
S220250120	220.00	250.00	12.00	X	•	•	•	•	•	•	•	•	•	
S220250150	220.00	250.00	15.00	X	•	X	X	•	•	•	•	•	•	
S220255160	220.00	255.00	16.00	X	•	•	•	•	•	•	•	•	•	
S220260150	220.00	260.00	15.00	X	•	•	•	•	•	•	•	•	•	
S220260160	220.00	260.00	16.00	X	•	•	•	•	•	•	•	•	•	
S230260150	230.00	260.00	15.00	X	•	•	X	•	•	•	•	•	•	
S230280150	230.00	280.00	15.00	X	•	•	•	•	•	•	•	•	•	
S240270150	240.00	270.00	15.00	X	•	•	X	•	•	•	•	•	•	
S240275160	240.00	275.00	16.00	X	•	•	•	•	•	•	•	•	•	
S240280150	240.00	280.00	15.00	X	•	•	•	•	•	•	•	•	•	
S250280150	250.00	280.00	15.00	X	•	•	•	•	•	•	•	•	•	
S260290150	260.00	290.00	15.00	X	•	•	•	•	•	•	•	•	•	
S260290160	260.00	290.00	16.00	X	•	•	•	•	•	•	•	•	•	
S260300160	260.00	300.00	16.00	X	•	•	•	•	•	•	•	•	•	
S260300200	260.00	300.00	20.00	X	•	•	•	•	•	•	•	•	•	
S265290160	265.00	290.00	16.00	X	•	•	•	•	•	•	•	•	•	
S280310150	280.00	310.00	15.00	X	•	•	•	•	•	•	•	•	•	
S280320200	280.00	320.00	20.00	X	•	•	X	•	•	•	•	•	•	
S280350160	280.00	350.00	16.00	X	•	•	•	•	•	•	•	•	•	
S290330200	290.00	330.00	20.00	X	•	•	•	•	•	•	•	•	•	
S300340180	300.00	340.00	18.00	X	•	•	•	•	•	•	•	•	•	
S300340200	300.00	340.00	20.00	X	•	•	•	•	•	•	•	•	•	
S300344200	300.00	344.00	20.00	X	•	•	•	•	•	•	•	•	•	

X: EXISTING TOOLING •: ON REQUEST



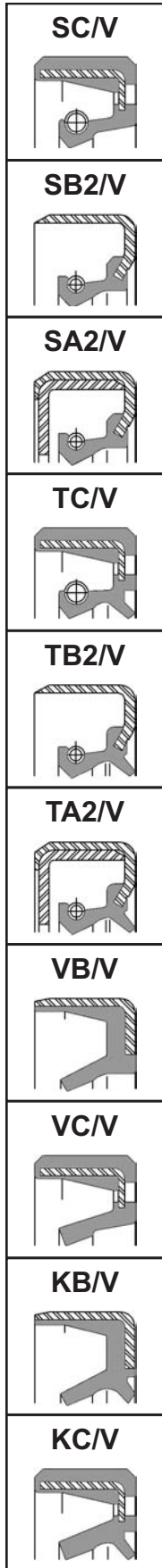





N.B.: MINIMUM LINE ORDER MAY APPLY

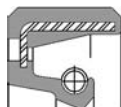

## GLOBAL AVAILABILITY LIST

## RADIAL SHAFT SEALS - FPM/STEEL

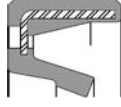
METRIC SIZE  
SHAFT SEALS

SC/V 	Ref. Number	Dimensions			DESIGN TYPE									
		d	D	H	SC/V	SB2/V	SA2/V	TC/V	TB2/V	TA2/V	VB/V	VC/V	KB/V	KC/V
	S310340150	310.00	340.00	15.00	•	•	•	X	•	•	•	•	•	•
	S320360180	320.00	360.00	18.00	X	•	•	•	•	•	•	•	•	•
	S320360200	320.00	360.00	20.00	X	•	•	•	•	•	•	•	•	•
	S330370180	330.00	370.00	18.00	X	•	•	•	•	•	•	•	•	•
	S340380180	340.00	380.00	18.00	X	•	•	•	•	•	•	•	•	•
	S350390180	350.00	390.00	18.00	X	•	•	•	•	•	•	•	•	•
	S360390150	360.00	390.00	15.00	•	•	•	X	•	•	•	•	•	•
	S360400180	360.00	400.00	18.00	X	•	•	•	•	•	•	•	•	•
	S360400200	360.00	400.00	20.00	•	•	•	X	•	•	•	•	•	•
	S370410150	370.00	410.00	15.00	X	•	•	•	•	•	•	•	•	•
	S380420200	380.00	420.00	20.00	X	•	•	X	•	•	•	•	•	•
	S390430200	390.00	430.00	20.00	X	•	•	•	•	•	•	•	•	•
	S394420160	394.00	420.00	16.00	X	•	•	X	•	•	•	•	•	•
	S400440200	400.00	440.00	20.00	X	•	•	•	•	•	•	•	•	•
	S420460200	420.00	460.00	20.00	X	•	•	•	•	•	•	•	•	•
	S420470200	420.00	470.00	20.00	•	•	•	X	•	•	•	•	•	•
	S440480200	440.00	480.00	20.00	X	•	•	X	•	•	•	•	•	•
	S450500220	450.00	500.00	22.00	X	•	•	X	•	•	•	•	•	•
	S480520200	480.00	520.00	20.00	X	•	•	X	•	•	•	•	•	•
	S500540200	500.00	540.00	20.00	X	•	•	X	•	•	•	•	•	•
	S500550220	500.00	550.00	22.00	X	•	•	•	•	•	•	•	•	•
														
														

X: EXISTING TOOLING    •: ON REQUEST

N.B.: MINIMUM LINE ORDER MAY APPLY

Tel.: (418) 688-3202  
Fax: (418) 688-4272

**SS 253**

[www.sealsonline.com](http://www.sealsonline.com)



## PRESSURE SEALS - NOK

### TB4

NOK Metal OD, Two stepped Main Lip Oil Seal with Auxiliary Dust Lip

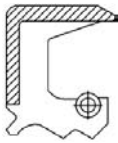

Severe reciprocating shaft applications can be effectively sealed by the "T4" design. Pressure up to 100 psi (7kg/cm<sup>2</sup>) can be sealed, such as in shock absorbers.

### TC4

NOK Rubber OD, Double Lip, Two Stepped Main Lip Oil Seal



Severe reciprocating shaft applications can be effectively sealed by the "T4" design. Pressure up to 100 psi (7kg/cm<sup>2</sup>) can be sealed, such as in shock absorbers.

### TCN

NOK Rubber OD, Double Lip, Pressure Seal



Type "TCN" is designed for high pressure applications where continuous pressure may reach 150 psi (10.6kg/cm<sup>2</sup>). Maximum pressure limit is dependent on shaft speed.

### TCV

NOK Rubber OD, Double Lip, Pressure Seal



Type "TCV" is designed for high pressure applications where continuous pressure may reach 50 psi (10.6kg/cm<sup>2</sup>). Maximum pressure limit is dependent on shaft speed.



## PRESSURE SEALS - SIMRIT

METRIC SIZE  
SHAFT SEALS

### **BABSL** SIMRIT Covered OD, Double lip, pressure oil seal

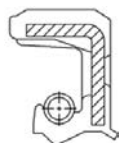

For sealing pressurized media without additional backup ring, e.g. for rotational pressure sealing in hydraulic pumps, hydraulic motors, hydrodynamic clutches. Rubber covered O.D. assures sealing in the housing bore, even where there is considerable surface roughness, thermal expansion or split housing. Particularly suitable for sealing low viscosity and gaseous media.

### **B2PT** SIMRIT Outer metal case, single PTFE sealing lip



For use in a range of special applications, particularly in general mechanical engineering and in the chemical industry; for high temperature requirements: dry running and poor lubrication; high chemical resistance; stick-slip free behavior; in extreme cases dynamic sealing behavior is partially limited.

### **BAD** SIMRIT Rubber OD

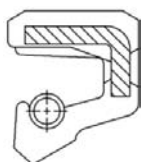

Older type for use in components with light pressure; now largely replaced by type BABSL.

### **B1D** SIMRIT Rubber OD



Older type for use in components with light pressure; now largely replaced by type BABSL.





# simrit®



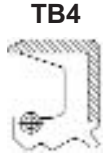
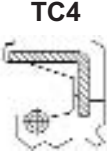
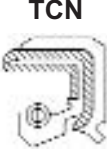
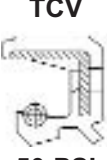

## PRESSURE SEALS - NOK/SIMRIT

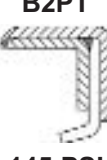
## NOK/SIMRIT AVAILABILITY LIST



Design Type	Dimensions			Lip Material	Design Type	Dimensions			Lip Material	 <p><b>TB4</b> 100 PSI</p>
	d	D	H			d	D	H		
TC4	6.00	16.00	6.50	FPM	BABSL	11.00	22.00	7.00	NBR	 <p><b>TC4</b> 100 PSI</p>
TC4	6.80	14.00	4.00	NBR	TC4	11.00	33.80	12.00	NBR	
TC4	7.00	16.00	7.00	NBR	TCV	12.00	19.00	4.50	NBR	 <p><b>TCN</b> 150 PSI</p>
TCV	7.00	20.00	7.00	FPM	BAD	12.00	19.00	5.00	NBR	
TCV	7.00	20.00	7.00	NBR	BABSL	12.00	22.00	6.00	FPM	 <p><b>TCV</b> 50 PSI</p>
TC4	7.00	40.00	9.00	NBR	BABSL	12.00	22.00	6.00	NBR	
TC4	8.00	16.00	6.00	FPM	BABSL	12.00	22.00	6.00	NBR	 <p><b>BABSL</b> 50 PSI</p>
TCV	8.00	16.00	6.00	ACM	B2PT	12.00	22.00	7.00	PTFE	
TC4	8.00	16.00	7.50	NBR	BABSL	12.00	22.00	7.00	NBR	 <p><b>B2PT</b> 145 PSI</p>
TC4	8.00	17.00	10.00	NBR	BAD	12.00	22.00	7.00	NBR	
TB4	8.00	18.00	7.00	NBR	TB4	12.00	22.00	7.00	NBR	 <p><b>BAD</b> 22 PSI</p>
TC4	8.00	18.00	7.00	NBR	TCV	12.00	22.00	7.00	ACM	
TCV	8.00	18.00	7.00	FPM	TCV	12.00	22.00	7.00	NBR	 <p><b>B1D</b> 22 PSI</p>
TCV	8.00	18.00	7.00	NBR	TC4	12.00	22.00	8.00	NBR	
TC4	8.00	19.50	10.00	NBR	TCV	12.00	23.00	6.00	FPM	
TC4	8.00	20.00	8.00	NBR	BABSL	12.00	24.00	6.00	NBR	
TC4	8.00	21.50	10.00	NBR	BABSL	12.00	24.00	6.00	FPM	
BABSL	8.00	22.00	6.00	FPM	TC4	12.00	24.00	7.00	NBR	
BABSL	8.00	22.00	6.00	NBR	B2PT	12.00	25.00	7.00	PTFE	
BABSL	8.00	22.00	7.00	NBR	TC4	12.00	25.00	7.00	NBR	
TCV	8.00	22.00	7.00	ACM	TCV	12.00	25.00	7.00	FPM	
TCV	8.00	22.00	7.00	FPM	TCV	12.00	25.00	7.00	NBR	
TCV	8.00	22.00	7.00	NBR	BAD	12.00	25.00	8.00	NBR	
BAD	8.00	22.00	8.00	NBR	BAD	12.00	30.00	12.00	NBR	
TC4	8.00	22.00	10.00	NBR	BABSL	12.00	32.00	7.00	NBR	
TC4	8.00	22.00	11.00	NBR	TC4	12.50	28.00	13.40	NBR	
BABSL	9.00	20.00	6.00	NBR	TC4	12.50	34.00	14.40	NBR	
TCV	9.00	22.00	7.00	NBR	TC4	12.50	36.00	12.00	NBR	
TC4	9.00	25.50	12.00	NBR	BAD	13.00	23.00	6.00	NBR	
BAD	10.00	20.00	6.00	NBR	TC4	13.00	25.00	7.00	NBR	
TC4	10.00	20.00	7.00	NBR	TCV	13.00	25.00	7.00	FPM	
TCV	10.00	20.00	7.00	NBR	TC4	13.00	26.00	9.00	NBR	
TC4	10.00	20.00	7.50	NBR	TCV	13.00	28.00	7.00	NBR	
TB4	10.00	20.00	9.50	NBR	TC4	14.00	24.00	6.50	ACM	
BABSL	10.00	22.00	6.00	NBR	BABSL	14.00	24.00	7.00	NBR	
BABSL	10.00	22.00	6.00	FPM	TB4	14.00	24.00	7.00	NBR	
B2PT	10.00	22.00	7.00	PTFE	TC4	14.00	24.00	7.00	NBR	
BABSL	10.00	22.00	7.00	NBR	TCV	14.00	24.00	7.00	ACM	
TB4	10.00	22.00	7.00	NBR	TCV	14.00	24.00	7.00	NBR	
TC4	10.00	22.00	7.00	FPM	TB4	14.00	25.00	7.00	ACM	
TCV	10.00	22.00	7.00	NBR	TB4	14.00	25.00	7.00	NBR	
TC4	10.00	22.00	11.00	NBR	TC4	14.00	25.00	7.00	NBR	
TCV	10.00	25.00	7.00	FPM	TCV	14.00	26.00	6.50	FPM	
TCV	10.00	25.00	7.00	NBR	TCV	14.00	28.00	7.00	NBR	
TC4	10.00	28.00	10.00	NBR	TC4	14.00	28.00	8.50	FPM	
TC4	10.00	28.00	13.40	NBR	B2PT	14.00	30.00	7.00	PTFE	
TC4	10.00	30.00	12.00	NBR	BAD	14.00	30.00	10.00	NBR	
TC4	10.00	40.00	9.00	NBR	TB4	14.00	30.00	10.00	ACM	

N.B.: MINIMUM LINE ORDER MAY APPLY

## NOK/SIMRIT AVAILABILITY LIST

## PRESSURE SEALS - NOK/SIMRIT

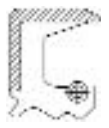
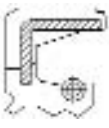
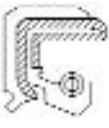
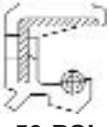
**METRIC SIZE  
SHAFT SEALS**

<b>TB4</b>  <b>100 PSI</b>	Design Type	Dimensions			Lip Material	Design Type	Dimensions			Lip Material
		d	D	H			d	D	H	
<b>TC4</b>  <b>100 PSI</b>	BABSL	15.00	25.00	6.00	FPM	TCV	17.00	30.00	8.00	FPM
	BABSL	15.00	25.00	6.00	NBR	TCV	17.00	30.00	8.00	NBR
	TC4	15.00	25.00	7.00	ACM	TCV	17.00	32.00	8.00	NBR
	TC4	15.00	25.00	7.00	NBR	B2PT	17.00	35.00	7.00	PTFE
	BAD	15.00	26.00	7.00	NBR	BABSL	17.00	35.00	7.00	NBR
	BAD	15.00	27.00	7.00	NBR	TCV	17.00	35.00	7.00	NBR
	B2PT	15.00	30.00	7.00	PTFE	TCV	17.00	35.00	8.00	NBR
	TCV	15.00	30.00	7.00	FPM	BAD	17.00	35.00	10.00	NBR
	TCV	15.00	30.00	7.00	NBR	TB4	17.00	38.00	7.00	NBR
	B1D	15.00	30.00	10.00	NBR	BAD	17.00	40.00	6.00	NBR
<b>TCN</b>  <b>150 PSI</b>	TB4	15.00	30.00	10.00	NBR	BAD	17.00	40.00	8.50	NBR
	B2PT	15.00	32.00	7.00	PTFE	TCN	17.46	28.55	7.10	FPM
	BABSL	15.00	32.00	7.00	NBR	TCV	17.46	30.15	8.00	NBR
	BABSL	15.00	35.00	6.00	NBR	TC4	18.00	26.00	7.00	NBR
	BABSL	15.00	35.00	6.00	FPM	TC4	18.00	28.00	7.00	NBR
	TCV	15.00	35.00	6.00	FPM	BABSL	18.00	30.00	6.00	NBR
	TC4	15.00	45.50	12.00	NBR	BABSL	18.00	30.00	6.00	NBR
	TC4	16.00	24.00	7.00	NBR	TCV	18.00	30.00	6.00	NBR
	TC4	16.00	26.00	6.00	NBR	BABSL	18.00	30.00	7.00	NBR
	B1D	16.00	26.00	7.00	NBR	TCV	18.00	30.00	7.00	ACM
<b>TCV</b>  <b>50 PSI</b>	BABSL	16.00	26.00	7.00	NBR	TCV	18.00	30.00	7.00	NBR
	BAD	16.00	26.00	7.00	NBR	TCV	18.00	30.00	7.50	ACM
	TC4	16.00	26.00	7.00	ACM	TB4	18.00	30.00	8.00	NBR
	TC4	16.00	26.00	7.00	NBR	TC4	18.00	30.00	8.00	NBR
	TCV	16.00	26.00	7.00	FPM	TCV	18.00	30.00	8.00	FPM
	TB4	16.00	28.00	7.00	FPM	TCV	18.00	30.00	8.00	NBR
	TC4	16.00	28.00	7.00	NBR	TC4	18.00	30.00	9.00	NBR
	TCV	16.00	28.00	7.00	NBR	BABSL	18.00	32.00	6.00	NBR
	TCV	16.00	30.00	4.50	NBR	B2PT	18.00	32.00	7.00	PTFE
	TB4	16.00	30.00	7.00	ACM	TC4	18.00	32.00	8.00	NBR
<b>B2PT</b>  <b>145 PSI</b>	TB4	16.00	30.00	7.00	NBR	BABSL	18.00	35.00	6.00	NBR
	TCV	16.00	30.00	7.00	FPM	BABSL	18.00	35.00	6.00	FPM
	TCV	16.00	30.00	7.00	NBR	TB4	18.00	35.00	8.00	ACM
	TCV	16.00	30.00	7.00	Silicone	TCV	18.00	35.00	8.00	FPM
	TB4	16.00	32.00	7.00	NBR	TCV	18.00	35.00	8.00	NBR
	TC4	16.00	32.00	10.00	NBR	BAD	18.00	35.00	10.00	NBR
	B2PT	16.00	35.00	7.00	PTFE	TC4	18.00	35.00	11.00	ACM
	BAD	16.00	35.00	9.00	NBR	TC4	18.00	35.00	11.00	NBR
	BABSL	16.00	40.00	10.00	FPM	TCN	18.00	38.00	11.00	FPM
	TCV	17.00	28.00	6.00	FPM	TB4	19.00	30.00	8.00	NBR
<b>BAD</b>  <b>22 PSI</b>	BABSL	17.00	30.00	6.00	NBR	TC4	19.00	32.00	6.00	HNBR
	BABSL	17.00	30.00	6.00	FPM	TCV	19.00	32.00	8.00	NBR
	TCV	17.00	30.00	6.50	ACM	BABSL	19.00	35.00	6.00	FPM
	BAD	17.00	30.00	7.00	NBR	TB4	19.00	35.00	8.00	NBR
	TCV	17.00	30.00	7.00	ACM	TCV	19.00	35.00	8.00	FPM
	TCV	17.00	30.00	7.00	FPM	TCV	19.00	35.00	8.00	NBR
	TCV	17.00	30.00	7.00	NBR	BABSL	19.05	31.75	6.35	NBR
	TCV	17.00	30.00	7.00	T945	TCV	20.00	30.00	4.50	FPM

N.B.: MINIMUM LINE ORDER MAY APPLY

Tel.: (888) 238-5885  
Fax: (888) 238-1664

**SS 257**

[www.sealsonline.com](http://www.sealsonline.com)



## PRESSURE SEALS - NOK/SIMRIT

## NOK/SIMRIT AVAILABILITY LIST

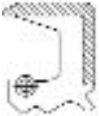
Design Type	Dimensions			Lip Material	Design Type	Dimensions			Lip Material	<b>TB4</b>  <b>100 PSI</b>
	d	D	H			d	D	H		
TCV	20.00	30.00	4.50	NBR	TCV	21.00	32.00	8.00	NBR	
B2PT	20.00	30.00	7.00	PTFE	TCV	21.00	40.00	7.00	NBR	
BABSL	20.00	30.00	7.00	NBR	BABSL	22.00	32.00	6.00	NBR	
BAD	20.00	30.00	7.00	NBR	BABSL	22.00	32.00	6.00	FPM	
TCV	20.00	30.00	7.00	ACM	TCV	22.00	32.00	6.00	ACM	
TCV	20.00	30.00	7.00	FPM	B1D	22.00	32.00	7.00	NBR	
TCV	20.00	30.00	7.00	NBR	BABSL	22.00	32.00	7.00	NBR	
TCV	20.00	32.00	6.50	FPM	BAD	22.00	32.00	7.00	NBR	
TCV	20.00	32.00	6.50	NBR	TCV	22.00	32.00	7.00	FPM	
B2PT	20.00	32.00	7.00	PTFE	TC4	22.00	32.00	8.00	NBR	
BABSL	20.00	32.00	7.00	NBR	TCV	22.00	34.00	7.00	ACM	
BAD	20.00	32.00	7.00	NBR	BABSL	22.00	35.00	6.00	FPM	
TCV	20.00	32.00	8.00	FPM	BABSL	22.00	35.00	6.00	NBR	
TCV	20.00	32.00	8.00	NBR	TCV	22.00	35.00	6.00	NBR	
TC4	20.00	32.00	8.50	NBR	TC4	22.00	35.00	8.00	NBR	
TCV	20.00	34.00	7.00	NBR	TCV	22.00	35.00	8.00	FPM	
BABSL	20.00	35.00	6.00	NBR	TCV	22.00	35.00	8.00	NBR	
BABSL	20.00	35.00	6.00	FPM	TB4	22.00	35.00	10.00	NBR	
B2PT	20.00	35.00	7.00	PTFE	TCV	22.00	36.00	7.00	FPM	
TB4	20.00	35.00	7.00	NBR	TCV	22.00	36.00	7.00	NBR	
TC4	20.00	35.00	7.00	ACM	TCV	22.00	36.00	10.00	NBR	
TC4	20.00	35.00	7.00	FPM	TC4	22.00	37.00	8.00	FPM	
TC4	20.00	35.00	7.00	NBR	TB4	22.00	38.00	8.00	NBR	
TCV	20.00	35.00	7.00	ACM	TC4	22.00	38.00	8.00	NBR	
B1D	20.00	35.00	8.00	NBR	TCV	22.00	38.00	8.00	NBR	
TB4	20.00	35.00	8.00	NBR	TC4	22.00	38.00	9.00	NBR	
TCN	20.00	35.00	8.00	NBR	B1D	22.00	40.00	8.00	NBR	
TCV	20.00	35.00	8.00	FPM	BAD	22.00	40.00	9.00	NBR	
TCV	20.00	35.00	8.00	NBR	TC4	22.00	40.00	9.00	NBR	
TB4	20.00	35.00	10.00	NBR	TC4	22.00	40.00	10.00	NBR	
TCV	20.00	36.00	7.00	ACM	TB4	22.00	42.00	10.00	ACM	
B1D	20.00	40.00	7.00	NBR	TB4	22.00	42.00	11.00	NBR	
B2PT	20.00	40.00	7.00	PTFE	TCN	22.00	42.00	11.00	NBR	
BAD	20.00	40.00	7.00	NBR	TCV	22.00	42.00	11.00	FPM	
TCV	20.00	40.00	7.00	ACM	TCV	22.00	42.00	11.00	NBR	
TCV	20.00	40.00	7.00	NBR	TCV	23.00	42.00	8.00	FPM	
BAD	20.00	40.00	8.00	NBR	TCV	23.00	42.00	11.00	NBR	
BAD	20.00	40.00	10.00	NBR	TCV	24.00	35.00	6.00	NBR	
TB4	20.00	40.00	10.00	ACM	TCV	24.00	36.00	7.00	NBR	
TB4	20.00	40.00	10.00	NBR	TCN	24.00	38.00	7.00	FPM	
TC4	20.00	40.00	10.00	NBR	TCN	24.00	38.00	7.00	NBR	
TCV	20.00	40.00	10.00	NBR	BABSL	24.00	40.00	7.00	NBR	
TCN	20.00	40.00	11.00	FPM	TCV	24.00	40.00	7.00	NBR	
TCN	20.00	40.00	11.00	NBR	TB4	24.00	40.00	8.00	NBR	
TCV	20.00	40.00	11.00	FPM	TCV	24.00	40.00	8.00	ACM	
TCV	20.00	40.00	11.00	NBR	TCV	24.00	40.00	8.00	FPM	
TCV	20.00	42.00	8.00	NBR	TCV	24.00	40.00	8.00	NBR	
B2PT	20.00	47.00	7.00	PTFE	TB4	24.00	44.00	10.00	ACM	

N.B.: MINIMUM LINE ORDER MAY APPLY

**METRIC SIZE  
SHAFT SEALS**







**M**

## NOK/SIMRIT AVAILABILITY LIST

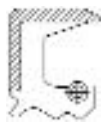
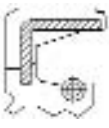
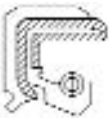
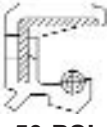
## PRESSURE SEALS - NOK/SIMRIT

**METRIC SIZE  
SHAFT SEALS**

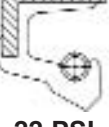
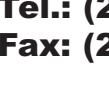
<b>TB4</b>  <b>100 PSI</b>	Design Type	Dimensions			Lip Material	Design Type	Dimensions			Lip Material
		d	D	H			d	D	H	
<b>TC4</b>  <b>100 PSI</b>	TC4	25.00	33.00	8.00	NBR	TCV	25.00	52.00	8.00	NBR
	BABSL	25.00	35.00	6.00	NBR	TCV	25.00	52.00	10.00	NBR
	BABSL	25.00	35.00	6.00	NBR	TB4	26.00	36.00	10.50	NBR
	TCV	25.00	35.00	6.00	FPM	TC4	26.00	37.00	10.50	NBR
	TCV	25.00	35.00	6.00	NBR	TC4	26.00	38.00	8.00	NBR
	BAD	25.00	35.00	7.00	NBR	TC4	26.00	38.00	9.00	NBR
<b>TCN</b>  <b>150 PSI</b>	BABSL	25.00	36.00	6.00	NBR	BABSL	26.00	40.00	6.00	FPM
	BABSL	25.00	37.00	6.00	NBR	TCV	26.00	40.00	9.00	FPM
	TCV	25.00	37.00	6.50	NBR	TCV	26.00	40.00	9.00	NBR
	TCV	25.00	38.00	6.00	FPM	TCV	26.00	40.00	9.00	Silicone
	B2PT	25.00	38.00	7.00	PTFE	TC4	26.00	42.00	8.00	NBR
	BAD	25.00	38.00	7.00	NBR	TCV	26.00	42.00	8.00	FPM
<b>TCV</b>  <b>50 PSI</b>	TC4	25.00	38.00	7.00	NBR	TCV	26.00	42.00	8.00	NBR
	TCV	25.00	38.00	7.00	NBR	TB4	27.00	39.00	10.50	NBR
	TCV	25.00	38.00	8.00	NBR	TC4	27.00	39.00	10.50	NBR
	TC4	25.00	38.00	10.00	NBR	BAD	27.00	41.00	10.00	NBR
	B2PT	25.00	40.00	7.00	PTFE	TCV	27.00	47.00	11.00	NBR
	BABSL	25.00	40.00	7.00	NBR	TC4	28.00	39.00	8.00	NBR
<b>BABSL</b>  <b>50 PSI</b>	TCV	25.00	40.00	7.00	FPM	BABSL	28.00	40.00	6.00	FPM
	TB4	25.00	40.00	8.00	ACM	BABSL	28.00	40.00	6.00	NBR
	TB4	25.00	40.00	8.00	NBR	BABSL	28.00	40.00	8.00	NBR
	TC4	25.00	40.00	8.00	ACM	BABSL	28.00	40.00	8.00	FPM
	TC4	25.00	40.00	8.00	NBR	TCV	28.00	40.00	8.00	FPM
	TCV	25.00	40.00	8.00	FPM	TCV	28.00	40.00	8.00	NBR
<b>B2PT</b>  <b>145 PSI</b>	TCV	25.00	40.00	8.00	NBR	BABSL	28.00	40.00	9.00	NBR
	BABSL	25.00	42.00	6.00	NBR	TC4	28.00	40.00	9.00	NBR
	B2PT	25.00	42.00	7.00	PTFE	TB4	28.00	40.00	10.50	NBR
	TCV	25.00	42.00	8.00	NBR	TB4	28.00	41.00	10.50	NBR
	B1D	25.00	42.00	10.00	NBR	BAD	28.00	43.00	10.00	NBR
	BAD	25.00	42.00	10.00	NBR	TC4	28.00	45.00	7.00	FPM
<b>BAD</b>  <b>22 PSI</b>	BAD	25.00	43.00	10.00	NBR	TB4	28.00	45.00	8.00	NBR
	TCV	25.00	45.00	7.00	FPM	TC4	28.00	45.00	8.00	NBR
	TCV	25.00	45.00	8.00	NBR	B2PT	28.00	47.00	7.00	PTFE
	TB4	25.00	45.00	10.00	ACM	TC4	28.00	47.00	8.00	FPM
	TB4	25.00	45.00	10.00	NBR	BAD	28.00	47.00	9.00	NBR
	TCN	25.00	45.00	11.00	FPM	TB4	28.00	48.00	11.00	NBR
<b>B1D</b>  <b>22 PSI</b>	TCN	25.00	45.00	11.00	NBR	TCN	28.00	48.00	11.00	FPM
	TCV	25.00	45.00	11.00	FPM	TCN	28.00	48.00	11.00	NBR
	TCV	25.00	45.00	11.00	NBR	TCV	28.00	48.00	11.00	FPM
	TCN	25.00	45.00	12.50	NBR	TCV	28.00	48.00	11.00	NBR
	BABSL	25.00	47.00	6.00	NBR	TCN	28.00	48.00	12.00	NBR
	BABSL	25.00	47.00	6.00	FPM	BAD	28.00	50.00	10.00	NBR
<b>B2PT</b>  <b>22 PSI</b>	TCV	25.00	47.00	6.00	NBR	TCV	28.00	52.00	7.00	FPM
	B2PT	25.00	47.00	7.00	PTFE	TCV	28.58	44.61	7.00	NBR
	BAD	25.00	47.00	8.00	NBR	TCV	28.58	50.75	6.40	FPM
	BAD	25.00	47.00	10.00	NBR	TCV	28.58	53.98	7.00	NBR
	B2PT	25.00	52.00	7.00	PTFE	TCV	29.00	41.00	7.00	ACM
	BAD	25.00	52.00	8.00	NBR	TCV	29.00	41.00	7.00	FPM

N.B.: MINIMUM LINE ORDER MAY APPLY

Tel.: (204) 783-9617  
Fax: (204) 783-6091







**SS 259**

[www.sealsonline.com](http://www.sealsonline.com)

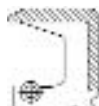
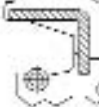

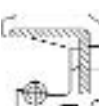
## PRESSURE SEALS - NOK/SIMRIT

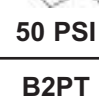
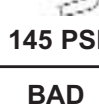
## NOK/SIMRIT AVAILABILITY LIST



Design Type	Dimensions			Lip Material	Design Type	Dimensions			Lip Material	TB4  100 PSI
	d	D	H			d	D	H		
TCV	29.00	41.00	7.00	NBR	BABSL	32.00	44.00	8.00	NBR	
TCV	29.00	47.00	9.00	FPM	TCV	32.00	44.00	8.00	NBR	
TCV	29.00	47.00	9.00	NBR	TC4	32.00	44.00	10.00	NBR	
TC4	29.80	40.00	7.00	NBR	TC4	32.00	45.00	8.00	NBR	
B2PT	30.00	40.00	7.00	PTFE	TCV	32.00	46.00	8.00	FPM	TC4  100 PSI
TB4	30.00	40.50	10.50	NBR	TCV	32.00	46.00	8.00	NBR	
TC4	30.00	40.50	10.50	NBR	BABSL	32.00	47.00	6.00	NBR	
BABSL	30.00	42.00	6.00	NBR	BABSL	32.00	47.00	6.00	FPM	
BABSL	30.00	42.00	6.00	FPM	B2PT	32.00	47.00	8.00	PTFE	TCN  150 PSI
BABSL	30.00	42.00	7.00	NBR	TC4	32.00	48.00	8.00	NBR	
TCV	30.00	42.00	7.00	NBR	TCV	32.00	48.00	8.00	FPM	
TB4	30.00	42.00	8.00	NBR	TB4	32.00	50.00	10.00	NBR	
TC4	30.00	42.00	8.00	NBR	TCV	32.00	50.00	10.00	NBR	TCV  50 PSI
TCV	30.00	42.00	8.00	NBR	BABSL	32.00	52.00	6.00	NBR	
TC4	30.00	42.00	10.50	NBR	B1D	32.00	52.00	8.00	NBR	
TC4	30.00	42.00	11.00	NBR	TCV	32.00	52.00	8.00	NBR	
TB4	30.00	42.00	12.00	NBR	TCV	32.00	52.00	9.00	FPM	TCN  50 PSI
TCV	30.00	44.00	8.00	NBR	TCV	32.00	52.00	9.00	NBR	
B2PT	30.00	45.00	7.00	PTFE	TB4	32.00	52.00	11.00	NBR	
TCV	30.00	45.00	8.00	FPM	TCN	32.00	52.00	11.00	FPM	
TCV	30.00	45.00	8.00	NBR	TCN	32.00	52.00	11.00	NBR	BABSL  50 PSI
TCN	30.00	45.00	10.50	FPM	TCV	32.00	52.00	11.00	FPM	
TCN	30.00	45.00	10.50	NBR	TCV	32.00	52.00	11.00	NBR	
B2PT	30.00	47.00	7.00	PTFE	TCN	32.00	52.00	13.00	NBR	
TB4	30.00	48.00	11.00	NBR	TB4	33.00	44.00	12.00	NBR	B2PT  145 PSI
B2PT	30.00	50.00	7.00	PTFE	TC4	33.00	45.00	10.00	NBR	
TC4	30.00	50.00	9.00	ACM	TCV	33.00	50.00	11.00	FPM	
BAD	30.00	50.00	10.00	NBR	TCV	33.00	50.00	11.00	NBR	
TB4	30.00	50.00	11.00	NBR	B1D	34.00	45.00	7.00	NBR	BAD  22 PSI
TC4	30.00	50.00	11.00	NBR	TB4	34.00	46.00	10.50	NBR	
TCN	30.00	50.00	11.00	FPM	TC4	34.00	48.00	9.00	HNBR	
TCN	30.00	50.00	11.00	NBR	TC4	34.00	48.00	11.50	HNBR	
TCV	30.00	50.00	11.00	FPM	TC4	34.00	48.00	11.50	NBR	B1D  22 PSI
TCV	30.00	50.00	11.00	NBR	TB4	34.00	48.00	12.00	NBR	
TCN	30.00	50.00	12.00	FPM	TC4	34.00	48.00	12.00	NBR	
TCN	30.00	50.00	12.00	NBR	TB4	34.00	54.00	11.00	NBR	
TCN	30.00	50.00	12.50	NBR	TCN	34.00	54.00	11.00	NBR	
BABSL	30.00	52.00	7.00	NBR	TCV	34.00	54.00	11.00	NBR	
TCV	30.00	52.00	7.00	NBR	TCN	34.00	54.00	12.00	FPM	
BAD	30.00	72.00	10.00	NBR	TCN	34.00	54.00	12.00	NBR	
TC4	31.00	41.00	9.00	NBR	BABSL	35.00	47.00	6.00	FPM	
TC4	31.00	43.00	10.00	NBR	BABSL	35.00	47.00	6.00	NBR	
TB4	31.00	43.00	10.70	NBR	BAD	35.00	47.00	7.00	NBR	
TCN	31.00	51.00	11.00	NBR	B2PT	35.00	47.00	8.00	PTFE	
TCV	31.00	51.00	11.00	ACM	TCV	35.00	47.00	8.00	NBR	
TCV	31.50	45.00	8.00	NBR	TCV	35.00	47.00	9.00	FPM	
BABSL	31.75	44.45	6.35	NBR	TB4	35.00	47.00	10.00	NBR	
TCV	32.00	42.00	7.00	NBR	TB4	35.00	47.00	10.50	NBR	

N.B.: MINIMUM LINE ORDER MAY APPLY

## NOK/SIMRIT AVAILABILITY LIST

## PRESSURE SEALS - NOK/SIMRIT

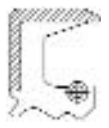
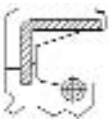
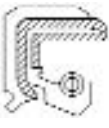
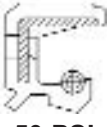
**METRIC SIZE  
SHAFT SEALS**

<b>TB4</b>  <b>100 PSI</b>	Design Type	Dimensions			Lip Material	Design Type	Dimensions			Lip Material
		d	D	H			d	D	H	
<b>TC4</b>  <b>100 PSI</b>	TCV	35.00	48.00	7.00	ACM	TB4	38.10	52.00	10.50	FPM
	TB4	35.00	48.00	8.00	NBR	BABSL	38.10	57.15	7.93	NBR
	TB4	35.00	48.00	9.00	NBR	TB4	40.00	50.00	9.00	NBR
	TB4	35.00	48.00	10.00	NBR	TCV	40.00	52.00	5.00	NBR
	BABSL	35.00	50.00	7.00	NBR	BABSL	40.00	52.00	7.00	NBR
	B2PT	35.00	50.00	8.00	PTFE	BAD	40.00	52.00	7.00	NBR
	TB4	35.00	50.00	8.00	NBR	TCV	40.00	52.00	7.00	FPM
	TCV	35.00	50.00	8.00	FPM	B2PT	40.00	52.00	8.00	PTFE
	TB4	35.00	50.00	10.00	NBR	TCV	40.00	52.00	8.00	NBR
	BABSL	35.00	52.00	6.00	NBR	BABSL	40.00	55.00	6.00	NBR
<b>TCN</b>  <b>150 PSI</b>	BABSL	35.00	52.00	6.00	FPM	B2PT	40.00	55.00	8.00	PTFE
	TCV	35.00	52.00	7.00	NBR	BABSL	40.00	55.00	8.00	NBR
	B2PT	35.00	52.00	8.00	PTFE	TB4	40.00	55.00	8.00	NBR
	TCV	35.00	52.00	8.00	ACM	TB4	40.00	55.00	9.00	NBR
	TCN	35.00	52.00	10.00	NBR	TC4	40.00	55.00	9.00	NBR
	TB4	35.00	52.00	12.00	NBR	BABSL	40.00	56.00	6.00	NBR
	B2PT	35.00	55.00	8.00	PTFE	TC4	40.00	56.00	10.00	NBR
	BABSL	35.00	55.00	11.00	NBR	BABSL	40.00	58.00	8.00	FPM
	TB4	35.00	55.00	11.00	NBR	TCV	40.00	58.00	8.00	ACM
	TCN	35.00	55.00	11.00	FPM	TCV	40.00	58.00	9.00	ACM
<b>TCV</b>  <b>50 PSI</b>	TCN	35.00	55.00	11.00	NBR	B2PT	40.00	60.00	8.00	PTFE
	TCV	35.00	55.00	11.00	FPM	TCV	40.00	60.00	8.00	FPM
	TCV	35.00	55.00	11.00	NBR	TCN	40.00	60.00	12.00	NBR
	TCN	35.00	55.00	12.00	NBR	BABSL	40.00	62.00	6.00	NBR
	TCN	35.00	55.00	13.00	NBR	BABSL	40.00	62.00	6.00	FPM
	TB4	35.00	57.00	12.00	NBR	BABSL	40.00	62.00	6.00	NBR
	TCN	35.00	60.00	15.00	NBR	B2PT	40.00	62.00	8.00	PTFE
	B2PT	35.00	62.00	8.00	PTFE	TCV	40.00	62.00	8.00	FPM
	BAD	35.00	62.00	10.00	NBR	TCV	40.00	62.00	8.00	NBR
	TCN	35.00	62.00	12.00	NBR	BAD	40.00	62.00	10.00	NBR
<b>B2PT</b>  <b>145 PSI</b>	TCN	36.00	48.00	10.50	NBR	TCN	40.00	62.00	11.00	FPM
	TB4	36.00	48.00	10.50	NBR	TCN	40.00	62.00	11.00	NBR
	TCV	36.00	50.00	7.00	NBR	TCV	40.00	62.00	11.00	FPM
	TCV	36.00	50.00	8.00	NBR	TCV	40.00	62.00	11.00	NBR
	TB4	36.00	50.00	10.00	NBR	TCV	40.00	62.00	11.00	NBR
	TB4	36.00	52.00	11.00	NBR	B1D	40.00	62.00	12.00	NBR
	TCV	36.00	58.00	12.00	NBR	TB4	40.00	62.00	12.00	NBR
	TC4	38.00	50.00	8.00	NBR	TC4	40.00	62.00	12.00	NBR
	TC4	38.00	50.00	10.00	NBR	TCN	40.00	62.00	12.00	FPM
	TC4	38.00	52.00	9.00	NBR	TCN	40.00	62.00	12.00	NBR
<b>BAD</b>  <b>22 PSI</b>	B2PT	38.00	55.00	8.00	PTFE	TB4	40.00	65.00	14.00	NBR
	TC4	38.00	55.00	8.00	NBR	TC4	41.00	53.00	10.00	NBR
	TCV	38.00	55.00	8.00	FPM	TC4	41.00	53.00	11.00	NBR
	TCN	38.00	58.00	11.00	FPM	TC4	41.00	54.00	11.00	NBR
	TCN	38.00	58.00	11.00	NBR	BAD	41.00	56.00	10.00	NBR
	TCV	38.00	58.00	11.00	FPM	B2PT	42.00	55.00	8.00	PTFE
	TCV	38.00	58.00	11.00	NBR	TCV	42.00	60.00	9.00	NBR
	TB4	38.00	60.00	12.00	NBR	BABSL	42.00	62.00	7.00	NBR

N.B.: MINIMUM LINE ORDER MAY APPLY

Tel.: (780) 414-1871  
Fax: (780) 487-5419







**SS 261**

[www.sealsonline.com](http://www.sealsonline.com)

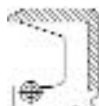
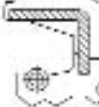

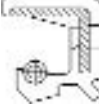
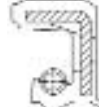
## PRESSURE SEALS - NOK/SIMRIT

## NOK/SIMRIT AVAILABILITY LIST





Design Type	Dimensions			Lip Material	Design Type	Dimensions			Lip Material	<b>TB4</b>  <b>100 PSI</b>
	d	D	H			d	D	H		
TCN	42.00	65.00	11.00	NBR	TCV	47.00	80.00	12.00	FPM	
TCN	42.00	65.00	12.00	NBR	TCV	48.00	62.00	9.00	FPM	
TCV	42.00	65.00	12.00	FPM	TCV	48.00	62.00	9.00	NBR	
TCV	42.00	65.00	12.00	NBR	BAD	48.00	65.00	8.00	NBR	
TC4	43.00	54.00	11.00	NBR	TB4	48.00	70.00	12.00	NBR	<b>TC4</b>  <b>100 PSI</b>
TC4	43.00	55.00	10.00	NBR	TC4	48.00	70.00	12.00	NBR	
BABSL	45.00	58.00	7.00	NBR	TCN	48.00	70.00	12.00	NBR	
BAD	45.00	60.00	7.00	NBR	TCV	48.00	70.00	12.00	NBR	
B2PT	45.00	60.00	8.00	PTFE	TCN	48.00	70.00	14.00	FPM	
TB4	45.00	60.00	9.00	ACM	TCN	48.00	70.00	14.00	NBR	
TB4	45.00	60.00	9.00	NBR	TC4	49.00	68.00	9.00	NBR	<b>TCN</b>  <b>150 PSI</b>
TC4	45.00	60.00	9.00	NBR	B2PT	50.00	62.00	8.00	PTFE	
TB4	45.00	60.00	10.00	NBR	TB4	50.00	64.00	8.00	NBR	
TC4	45.00	61.00	9.00	NBR	TB4	50.00	64.00	10.00	FPM	
B1D	45.00	62.00	7.00	NBR	TC4	50.00	64.00	10.00	NBR	
BABSL	45.00	62.00	7.00	NBR	BABSL	50.00	65.00	7.00	NBR	
BABSL	45.00	62.00	7.00	NBR	BABSL	50.00	65.00	7.00	FPM	<b>TCV</b>  <b>50 PSI</b>
BABSL	45.00	62.00	7.00	FPM	BABSL	50.00	65.00	8.00	NBR	
BAD	45.00	62.00	7.50	NBR	TCV	50.00	65.00	9.00	FPM	
B2PT	45.00	62.00	8.00	PTFE	BABSL	50.00	68.00	7.00	NBR	
TCV	45.00	62.00	8.00	FPM	BABSL	50.00	68.00	7.00	FPM	
TCV	45.00	62.00	9.00	FPM	B2PT	50.00	68.00	8.00	PTFE	
TCV	45.00	62.00	9.00	NBR	BABSL	50.00	68.00	8.00	NBR	<b>BABSL</b>  <b>50 PSI</b>
TCV	45.00	62.00	10.00	FPM	TCV	50.00	68.00	8.50	FPM	
TCV	45.00	62.00	10.00	NBR	TC4	50.00	68.00	9.00	NBR	
BAD	45.00	62.00	12.00	NBR	TCV	50.00	68.00	9.00	NBR	
TCN	45.00	62.00	12.00	FPM	TCN	50.00	68.00	12.00	FPM	
TCN	45.00	62.00	12.00	NBR	TCN	50.00	68.00	12.00	NBR	
BABSL	45.00	65.00	7.00	NBR	TCV	50.00	68.00	12.00	NBR	<b>B2PT</b>  <b>145 PSI</b>
TCV	45.00	65.00	7.00	NBR	B2PT	50.00	70.00	8.00	PTFE	
B2PT	45.00	65.00	8.00	PTFE	BABSL	50.00	70.00	10.00	NBR	
BABSL	45.00	65.00	8.00	NBR	TC4	50.00	70.00	10.50	NBR	
TCN	45.00	65.00	10.00	NBR	TCV	50.00	70.00	12.00	FPM	
TCV	45.00	65.00	10.00	FPM	BABSL	50.00	72.00	7.00	NBR	
TCN	45.00	65.00	12.00	FPM	BABSL	50.00	72.00	7.00	FPM	<b>BAD</b>  <b>22 PSI</b>
TCN	45.00	65.00	12.00	NBR	TCV	50.00	72.00	7.00	NBR	
TB4	45.00	68.00	12.00	NBR	B2PT	50.00	72.00	8.00	PTFE	
TC4	45.00	68.00	12.00	NBR	BAD	50.00	72.00	10.00	NBR	
TCN	45.00	68.00	12.00	FPM	TB4	50.00	72.00	12.00	NBR	
TCN	45.00	68.00	12.00	NBR	TC4	50.00	72.00	12.00	NBR	
TCN	45.00	68.00	12.00	PNBR	TCN	50.00	72.00	12.00	FPM	<b>B1D</b>  <b>22 PSI</b>
TCV	45.00	68.00	12.00	FPM	TCN	50.00	72.00	12.00	NBR	
TCV	45.00	68.00	12.00	NBR	TCV	50.00	72.00	12.00	FPM	
TB4	45.00	70.00	14.00	NBR	TCV	50.00	72.00	12.00	NBR	
B1D	45.00	72.00	12.00	NBR	TB4	50.00	72.00	14.00	NBR	
TCV	46.00	64.00	10.00	NBR	B2PT	52.00	72.00	8.00	PTFE	
TC4	47.00	58.00	10.00	NBR	BAD	52.00	72.00	12.00	NBR	
BABSL	47.00	62.00	7.00	NBR	TCN	52.00	75.00	9.00	FPM	

N.B.: MINIMUM LINE ORDER MAY APPLY

## NOK/SIMRIT AVAILABILITY LIST

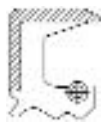
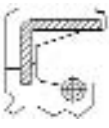
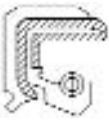
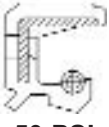
## PRESSURE SEALS - NOK/SIMRIT

**METRIC SIZE  
SHAFT SEALS**

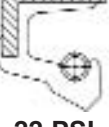
<b>TB4</b>  <b>100 PSI</b>	Design Type	Dimensions			Lip Material	Design Type	Dimensions			Lip Material
		d	D	H			d	D	H	
<b>TC4</b>  <b>100 PSI</b>	TCN	52.00	75.00	9.00	NBR	BABSL	60.00	80.00	7.00	FPM
	TB4	52.00	75.00	12.00	FPM	TCV	60.00	80.00	7.00	NBR
	TB4	52.00	75.00	12.00	NBR	B2PT	60.00	80.00	8.00	PTFE
	TCN	52.00	75.00	12.00	FPM	B1D	60.00	80.00	13.00	NBR
	TCN	52.00	75.00	12.00	NBR	TCV	60.00	80.00	14.00	FPM
	TCV	52.00	75.00	12.00	FPM	TCN	60.00	82.00	8.00	NBR
	TCV	52.00	75.00	12.00	NBR	TB4	60.00	82.00	12.00	NBR
	B1D	52.00	80.00	13.00	NBR	TCN	60.00	82.00	12.00	FPM
<b>TCN</b>  <b>150 PSI</b>	TC4	53.00	68.00	8.00	NBR	TCN	60.00	82.00	12.00	NBR
	BAD	54.00	70.00	10.00	NBR	TCV	60.00	82.00	12.00	NBR
	TB4	55.00	69.00	8.00	NBR	TB4	60.00	82.00	14.00	NBR
	BABSL	55.00	70.00	7.00	NBR	TCN	60.00	82.00	14.00	NBR
	B2PT	55.00	70.00	8.00	PTFE	BABSL	60.00	85.00	8.00	NBR
	BABSL	55.00	70.00	8.00	NBR	TB4	60.00	85.00	14.00	NBR
	BABSL	55.00	72.00	7.00	FPM	BABSL	62.00	85.00	7.00	NBR
	BABSL	55.00	72.00	7.00	NBR	BABSL	62.00	85.00	7.00	FPM
<b>TCV</b>  <b>50 PSI</b>	TCV	55.00	72.00	7.00	NBR	TB4	62.00	85.00	12.00	NBR
	BABSL	55.00	72.00	8.00	NBR	TCN	62.00	85.00	12.00	FPM
	TB4	55.00	72.00	9.00	NBR	TCN	62.00	85.00	12.00	NBR
	TCV	55.00	72.00	9.00	NBR	TCV	62.00	85.00	12.00	NBR
	BABSL	55.00	75.00	7.00	FPM	TB4	63.50	75.00	12.00	NBR
	BABSL	55.00	75.00	7.00	NBR	BABSL	65.00	80.00	7.00	NBR
	TCN	55.00	75.00	12.00	FPM	B2PT	65.00	80.00	10.00	PTFE
	TB4	55.00	75.00	12.50	NBR	TB4	65.00	81.00	10.00	NBR
<b>BABSL</b>  <b>50 PSI</b>	TB4	55.00	78.00	12.00	NBR	TCV	65.00	82.00	10.00	NBR
	TCN	55.00	78.00	12.00	FPM	B2PT	65.00	85.00	10.00	PTFE
	TCN	55.00	78.00	12.00	NBR	TCN	65.00	85.00	11.00	FPM
	TCV	55.00	78.00	12.00	FPM	TCN	65.00	85.00	11.00	NBR
	TCV	55.00	78.00	12.00	NBR	BAD	65.00	85.00	13.00	NBR
	B2PT	55.00	80.00	8.00	PTFE	TB4	65.00	88.00	12.00	NBR
	TB4	55.00	80.00	14.00	NBR	TCN	65.00	88.00	12.00	FPM
	TC4	56.00	72.00	9.00	NBR	TCN	65.00	88.00	12.00	NBR
<b>B2PT</b>  <b>145 PSI</b>	TC4	57.00	72.00	12.00	NBR	BABSL	65.00	90.00	7.00	NBR
	TC4	58.00	72.00	9.00	NBR	BABSL	65.00	90.00	7.00	FPM
	TCV	58.00	74.00	10.00	FPM	TCN	65.00	90.00	9.00	NBR
	TC4	58.00	80.00	12.00	NBR	TCN	65.00	90.00	10.00	FPM
	TCN	58.00	80.00	12.00	NBR	TCN	65.00	90.00	13.00	FPM
	TCV	58.00	80.00	12.00	NBR	TCN	65.00	90.00	13.00	NBR
	BABSL	60.00	72.00	7.00	NBR	TB4	65.00	90.00	14.00	NBR
	TB4	60.00	74.00	9.00	NBR	TCN	65.00	95.00	13.00	NBR
<b>BAD</b>  <b>22 PSI</b>	B2PT	60.00	75.00	8.00	PTFE	TB4	65.00	95.00	14.00	NBR
	BABSL	60.00	75.00	8.00	NBR	BABSL	68.00	90.00	10.00	NBR
	TCV	60.00	75.00	9.00	FPM	TCN	68.00	90.00	14.00	NBR
	BABSL	60.00	75.00	10.00	FPM	TB4	68.00	95.00	13.00	NBR
	TB4	60.00	78.00	9.00	NBR	TCN	68.00	95.00	13.00	FPM
	TCV	60.00	78.00	9.00	FPM	TCN	68.00	95.00	13.00	NBR
	TCV	60.00	78.00	9.00	NBR	TB4	70.00	86.00	10.00	NBR
	BABSL	60.00	80.00	7.00	NBR	TB4	70.00	88.00	12.00	NBR
<b>B1D</b>  <b>22 PSI</b>	TCV	60.00	75.00	9.00	FPM	TCN	68.00	90.00	14.00	NBR
	BABSL	60.00	75.00	10.00	FPM	TB4	68.00	95.00	13.00	NBR
	TB4	60.00	78.00	9.00	NBR	TCN	68.00	95.00	13.00	FPM
	TCV	60.00	78.00	9.00	FPM	TCN	68.00	95.00	13.00	NBR
	TCV	60.00	78.00	9.00	NBR	TB4	70.00	86.00	10.00	NBR
	TCV	60.00	78.00	9.00	NBR	TB4	70.00	88.00	12.00	NBR
	BABSL	60.00	80.00	7.00	NBR	TB4	70.00	88.00	12.00	NBR
	BABSL	60.00	80.00	7.00	NBR	TB4	70.00	88.00	12.00	NBR

N.B.: MINIMUM LINE ORDER MAY APPLY

Tel.: (604) 278-6808  
Fax: (604) 278-6180

**SS 263**

[www.sealsonline.com](http://www.sealsonline.com)









## NOK/SIMRIT AVAILABILITY LIST

## PRESSURE SEALS - NOK/SIMRIT

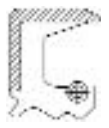
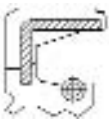
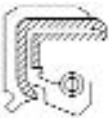
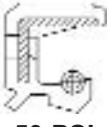
**METRIC SIZE  
SHAFT SEALS**

TB4  100 PSI	Design Type	Dimensions			Lip Material	Design Type	Dimensions			Lip Material
		d	D	H			d	D	H	
TC4  100 PSI	B2PT	100.00	130.00	12.00	PTFE	B1D	130.00	160.00	13.00	NBR
	B1D	100.00	130.00	13.00	NBR	TCN	130.00	160.00	14.00	FPM
	BABSL	105.00	130.00	7.50	NBR	TCN	130.00	160.00	14.00	NBR
	BABSL	105.00	130.00	7.50	FPM	TCN	135.00	165.00	14.00	FPM
	B2PT	105.00	130.00	12.00	PTFE	TCN	135.00	165.00	14.00	NBR
	B1D	105.00	130.00	13.00	NBR	BABSL	140.00	160.00	10.00	NBR
	TB4	105.00	135.00	14.00	NBR	BAD	140.00	165.00	12.00	NBR
	TCN	105.00	135.00	14.00	FPM	TB4	140.00	165.00	14.00	NBR
	TCN	105.00	135.00	14.00	NBR	TCN	140.00	170.00	14.00	FPM
	B2PT	110.00	130.00	12.00	PTFE	TCN	140.00	170.00	14.00	NBR
TCN  150 PSI	BABSL	110.00	130.00	12.00	NBR	BABSL	140.00	170.00	15.00	NBR
	TB4	110.00	135.00	14.00	NBR	BAD	140.00	170.00	15.00	NBR
	B2PT	110.00	140.00	12.00	PTFE	TB4	145.00	175.00	14.00	NBR
	BABSL	110.00	140.00	13.00	NBR	TCN	145.00	175.00	14.00	FPM
	BAD	110.00	140.00	13.00	NBR	BABSL	150.00	180.00	8.50	NBR
	TB4	110.00	140.00	14.00	NBR	TB4	150.00	180.00	14.00	NBR
	TCN	110.00	140.00	14.00	FPM	TC4	150.00	180.00	14.00	NBR
	TCN	110.00	140.00	14.00	NBR	TCN	150.00	180.00	14.00	FPM
	TCN	110.00	145.00	15.00	NBR	TCN	150.00	180.00	14.00	NBR
	BABSL	110.00	150.00	8.00	NBR	TCN	155.00	180.00	15.00	FPM
TCV  50 PSI	B2PT	115.00	140.00	12.00	PTFE	BABSL	160.00	185.00	8.50	NBR
	TCN	115.00	145.00	14.00	NBR	TB4	160.00	185.00	14.00	NBR
	BABSL	120.00	140.00	7.50	NBR	TC4	160.00	190.00	14.00	NBR
	BABSL	120.00	140.00	7.50	FPM	TCN	160.00	190.00	15.00	FPM
	BABSL	120.00	140.00	10.00	NBR	TCN	160.00	190.00	16.00	NBR
	B2PT	120.00	140.00	12.00	PTFE	TCN	165.00	195.00	15.00	NBR
	TB4	120.00	145.00	14.00	NBR	TB4	165.00	200.00	15.00	NBR
	BABSL	120.00	150.00	10.00	FPM	TB4	170.00	195.00	14.00	NBR
	BABSL	120.00	150.00	10.00	NBR	BABSL	170.00	200.00	14.00	FPM
	BABSL	120.00	150.00	12.00	NBR	BAD	170.00	200.00	15.00	NBR
B2PT  145 PSI	BAD	120.00	150.00	13.00	NBR	TCN	170.00	200.00	16.00	FPM
	TB4	120.00	150.00	14.00	NBR	TCN	170.00	200.00	16.00	NBR
	TC4	120.00	150.00	14.00	NBR	TB4	180.00	205.00	14.00	NBR
	TCN	120.00	150.00	14.00	FPM	BABSL	180.00	210.00	8.50	NBR
	TCN	120.00	150.00	14.00	NBR	TB4	180.00	210.00	14.00	NBR
	B1D	120.00	150.00	15.00	NBR	TCN	180.00	210.00	16.00	FPM
	B2PT	125.00	150.00	12.00	PTFE	TCN	180.00	210.00	16.00	NBR
	B1D	125.00	150.00	13.00	NBR	TC4	180.00	215.00	18.00	NBR
	BAD	125.00	150.00	13.00	NBR	TB4	190.00	215.00	14.00	NBR
	TB4	125.00	150.00	14.00	NBR	TCN	190.00	225.00	16.00	FPM
BAD  22 PSI	TCN	125.00	150.00	15.00	NBR	TCN	190.00	225.00	16.00	NBR
	TC4	125.00	155.00	14.00	NBR	TB4	200.00	225.00	14.00	NBR
	TCN	125.00	155.00	14.00	FPM	BABSL	200.00	230.00	13.00	NBR
	TCN	125.00	155.00	14.00	NBR	BAD	200.00	230.00	15.00	NBR
	TB4	125.00	160.00	18.00	NBR	TCN	200.00	230.00	17.00	NBR
	BABSL	130.00	150.00	7.50	NBR	TB4	200.00	240.00	20.00	NBR
	TB4	130.00	155.00	14.00	NBR	TCN	200.00	240.00	20.00	FPM
	BABSL	130.00	160.00	12.00	NBR	TC4	200.00	255.00	25.00	NBR

N.B.: MINIMUM LINE ORDER MAY APPLY

Tel.: (418) 688-3202  
Fax: (418) 688-4272

**SS 265**

[www.sealsonline.com](http://www.sealsonline.com)





## V-RINGS

The V-ring is an axial face seal made of pure elastomer without reinforced fabric or metal. The V-ring is suitable for use as a single seal against dirt, dust, water, grease or oil. The sealing lip slides on a mating surface at right-angles to the shaft. The ring rotates with the shaft. The five different profile types A, E, L, S, and RM are available for the many possible applications. The E and RM types are designed mainly for use in heavy machinery. The RM V-ring has a groove on the outer periphery for accepting a clamping strip.

The sealing lip runs on a mating surface positioned vertically with respect to the shaft. The ring runs together with the shaft.

The V-ring provides a reliable seal when the shaft is both tilted and eccentric to its axis.

Standard materials are nitrile rubber (NBR) resistant to mineral oil-based media and fluorinated rubber for high temperatures and aggressive media. V-rings can also be made of other materials on request.

Application limits		
Pressure	0.3 bar	4.35 PSI
Temperature		
NBR	-40...+100°C	-40...+212°F
FPM	-23...+150°C	-9.4...+302°F

Surface finish		
Surface roughness	$R_a$	$R_t$
Sliding surface	$\geq 2.5 \mu\text{m}$	$\geq 12 \mu\text{m}$

No special machining is required since the V-ring adheres firmly to the shaft.

### TYPE A



The most common style available in the widest range of sizes from 2.7mm shaft to 2020mm nitrile and fluoroelastomer. Ideal for conveyor rollers and appliances.

### TYPE L



Very narrow axial cross-section commonly used in pillow blocks to enhance or replace labyrinth seals. Available in nitrile and fluoroelastomer for shaft sizes from 105mm shaft to 630mm, also available up to 2025mm.

### TYPE S

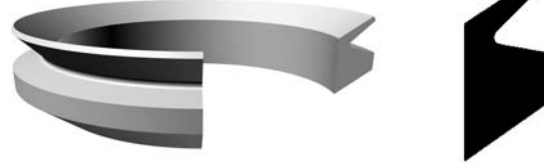

The original V-ring designed with a wide body and tapered heel to firmly hold the ring on the shaft. Available in sizes from 4.5mm shaft to 210mm. Commonly use in agricultural and automotive applications.

### TYPE E



The heavy duty large-diameter style commonly used in rolling mills as a dirt/water excluder seal. Available in both nitrile and fluoroelastomer for shaft sizes from 300mm to 2010mm.

### TYPE RM



A heavy duty large-diameter style designed to operate in severe running conditions. The unique body can accommodate radial and axial support in high shaft speed applications. This V-ring can be trimmed to meet existing space requirements, (with a minimum fitted width of 42.5mm). Available in sizes from 300mm shaft to 3000mm in nitrile only. The RM is a made-to-order item.

## V-RINGS - TYPE A

### Type A

Profile and installation dimensions

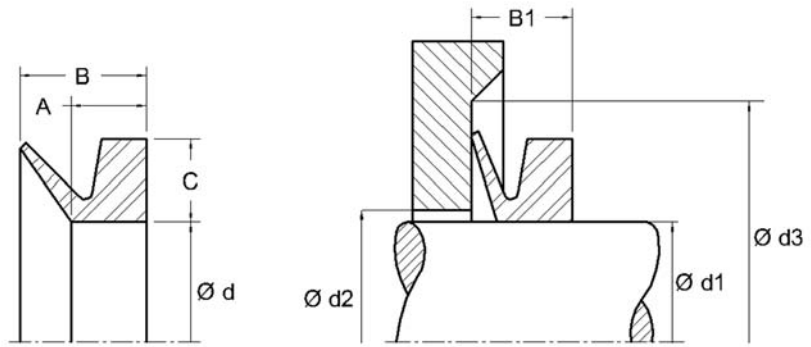

Ref. Number	For shaft diameter		Ød	Section height c	Section width			Diameter		CR Reference (NBR)
	d1 min.	d1 max.			A	B (before installation)	B1 (after installation)	max. d2	min. d3	
V-0003A	2.70 - 3.50		2.50	1.50	2.10	3.00	2.50 +/- 0.30	d1 + 1.00	d1 + 4.00	400030
V-0004A	3.50 - 4.50		3.20	2.00	2.40	3.70	3.00 +/- 0.40	d1 + 1.00	d1 + 6.00	400040
V-0005A	4.50 - 5.50		4.00	2.00	2.40	3.70	3.00 +/- 0.40	d1 + 1.00	d1 + 6.00	400050
V-0006A	5.50 - 6.50		5.00	2.00	2.40	3.70	3.00 +/- 0.40	d1 + 1.00	d1 + 6.00	400060
V-0007A	6.50 - 8.00		6.00	2.00	2.40	3.70	3.00 +/- 0.40	d1 + 1.00	d1 + 6.00	400070
V-0008A	8.00 - 9.50		7.00	2.00	2.40	3.70	3.00 +/- 0.40	d1 + 1.00	d1 + 6.00	400080
V-0010A	9.50 - 11.50		9.00	3.00	3.40	5.50	4.50 +/- 0.60	d1 + 1.00	d1 + 9.00	400100
V-0012A	11.50 - 12.50		10.50	3.00	3.40	5.50	4.50 +/- 0.60	d1 + 1.00	d1 + 9.00	400120
V-0013A	12.50 - 13.50		11.70	3.00	3.40	5.50	4.50 +/- 0.60	d1 + 1.00	d1 + 9.00	400130
V-0014A	13.50 - 15.50		12.50	3.00	3.40	5.50	4.50 +/- 0.60	d1 + 1.00	d1 + 9.00	400140
V-0016A	15.50 - 17.00		14.00	3.00	3.40	5.50	4.50 +/- 0.60	d1 + 1.00	d1 + 9.00	400160
V-0018A	17.50 - 19.00		16.00	3.00	3.40	5.50	4.50 +/- 0.60	d1 + 1.00	d1 + 9.00	400180
V-0020A	19.00 - 21.00		18.00	4.00	4.70	7.50	6.00 +/- 0.80	d1 + 2.00	d1 + 12.00	400200
V-0022A	21.00 - 24.00		20.00	4.00	4.70	7.50	6.00 +/- 0.80	d1 + 2.00	d1 + 12.00	400220
V-0025A	24.00 - 27.00		22.00	4.00	4.70	7.50	6.00 +/- 0.80	d1 + 2.00	d1 + 12.00	400250
V-0028A	27.00 - 29.00		25.00	4.00	4.70	7.50	6.00 +/- 0.80	d1 + 2.00	d1 + 12.00	400280
V-0030A	29.00 - 31.00		27.00	4.00	4.70	7.50	6.00 +/- 0.80	d1 + 2.00	d1 + 12.00	400300
V-0032A	31.00 - 33.00		29.00	4.00	4.70	7.50	6.00 +/- 0.80	d1 + 2.00	d1 + 12.00	400320
V-0035A	33.00 - 36.00		31.00	4.00	4.70	7.50	6.00 +/- 0.80	d1 + 2.00	d1 + 12.00	400350
V-0038A	36.00 - 38.00		34.00	4.00	4.70	7.50	6.00 +/- 0.80	d1 + 2.00	d1 + 12.00	400380
V-0040A	38.00 - 43.00		36.00	5.00	5.50	9.00	7.00 +/- 1.00	d1 + 2.00	d1 + 15.00	400400
V-0045A	43.00 - 48.00		40.00	5.00	5.50	9.00	7.00 +/- 1.00	d1 + 2.00	d1 + 15.00	400450
V-0050A	48.00 - 53.00		45.00	5.00	5.50	9.00	7.00 +/- 1.00	d1 + 2.00	d1 + 15.00	400500
V-0055A	53.00 - 58.00		49.00	5.00	5.50	9.00	7.00 +/- 1.00	d1 + 2.00	d1 + 15.00	400550
V-0060A	58.00 - 63.00		54.00	5.00	5.50	9.00	7.00 +/- 1.00	d1 + 2.00	d1 + 15.00	400600
V-0065A	63.00 - 68.00		58.00	5.00	5.50	9.00	7.00 +/- 1.00	d1 + 2.00	d1 + 15.00	400650
V-0070A	68.00 - 73.00		63.00	6.00	6.80	11.00	9.00 +/- 1.20	d1 + 3.00	d1 + 18.00	400700
V-0075A	73.00 - 78.00		67.00	6.00	6.80	11.00	9.00 +/- 1.20	d1 + 3.00	d1 + 18.00	400750
V-0080A	78.00 - 83.00		72.00	6.00	6.80	11.00	9.00 +/- 1.20	d1 + 3.00	d1 + 18.00	400800
V-0085A	83.00 - 88.00		76.00	6.00	6.80	11.00	9.00 +/- 1.20	d1 + 3.00	d1 + 18.00	400850
V-0090A	88.00 - 93.00		81.00	6.00	6.80	11.00	9.00 +/- 1.20	d1 + 3.00	d1 + 18.00	400900
V-0095A	93.00 - 98.00		85.00	6.00	6.80	11.00	9.00 +/- 1.20	d1 + 3.00	d1 + 18.00	400950
V-0100A	98.00 - 105.00		90.00	6.00	6.80	11.00	9.00 +/- 1.20	d1 + 3.00	d1 + 18.00	401000
V-0110A	105.00 - 115.00		99.00	7.00	7.90	12.80	10.50 +/- 1.50	d1 + 4.00	d1 + 21.00	401100
V-0120A	115.00 - 125.00		108.00	7.00	7.90	12.80	10.50 +/- 1.50	d1 + 4.00	d1 + 21.00	401200

N.B.: MINIMUM LINE ORDER MAY APPLY

METRIC SIZE V-RINGS

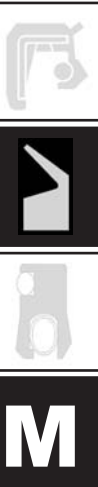

## V-RINGS - TYPE A

METRIC SIZE  
V-RINGS

Ref. Number	For shaft diameter		Ød	Section height c	Section width			Diameter		CR Reference (NBR)
	d1				A	B (before installation)	B1 (after installation)	max. d2	min. d3	
	min.	max.								
V-0130A	125.00	135.00	117.00	7.00	7.90	12.80	10.50 +/- 1.50	d1 + 4.00	d1 + 21.00	401300
V-0140A	135.00	145.00	126.00	7.00	7.90	12.80	10.50 +/- 1.50	d1 + 4.00	d1 + 21.00	401400
V-0150A	145.00	155.00	135.00	7.00	7.90	12.80	10.50 +/- 1.50	d1 + 4.00	d1 + 21.00	401500
V-0160A	155.00	165.00	144.00	8.00	9.00	14.50	12.00 +/- 1.80	d1 + 4.00	d1 + 24.00	401600
V-0170A	165.00	175.00	153.00	8.00	9.00	14.50	12.00 +/- 1.80	d1 + 4.00	d1 + 24.00	401700
V-0180A	175.00	185.00	162.00	8.00	9.00	14.50	12.00 +/- 1.80	d1 + 4.00	d1 + 24.00	401800
V-0190A	185.00	195.00	171.00	8.00	9.00	14.50	12.00 +/- 1.80	d1 + 4.00	d1 + 24.00	401900
V-0199A	195.00	210.00	180.00	8.00	9.00	14.50	12.00 +/- 1.80	d1 + 4.00	d1 + 24.00	401990
V-0200A	190.00	210.00	180.00	15.00	14.30	25.00	20.00 +/- 4.00	d1 + 10.00	d1 + 45.00	402000
V-0220A	210.00	235.00	198.00	15.00	14.30	25.00	20.00 +/- 4.00	d1 + 10.00	d1 + 45.00	402200
V-0250A	235.00	265.00	225.00	15.00	14.30	25.00	20.00 +/- 4.00	d1 + 10.00	d1 + 45.00	402500
V-0275A	265.00	290.00	247.00	15.00	14.30	25.00	20.00 +/- 4.00	d1 + 10.00	d1 + 45.00	402750
V-0300A	290.00	310.00	270.00	15.00	14.30	25.00	20.00 +/- 4.00	d1 + 10.00	d1 + 45.00	403000
V-0325A	310.00	335.00	292.00	15.00	14.30	25.00	20.00 +/- 4.00	d1 + 10.00	d1 + 45.00	403250
V-0350A	335.00	365.00	315.00	15.00	14.30	25.00	20.00 +/- 4.00	d1 + 10.00	d1 + 45.00	403500
V-0375A	365.00	390.00	337.00	15.00	14.30	25.00	20.00 +/- 4.00	d1 + 10.00	d1 + 45.00	403750
V-0400A	390.00	430.00	360.00	15.00	14.30	25.00	20.00 +/- 4.00	d1 + 10.00	d1 + 45.00	404000
V-0450A	430.00	480.00	405.00	15.00	14.30	25.00	20.00 +/- 4.00	d1 + 10.00	d1 + 45.00	404500
V-0500A	480.00	530.00	450.00	15.00	14.30	25.00	20.00 +/- 4.00	d1 + 10.00	d1 + 45.00	405000
V-0550A	530.00	580.00	495.00	15.00	14.30	25.00	20.00 +/- 4.00	d1 + 10.00	d1 + 45.00	405500
V-0600A	580.00	630.00	540.00	15.00	14.30	25.00	20.00 +/- 4.00	d1 + 10.00	d1 + 45.00	406000
V-0650A	630.00	665.00	600.00	15.00	14.30	25.00	20.00 +/- 4.00	d1 + 10.00	d1 + 45.00	406500
V-0700A	665.00	705.00	630.00	15.00	14.30	25.00	20.00 +/- 4.00	d1 + 10.00	d1 + 45.00	407000
V-0725A	705.00	745.00	670.00	15.00	14.30	25.00	20.00 +/- 4.00	d1 + 10.00	d1 + 45.00	407250
V-0750A	745.00	785.00	705.00	15.00	14.30	25.00	20.00 +/- 4.00	d1 + 10.00	d1 + 45.00	407500
V-0800A	785.00	830.00	745.00	15.00	14.30	25.00	20.00 +/- 4.00	d1 + 10.00	d1 + 45.00	408000
V-0850A	830.00	875.00	785.00	15.00	14.30	25.00	20.00 +/- 4.00	d1 + 10.00	d1 + 45.00	408500
V-0900A	875.00	920.00	825.00	15.00	14.30	25.00	20.00 +/- 4.00	d1 + 10.00	d1 + 45.00	409000
V-0950A	920.00	965.00	865.00	15.00	14.30	25.00	20.00 +/- 4.00	d1 + 10.00	d1 + 45.00	409500
V-1000A	965.00	1015.00	910.00	15.00	14.30	25.00	20.00 +/- 4.00	d1 + 10.00	d1 + 45.00	410000
V-1050A	1015.00	1065.00	955.00	15.00	14.30	25.00	20.00 +/- 4.00	d1 + 10.00	d1 + 45.00	410500
V-1100A	1065.00	1115.00	1000.00	15.00	14.30	25.00	20.00 +/- 4.00	d1 + 10.00	d1 + 45.00	411000
V-1150A	1115.00	1165.00	1045.00	15.00	14.30	25.00	20.00 +/- 4.00	d1 + 10.00	d1 + 45.00	411500
V-1200A	1165.00	1215.00	1090.00	15.00	14.30	25.00	20.00 +/- 4.00	d1 + 10.00	d1 + 45.00	412000
V-1250A	1215.00	1270.00	1135.00	15.00	14.30	25.00	20.00 +/- 4.00	d1 + 10.00	d1 + 45.00	412500
V-1300A	1270.00	1320.00	1180.00	15.00	14.30	25.00	20.00 +/- 4.00	d1 + 10.00	d1 + 45.00	413000
V-1350A	1320.00	1370.00	1225.00	15.00	14.30	25.00	20.00 +/- 4.00	d1 + 10.00	d1 + 45.00	413500
V-1400A	1370.00	1420.00	1270.00	15.00	14.30	25.00	20.00 +/- 4.00	d1 + 10.00	d1 + 45.00	414000
V-1450A	1420.00	1470.00	1315.00	15.00	14.30	25.00	20.00 +/- 4.00	d1 + 10.00	d1 + 45.00	414500
V-1500A	1470.00	1520.00	1360.00	15.00	14.30	25.00	20.00 +/- 4.00	d1 + 10.00	d1 + 45.00	415000
V-1550A	1520.00	1570.00	1405.00	15.00	14.30	25.00	20.00 +/- 4.00	d1 + 10.00	d1 + 45.00	415500
V-1600A	1570.00	1620.00	1450.00	15.00	14.30	25.00	20.00 +/- 4.00	d1 + 10.00	d1 + 45.00	416000
V-1650A	1620.00	1670.00	1495.00	15.00	14.30	25.00	20.00 +/- 4.00	d1 + 10.00	d1 + 45.00	416500
V-1700A	1670.00	1720.00	1540.00	15.00	14.30	25.00	20.00 +/- 4.00	d1 + 10.00	d1 + 45.00	417000
V-1750A	1720.00	1770.00	1585.00	15.00	14.30	25.00	20.00 +/- 4.00	d1 + 10.00	d1 + 45.00	417500
V-1800A	1770.00	1820.00	1630.00	15.00	14.30	25.00	20.00 +/- 4.00	d1 + 10.00	d1 + 45.00	418000

N.B.: MINIMUM LINE ORDER MAY APPLY

**Tel.: (888) 238-5885**  
**Fax: (888) 238-1664**

**SS 269**

[www.sealsonline.com](http://www.sealsonline.com)

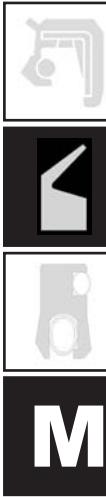

## V-RINGS - TYPE A

Ref. Number	For shaft diameter		Ød	Section height c	Section width			Diameter		CR Reference (NBR)
	min. d1	max. d1			A	B (before installation)	B1 (after installation)	max. d2	min. d3	
V-1850A	1820.00 - 1870.00		1675.00	15.00	14.30	25.00	20.00 +/- 4.00	d1 + 10.00	d1 + 45.00	418500
V-1900A	1870.00 - 1920.00		1720.00	15.00	14.30	25.00	20.00 +/- 4.00	d1 + 10.00	d1 + 45.00	419000
V-1950A	1920.00 - 1970.00		1765.00	15.00	14.30	25.00	20.00 +/- 4.00	d1 + 10.00	d1 + 45.00	419500
V-2000A	1970.00 - 2020.00		1810.00	15.00	14.30	25.00	20.00 +/- 4.00	d1 + 10.00	d1 + 45.00	419990
V-2100A	2020.00 - 2070.00		1855.00	15.00	14.30	25.00	20.00 +/- 4.00	d1 + 10.00	d1 + 45.00	421000
V-2500A	2070.00 - 2120.00		1900.00	15.00	14.30	25.00	20.00 +/- 4.00	d1 + 10.00	d1 + 45.00	425000

## V-RINGS - TYPE L

### Type L

**Profile and installation dimension**

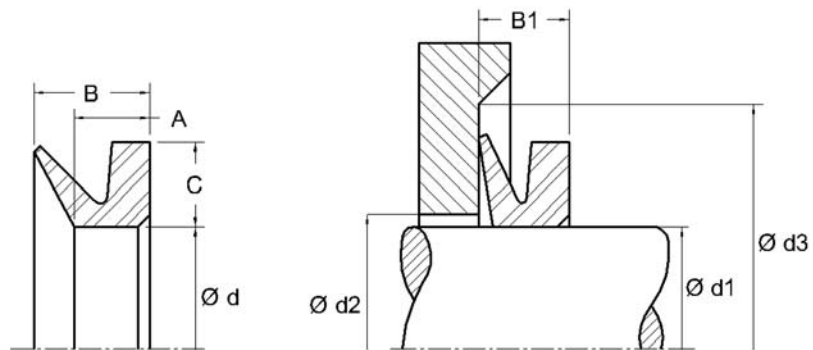

Ref. Number	For shaft diameter		Ød	Section height c	Section width			Diameter		CR Reference (NBR)
	min. d1	max. d1			A	B (before installation)	B1 (after installation)	max. d2	min. d3	
V-0110L	105.00	115.00	99.00	6.50	6.00	10.50	8.00 +/- 1.50	d1 + 5.00	20.00	
V-0120L	115.00	125.00	108.00	6.50	6.00	10.50	8.00 +/- 1.50	d1 + 5.00	20.00	
V-0130L	125.00	135.00	117.00	6.50	6.00	10.50	8.00 +/- 1.50	d1 + 5.00	20.00	
V-0140L	135.00	145.00	126.00	6.50	6.00	10.50	8.00 +/- 1.50	d1 + 5.00	20.00	401402
V-0150L	145.00	155.00	135.00	6.50	6.00	10.50	8.00 +/- 1.50	d1 + 5.00	20.00	401502
V-0160L	155.00	165.00	144.00	6.50	6.00	10.50	8.00 +/- 1.50	d1 + 5.00	20.00	401602
V-0170L	165.00	175.00	153.00	6.50	6.00	10.50	8.00 +/- 1.50	d1 + 5.00	20.00	401702
V-0180L	175.00	185.00	162.00	6.50	6.00	10.50	8.00 +/- 1.50	d1 + 5.00	20.00	401802
V-0190L	185.00	195.00	171.00	6.50	6.00	10.50	8.00 +/- 1.50	d1 + 5.00	20.00	401902
V-0200L	195.00	210.00	182.00	6.50	6.00	10.50	8.00 +/- 1.50	d1 + 5.00	20.00	402002
V-0220L	210.00	233.00	198.00	6.50	6.00	10.50	8.00 +/- 1.50	d1 + 5.00	20.00	402202
V-0250L	233.00	260.00	225.00	6.50	6.00	10.50	8.00 +/- 1.50	d1 + 5.00	20.00	402502
V-0275L	260.00	285.00	247.00	6.50	6.00	10.50	8.00 +/- 1.50	d1 + 5.00	20.00	402752
V-0300L	285.00	310.00	270.00	6.50	6.00	10.50	8.00 +/- 1.50	d1 + 5.00	20.00	403002
V-0325L	310.00	335.00	292.00	6.50	6.00	10.50	8.00 +/- 1.50	d1 + 5.00	20.00	403252
V-0350L	335.00	365.00	315.00	6.50	6.00	10.50	8.00 +/- 1.50	d1 + 5.00	20.00	403502
V-0375L	365.00	385.00	337.00	6.50	6.00	10.50	8.00 +/- 1.50	d1 + 5.00	20.00	403752
V-0400L	385.00	410.00	360.00	6.50	6.00	10.50	8.00 +/- 1.50	d1 + 5.00	20.00	404002
V-0425L	410.00	440.00	382.00	6.50	6.00	10.50	8.00 +/- 1.50	d1 + 5.00	20.00	404252
V-0450L	440.00	475.00	405.00	6.50	6.00	10.50	8.00 +/- 1.50	d1 + 5.00	20.00	404502
V-0500L	475.00	510.00	450.00	6.50	6.00	10.50	8.00 +/- 1.50	d1 + 5.00	20.00	405002

N.B.: MINIMUM LINE ORDER MAY APPLY

## V-RINGS - TYPE L

METRIC SIZE  
V-RINGS

Ref. Number	For shaft diameter		Ød	Section height c	Section width			Diameter		CR Reference (NBR)
	d1				A	B (before installation)	B1 (after installation)	max. d2	min. d3	
	min.	max.								
V-0525L	510.00	540.00	472.00	6.50	6.00	10.50	8.00 +/- 1.50	d1 + 5.00	20.00	405252
V-0550L	540.00	575.00	495.00	6.50	6.00	10.50	8.00 +/- 1.50	d1 + 5.00	20.00	405502
V-0600L	575.00	625.00	540.00	6.50	6.00	10.50	8.00 +/- 1.50	d1 + 5.00	20.00	406002
V-0650L	625.00	675.00	600.00	6.50	6.00	10.50	8.00 +/- 1.50	d1 + 5.00	20.00	
V-0700L	675.00	710.00	630.00	6.50	6.00	10.50	8.00 +/- 1.50	d1 + 5.00	20.00	
V-0725L	710.00	740.00	670.00	6.50	6.00	10.50	8.00 +/- 1.50	d1 + 5.00	20.00	
V-0750L	740.00	775.00	705.00	6.50	6.00	10.50	8.00 +/- 1.50	d1 + 5.00	20.00	407502
V-0800L	775.00	825.00	745.00	6.50	6.00	10.50	8.00 +/- 1.50	d1 + 5.00	20.00	
V-0850L	825.00	875.00	785.00	6.50	6.00	10.50	8.00 +/- 1.50	d1 + 5.00	20.00	
V-0900L	875.00	925.00	825.00	6.50	6.00	10.50	8.00 +/- 1.50	d1 + 5.00	20.00	409002
V-0950L	925.00	975.00	865.00	6.50	6.00	10.50	8.00 +/- 1.50	d1 + 5.00	20.00	
V-1000L	975.00	1025.00	910.00	6.50	6.00	10.50	8.00 +/- 1.50	d1 + 5.00	20.00	
V-1050L	1025.00	1075.00	955.00	6.50	6.00	10.50	8.00 +/- 1.50	d1 + 5.00	20.00	
V-1100L	1075.00	1125.00	1000.00	6.50	6.00	10.50	8.00 +/- 1.50	d1 + 5.00	20.00	
V-1150L	1125.00	1175.00	1045.00	6.50	6.00	10.50	8.00 +/- 1.50	d1 + 5.00	20.00	411502
V-1200L	1175.00	1225.00	1090.00	6.50	6.00	10.50	8.00 +/- 1.50	d1 + 5.00	20.00	412002
V-1250L	1225.00	1275.00	1135.00	6.50	6.00	10.50	8.00 +/- 1.50	d1 + 5.00	20.00	
V-1300L	1275.00	1325.00	1180.00	6.50	6.00	10.50	8.00 +/- 1.50	d1 + 5.00	20.00	
V-1350L	1325.00	1375.00	1225.00	6.50	6.00	10.50	8.00 +/- 1.50	d1 + 5.00	20.00	413502
V-1400L	1375.00	1425.00	1270.00	6.50	6.00	10.50	8.00 +/- 1.50	d1 + 5.00	20.00	
V-1450L	1425.00	1475.00	1315.00	6.50	6.00	10.50	8.00 +/- 1.50	d1 + 5.00	20.00	
V-1500L	1475.00	1525.00	1360.00	6.50	6.00	10.50	8.00 +/- 1.50	d1 + 5.00	20.00	
V-1550L	1525.00	1575.00	1405.00	6.50	6.00	10.50	8.00 +/- 1.50	d1 + 5.00	20.00	
V-1600L	1575.00	1625.00	1450.00	6.50	6.00	10.50	8.00 +/- 1.50	d1 + 5.00	20.00	
V-1650L	1625.00	1675.00	1495.00	6.50	6.00	10.50	8.00 +/- 1.50	d1 + 5.00	20.00	
V-1700L	1675.00	1725.00	1540.00	6.50	6.00	10.50	8.00 +/- 1.50	d1 + 5.00	20.00	
V-1750L	1725.00	1775.00	1585.00	6.50	6.00	10.50	8.00 +/- 1.50	d1 + 5.00	20.00	
V-1800L	1775.00	1825.00	1630.00	6.50	6.00	10.50	8.00 +/- 1.50	d1 + 5.00	20.00	
V-1850L	1825.00	1875.00	1675.00	6.50	6.00	10.50	8.00 +/- 1.50	d1 + 5.00	20.00	
V-1900L	1875.00	1925.00	1720.00	6.50	6.00	10.50	8.00 +/- 1.50	d1 + 5.00	20.00	
V-1950L	1925.00	1975.00	1765.00	6.50	6.00	10.50	8.00 +/- 1.50	d1 + 5.00	20.00	
V-2000L	1975.00	2025.00	1810.00	6.50	6.00	10.50	8.00 +/- 1.50	d1 + 5.00	20.00	

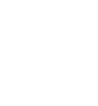

N.B.: MINIMUM LINE ORDER MAY APPLY

**Tel.: (204) 783-9617**  
**Fax: (204) 783-6091**

**SS 271**

[www.sealsonline.com](http://www.sealsonline.com)



## V-RINGS - TYPE S

### Type S

Profile and installation dimensions

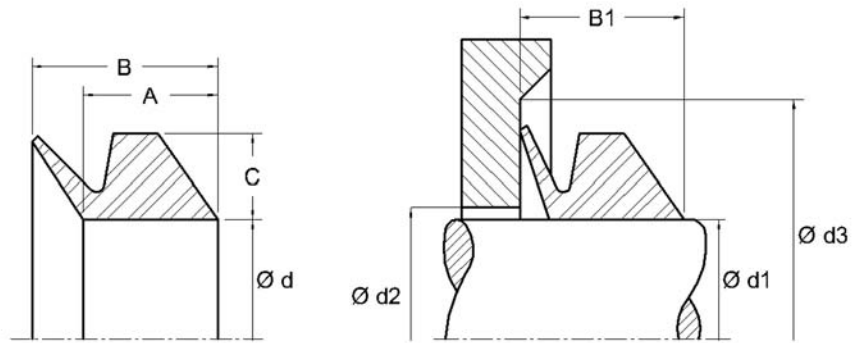

Ref. Number	For shaft diameter		Ød	Section height c	Section width			Diameter		CR Reference (NBR)
	d1 min.	d1 max.			A	B (before installation)	B1 (after installation)	max. d2	min. d3	
V-0005S	4.50 - 5.50		4.00	2.00	3.90	5.20	4.50 +/- 0.40	d1 + 1.00	6.00	400051
V-0006S	5.50 - 6.50		5.00	2.00	3.90	5.20	4.50 +/- 0.40	d1 + 1.00	6.00	400061
V-0007S	6.50 - 8.00		6.00	2.00	3.90	5.20	4.50 +/- 0.40	d1 + 1.00	6.00	400071
V-0008S	8.00 - 9.50		7.00	2.00	3.90	5.20	4.50 +/- 0.40	d1 + 1.00	6.00	400081
V-0010S	9.50 - 11.50		9.00	3.00	5.60	7.70	6.70 +/- 0.60	d1 + 1.00	9.00	400101
V-0012S	11.50 - 13.50		10.50	3.00	5.60	7.70	6.70 +/- 0.60	d1 + 1.00	9.00	400121
V-0014S	13.50 - 15.50		12.50	3.00	5.60	7.70	6.70 +/- 0.60	d1 + 1.00	9.00	400141
V-0016S	15.50 - 17.00		14.00	3.00	5.60	7.70	6.70 +/- 0.60	d1 + 1.00	9.00	400161
V-0018S	17.50 - 19.00		16.00	3.00	5.60	7.70	6.70 +/- 0.60	d1 + 1.00	9.00	400181
V-0020S	19.00 - 21.00		18.00	4.00	7.90	10.50	9.00 +/- 0.80	d1 + 2.00	12.00	400201
V-0022S	21.00 - 24.00		20.00	4.00	7.90	10.50	9.00 +/- 0.80	d1 + 2.00	12.00	400221
V-0025S	24.00 - 27.00		22.00	4.00	7.90	10.50	9.00 +/- 0.80	d1 + 2.00	12.00	400251
V-0028S	27.00 - 29.00		25.00	4.00	7.90	10.50	9.00 +/- 0.80	d1 + 2.00	12.00	400281
V-0030S	29.00 - 31.00		27.00	4.00	7.90	10.50	9.00 +/- 0.80	d1 + 2.00	12.00	400301
V-0032S	31.00 - 33.00		29.00	4.00	7.90	10.50	9.00 +/- 0.80	d1 + 2.00	12.00	400321
V-0035S	33.00 - 36.00		31.00	4.00	7.90	10.50	9.00 +/- 0.80	d1 + 2.00	12.00	400351
V-0038S	36.00 - 38.00		34.00	4.00	7.90	10.50	9.00 +/- 0.80	d1 + 2.00	12.00	400381
V-0040S	38.00 - 43.00		36.00	5.00	9.50	13.00	11.00 +/- 1.00	d1 + 2.00	15.00	400401
V-0045S	43.00 - 48.00		40.00	5.00	9.50	13.00	11.00 +/- 1.00	d1 + 2.00	15.00	400451
V-0050S	48.00 - 53.00		45.00	5.00	9.50	13.00	11.00 +/- 1.00	d1 + 2.00	15.00	400501
V-0055S	53.00 - 58.00		49.00	5.00	9.50	13.00	11.00 +/- 1.00	d1 + 2.00	15.00	400551
V-0060S	58.00 - 63.00		54.00	5.00	9.50	13.00	11.00 +/- 1.00	d1 + 2.00	15.00	400601
V-0065S	63.00 - 68.00		58.00	5.00	9.50	13.00	11.00 +/- 1.00	d1 + 2.00	15.00	400651
V-0070S	68.00 - 73.00		63.00	6.00	11.30	15.50	13.50 +/- 1.20	d1 + 3.00	18.00	400701
V-0075S	73.00 - 78.00		67.00	6.00	11.30	15.50	13.50 +/- 1.20	d1 + 3.00	18.00	400751
V-0080S	78.00 - 83.00		72.00	6.00	11.30	15.50	13.50 +/- 1.20	d1 + 3.00	18.00	400801
V-0085S	83.00 - 88.00		76.00	6.00	11.30	15.50	13.50 +/- 1.20	d1 + 3.00	18.00	400851
V-0090S	88.00 - 93.00		81.00	6.00	11.30	15.50	13.50 +/- 1.20	d1 + 3.00	18.00	400901
V-0095S	93.00 - 98.00		85.00	6.00	11.30	15.50	13.50 +/- 1.20	d1 + 3.00	18.00	400951
V-0100S	98.00 - 105.00		90.00	6.00	11.30	15.50	13.50 +/- 1.20	d1 + 3.00	18.00	401001
V-0110S	105.00 - 115.00		99.00	7.00	13.10	18.00	15.50 +/- 1.50	d1 + 4.00	21.00	401101
V-0120S	115.00 - 125.00		108.00	7.00	13.10	18.00	15.50 +/- 1.50	d1 + 4.00	21.00	401201
V-0130S	125.00 - 135.00		117.00	7.00	13.10	18.00	15.50 +/- 1.50	d1 + 4.00	21.00	401301
V-0140S	135.00 - 145.00		126.00	7.00	13.10	18.00	15.50 +/- 1.50	d1 + 4.00	21.00	401401
V-0150S	145.00 - 155.00		135.00	7.00	13.10	18.00	15.50 +/- 1.50	d1 + 4.00	21.00	401501

N.B.: MINIMUM LINE ORDER MAY APPLY

METRIC SIZE V-RINGS

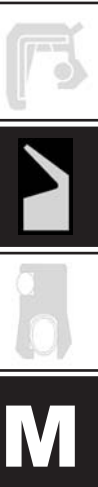

## V-RINGS - TYPE S

METRIC SIZE  
V-RINGS

Ref. Number	For shaft diameter		Ød	Section height c	Section width			Diameter		CR Reference (NBR)
	d1 min.	d1 max.			A	B (before installation)	B1 (after installation)	max. d2	min. d3	
V-0160S	155.00	165.00	144.00	8.00	15.00	20.50	18.00 +/- 1.80	d1 + 4.00	24.00	401601
V-0170S	165.00	175.00	153.00	8.00	15.00	20.50	18.00 +/- 1.80	d1 + 4.00	24.00	401701
V-0180S	175.00	185.00	162.00	8.00	15.00	20.50	18.00 +/- 1.80	d1 + 4.00	24.00	401801
V-0190S	185.00	195.00	171.00	8.00	15.00	20.50	18.00 +/- 1.80	d1 + 4.00	24.00	401901
V-0199S	195.00	210.00	180.00	8.00	15.00	20.50	18.00 +/- 1.80	d1 + 4.00	24.00	401991



V-RING - TYPE S

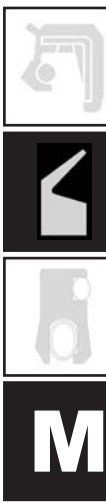

N.B.: MINIMUM LINE ORDER MAY APPLY

**Tel.: (780) 414-1871**  
**Fax: (780) 487-5419**

**SS 273**

[www.sealonline.com](http://www.sealonline.com)

## AXIAL SHAFT SEALS - VRM01

### VRM01

#### Profile and installation dimensions

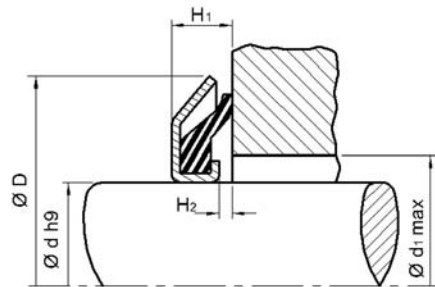
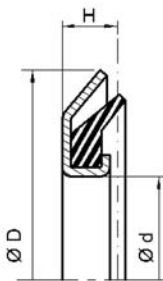

Ref.Number	Nominal Seal Dimensions			Housing Dimensions			Ref.Number	Nominal Seal Dimensions			Housing Dimensions		
	d	D	H	H1	H2	d1		d	D	H	H1	H2	d1
VRM01-10	10.00	24.00	3.50	3.50	1.00	15.00	VRM01-45	45.00	62.00	4.50	4.50	1.00	52.00
VRM01-11	11.00	26.00	3.50	3.50	1.00	17.00	VRM01-48	48.00	65.00	4.50	4.50	1.00	55.00
VRM01-12	12.00	26.00	3.50	3.50	1.00	17.00	VRM01-50	50.00	70.00	5.50	5.50	1.00	58.00
VRM01-14	14.00	30.00	4.00	4.00	1.00	21.00	VRM01-52	52.00	72.00	5.50	5.50	1.00	60.00
VRM01-15	15.00	30.00	4.00	4.00	1.00	21.00	VRM01-55	55.00	75.00	5.50	5.50	1.00	63.00
VRM01-16	16.00	32.00	4.00	4.00	1.00	23.00	VRM01-58	58.00	78.00	5.50	5.50	1.00	66.00
VRM01-17	17.00	32.00	4.00	4.00	1.00	23.00	VRM01-60	60.00	80.00	5.50	5.50	1.00	68.00
VRM01-18	18.00	33.00	4.00	4.00	1.00	24.00	VRM01-62	62.00	82.00	5.50	5.50	1.00	70.00
VRM01-20	20.00	35.00	4.00	4.00	1.00	26.00	VRM01-65	65.00	85.00	5.50	5.50	1.00	73.00
VRM01-22	22.00	40.00	4.00	4.00	1.00	28.00	VRM01-68	68.00	88.00	5.50	5.50	1.00	76.00
VRM01-24	24.00	40.00	4.00	4.00	1.00	30.00	VRM01-70	70.00	90.00	5.50	5.50	1.00	78.00
VRM01-25	25.00	40.00	4.00	4.00	1.00	31.00	VRM01-72	72.00	92.00	5.50	5.50	1.00	80.00
VRM01-26	26.00	40.00	4.00	4.00	1.00	32.00	VRM01-75	75.00	95.00	5.50	5.50	1.00	83.00
VRM01-28	28.00	43.00	4.00	4.00	1.00	34.00	VRM01-78	78.00	98.00	5.50	5.50	1.00	86.00
VRM01-30	30.00	47.00	4.50	4.50	1.00	37.00	VRM01-80	80.00	100.00	5.50	5.50	1.00	88.00
VRM01-32	32.00	49.00	4.50	4.50	1.00	39.00	VRM01-85	85.00	105.00	5.50	5.50	1.00	93.00
VRM01-35	35.00	52.00	4.50	4.50	1.00	42.00	VRM01-90	90.00	110.00	5.50	5.50	1.00	98.00
VRM01-38	38.00	55.00	4.50	4.50	1.00	45.00	VRM01-95	95.00	115.00	5.50	5.50	1.00	103.00
VRM01-40	40.00	57.00	4.50	4.50	1.00	47.00	VRM01-100	100.00	120.00	5.50	5.50	1.00	108.00
VRM01-41	41.00	57.00	4.50	4.50	1.00	47.00	VRM01-105	105.00	125.00	5.50	5.50	1.00	113.00
VRM01-42	42.00	59.00	4.50	4.50	1.00	49.00	VRM01-135	135.00	159.00	6.50	6.50	1.00	145.00

For added protection in extremely contaminated applications, we also offer the type VRM01. The VRM01 seal also seals axially and functions by combining positive lip contact with centrifugal "slinging" action. However, the VRM01 seal is different in that the rubber element is stretch fitted into a metal shell. The metal shell is then press-fitted onto the shaft. This shell provides excellent protection from heavy debris and it automatically accommodates high rotating speeds without auxiliary clamping devices.

#### Advantages/User Benefits:

- The metal shell serves as a support and deflector the rubber body and lip are protected from damage and displacement by external debris (i.e. rocks, viscous media)
- In most cases, the shell also functions as a holder that keeps the rubber lip in position during high surface speeds. No additional axial retention is required.

- Due to its compact design, narrow installation widths are possible.
- Frictional heat build-up and torque drag are very low compared to contracting radial shaft seals.
- Service life is considerably higher than radial seals in contaminated environments and can extend to thousands of hours.

**Construction:** The VRM01 seal lip is made from an 80 durometer nitrile rubber with very good wear resistance.

**Temp-range:** Generally the same as NBR V-rings or -40°C to 100°C (-40°F to 212°F).

N.B.: MINIMUM LINE ORDER MAY APPLY

METRIC SIZE  
V-RINGS



## AXIAL SHAFT SEALS - VRM02

### VRM02

#### Profile and installation dimensions

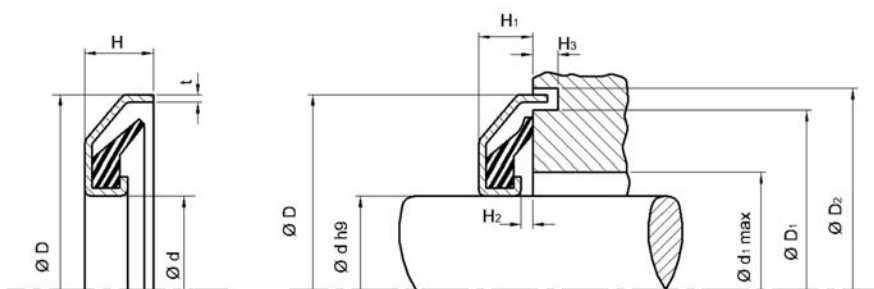

Ref.Number	Nominal Seal Dimensions				Housing Dimensions					
	d	D	H	t	H1	H2	H3	d1	D1	D2
VRM02-15	15.00	32.00	6.00	0.50	4.00	1.00	3.00	21.00	29.00	34.00
VRM02-17	17.00	34.00	6.00	0.50	4.00	1.00	3.00	23.00	31.00	36.00
VRM02-20	20.00	37.00	6.00	0.50	4.00	1.00	3.00	26.00	34.00	39.00
VRM02-25	25.00	42.00	6.00	0.50	4.00	1.00	3.00	31.00	39.00	44.00
VRM02-30	30.00	48.00	6.50	0.50	4.50	1.00	3.00	37.00	45.00	50.00
VRM02-35	35.00	53.00	6.50	0.50	4.50	1.00	3.00	42.00	50.00	55.00
VRM02-40	40.00	58.00	6.50	0.50	4.50	1.00	3.00	47.00	55.00	60.00
VRM02-45	45.00	63.00	6.50	0.50	4.50	1.00	3.00	52.00	60.00	65.00
VRM02-50	50.00	72.00	7.50	0.75	5.50	1.00	3.00	58.00	68.50	74.00
VRM02-55	55.00	77.00	7.50	0.75	5.50	1.00	3.00	63.00	73.50	79.00
VRM02-60	60.00	82.00	7.50	0.75	5.50	1.00	3.00	68.00	78.50	84.00
VRM02-65	65.00	87.00	7.50	0.75	5.50	1.00	3.00	73.00	83.50	89.00
VRM02-70	70.00	92.00	7.50	0.75	5.50	1.00	3.00	78.00	88.50	94.00
VRM02-80	80.00	102.00	7.50	0.75	5.50	1.00	3.00	88.00	98.50	104.00
VRM02-85	85.00	107.00	7.50	0.75	5.50	1.00	3.00	93.00	103.50	109.00
VRM02-90	90.00	112.00	7.50	0.75	5.50	1.00	3.00	98.00	108.50	114.00
VRM02-95	95.00	117.00	7.50	0.75	5.50	1.00	3.00	103.00	113.50	119.00
VRM02-100	100.00	122.00	7.50	0.75	5.50	1.00	3.00	108.00	118.50	124.00

For added protection in extremely contaminated applications, we also offer the type VRM02. The VRM02 seal also seals axially and functions by combining positive lip contact with centrifugal "slinging" action. However, the VRM02 seal is different in that the rubber element is stretch fitted into a metal shell. The metal shell is then press-fitted onto the shaft. This shell provides excellent protection from heavy debris and it automatically accommodates high rotating speeds without auxiliary clamping devices.

#### Advantages/User Benefits:

- The metal shell serves as a support and deflector the rubber body and lip are protected from damage and displacement by external debris (i.e. rocks, viscous media)
- In most cases, the shell also functions as a holder that keeps the rubber lip in position during high surface speeds. No additional axial retention is

required.

- Due to its compact design, narrow installation widths are possible.
- Frictional heat build-up and torque drag are very low compared to contracting radial shaft seals
- Service life is considerably higher than radial seals in contaminated environments and can extend to thousands of hours.

**Construction:** The VRM02 seal lip is made from an 80 durometer nitrile rubber with very good wear resistance.

**Temp-range:** Generally the same as NBR V-rings or -40°C to 100°C (-40°F to 212°F).

N.B.: MINIMUM LINE ORDER MAY APPLY

Tel.: (604) 278-6808  
Fax: (604) 278-6180

**SS 275**

[www.sealsonline.com](http://www.sealsonline.com)

METRIC SIZE  
V-RINGS



**M**

## END CAP - ALL

### END CAP

Profile and installation dimensions

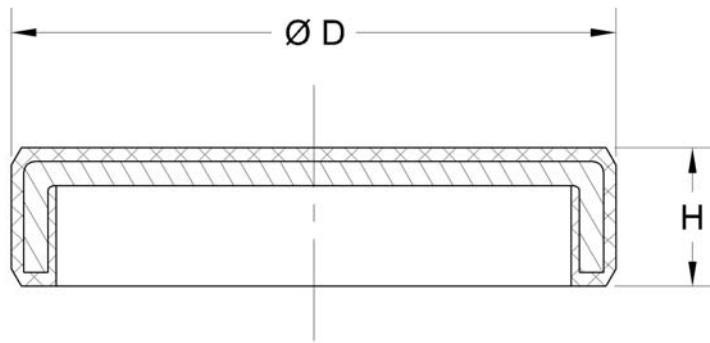

Ref. Number	Dimensions		Ref. Number	Dimensions		Ref. Number	Dimensions	
	D	H		D	H		D	H
EC013-045	13.00	4.50	EC047-100	47.00	10.00	EC120-120	120.00	12.00
EC014-030	14.00	3.00	EC048-040	48.00	4.00	EC120-130	120.00	13.00
EC016-040	16.00	4.00	EC048-050	48.00	5.00	EC125-120	125.00	12.00
EC019-032	19.00	3.20	EC048-066	48.00	6.60	EC130-120	130.00	12.00
EC019-070	19.00	7.00	EC050-050	50.00	5.00	EC130-130	130.00	13.00
EC019-075	19.00	7.50	EC050-100	50.00	10.00	EC140-150	140.00	15.00
EC020-040	20.00	4.00	EC052-065	52.00	6.50	EC145-120	145.00	12.00
EC021-040	21.00	4.00	EC052-070	52.00	7.00	EC150-130	150.00	13.00
EC022-040	22.00	4.00	EC052-100	52.00	10.00	EC150-150	150.00	15.00
EC022-070	22.00	7.00	EC055-090	55.00	9.00	EC160-150	160.00	15.00
EC025-150	25.00	15.00	EC055-100	55.00	10.00	EC168-120	168.00	12.00
EC026-040	26.00	4.00	EC060-070	60.00	7.00	EC170-150	170.00	15.00
EC026-065	26.00	6.50	EC060-080	60.00	8.00	EC180-120	180.00	12.00
EC028-040	28.00	4.00	EC060-100	60.00	10.00	EC200-130	200.00	13.00
EC028-070	28.00	7.00	EC062-070	62.00	7.00	EC210-150	210.00	15.00
EC030-080	30.00	8.00	EC062-080	62.00	8.00	EC230-140	230.00	14.00
EC032-050	32.00	5.00	EC062-100	62.00	10.00			
EC032-070	32.00	7.00	EC062-120	62.00	12.00			
EC032-095	32.00	9.50	EC068-080	68.00	8.00			
EC035-045	35.00	4.50	EC068-085	68.00	8.50			
EC035-070	35.00	7.00	EC072-090	72.00	9.00			
EC035-080	35.00	8.00	EC072-100	72.00	10.00			
EC035-130	35.00	13.00	EC075-070	75.00	7.00			
EC037-050	37.00	5.00	EC075-120	75.00	12.00			
EC037-100	37.00	10.00	EC080-070	80.00	7.00			
EC039-040	39.00	4.00	EC080-100	80.00	10.00			
EC039-050	39.00	5.00	EC080-120	80.00	12.00			
EC040-045	40.00	4.50	EC085-120	85.00	12.00			
EC040-070	40.00	7.00	EC090-080	90.00	8.00			
EC042-060	42.00	6.00	EC090-100	90.00	10.00			
EC042-070	42.00	7.00	EC090-120	90.00	12.00			
EC042-095	42.00	9.50	EC100-100	100.00	10.00			
EC045-070	45.00	7.00	EC100-120	100.00	12.00			
EC047-040	47.00	4.00	EC106-150	106.00	15.00			
EC047-065	47.00	6.50	EC110-100	110.00	10.00			
EC047-070	47.00	7.00	EC110-120	110.00	12.00			

N.B.: MINIMUM LINE ORDER MAY APPLY

METRIC SIZE V-RINGS

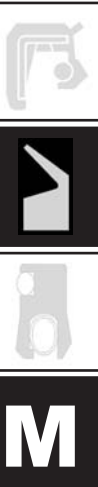

## JD PROFILE - FLANGED ROTARY SEAL



### Applications:

- Best choice for sealing rotating shafts, such as pumps, motors and rotary actuators.
- Suitable for pressures to 3000 psi, 21 MPa.

### Features:

- O.D. flange stabilizes seal, prevents seal rotation and resists thermally induced movement.
- Heavy I.D. seal-lip ensures longest life.
- Dual retained spring-energizer for maximum security.
- Low load high-compliance spring energizer.
- Many high-resilience spring-energizer-options, including choice of light, medium and heavy loads (for friction control) and "NACE" corrosion resistance for oil field use.
- Available with silicone-filled cavity for food and drug applications.

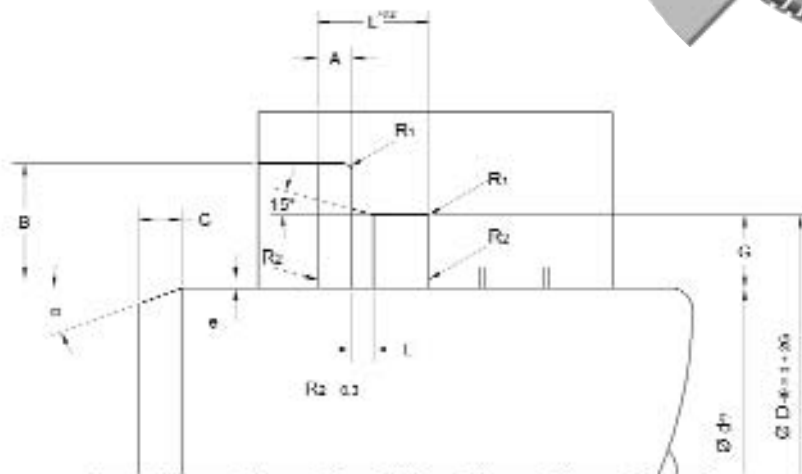

## JD PROFILE - FLANGED ROTARY SEAL

### Cavity Dimensioning

Series no.	Cross section	O'ring cross-sect.	Recommended inner Ø range		Groove width L	Groove depth G	Flange width A	Flange depth B	Chamfer width E	Gap max. e	Radius max. R <sub>1</sub>
			≥	<							
02510	A	2.62	8.00	20.00	3.60	2.50 +0.05	0.85 -0.10	4.50 +0.08	0.80	0.13	0.30
02520	B	3.53	20.00	40.00	4.80	3.50 +0.08	1.35 -0.15	6.25 +0.10	1.10	0.15	0.40
02530	C	5.33	40.00	400.00	7.10	5.25 +0.10	8.75 -0.20	8.75 +0.15	1.40	0.17	0.50
02540	D	6.99	400.00	700.00	9.50	7.00 +0.10	2.80 -0.20	11.00 +0.15	1.60	0.25	0.50

### Cross Section

Where space permits, use of the largest cross section seal is preferred. If specifying a diameter which is above the recommended diameter range, use the largest recommended diameter for the appropriate cross section to determine the cavity tolerances.

### Compound selection

Sealing surface	Medium	POLON® PTFE compound
Steel	Hydraulic oils, Mineral oils, Lubrication oils	POLON® 031, 012, 052
Steel chromium plated	Water/oil emulsions, Hot water and steam	POLON® 031, 074
Cast iron	Unlubricated and lubricated air, Fire resistant fluids, Phosphate ester	POLON® 031, 012, 074
Stainless Steel	Unlubricated and lubricated air, Fire resistant fluids, Phosphate ester	POLON® 301 074
Aluminium hard soft	all above listed	POLON® 031 POLON® 044, 067

### Compound specifications

Reference	Compound	Colour	Temp. (°C)		Application	Characteristics
			min.	max.		
POLON® 012	Modified PTFE	dark green	-190	+230	Low-duty hydraulic applications	Improved wear resistance
POLON® 031	PTFE +15% carbon	black	-190	+290	Medium mechanical stress Hard sealing surfaces water/oil emulsions	Chemical resistance limited by carbon
POLON® 044	PTFE +15% graphite	black	-190	+230	Low mechanical stress Soft sealing surfaces	Chemical resistance limited graphite
POLON® 052	PTFE +40% bronze	bronze	-156	+260	Heavy mechanical stress Hydraulic applications	Outstanding wear and creep resistance
POLON® 067	PTFE +10% ekonol	beige	-260	+320	Medium mechanical stress Soft sealing surfaces Rotary sealing	Limited chemical resistance Limited use in hot water
POLON® 074	PTFE +10% carbon fibre	greyish	-260	+310	Water hydraulics Seawater Short strokes with high frequency	Very good wear properties in water

METRIC SIZE  
SPRING ENERGIZED  
ROTARY SEALS

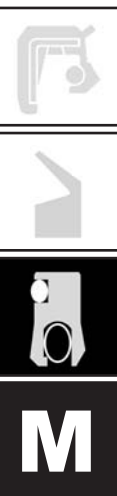

ALSO AVAILABLE

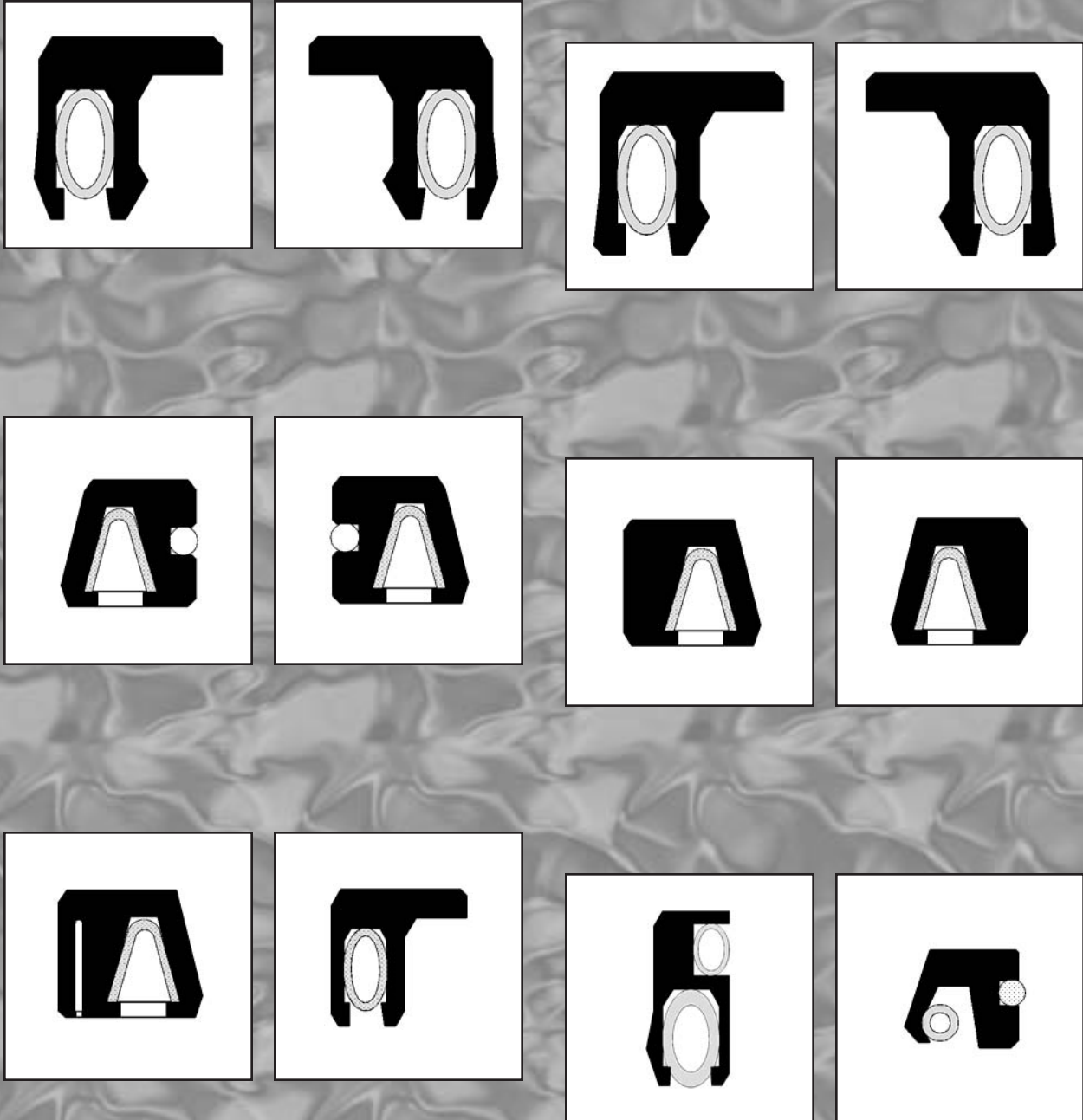

METRIC SIZE  
SPRING ENERGIZED  
ROTARY SEALS



M



## WE'RE EXPANDING OUR FAMILY

### Shaft Seal Catalog



### Seal Catalog



### Seal Kit Catalog



### Industrial Catalog





## ENGINEERING INFORMATION SHEET (OIL SEAL)

- CRITICAL INFORMATION
- ★ MUST INCLUDE TOLERANCE

S/E	A/E	DIS NO	
		DATE	

**CUSTOMER & DIVISION**

**ADDRESS**

**CONTACT**

**CUSTOMER P/N**

● **APPLICATION & TYPE OF EQUIPMENT**

Pos. / unit

● **CUSTOMERS DURABILITY REQUEST**

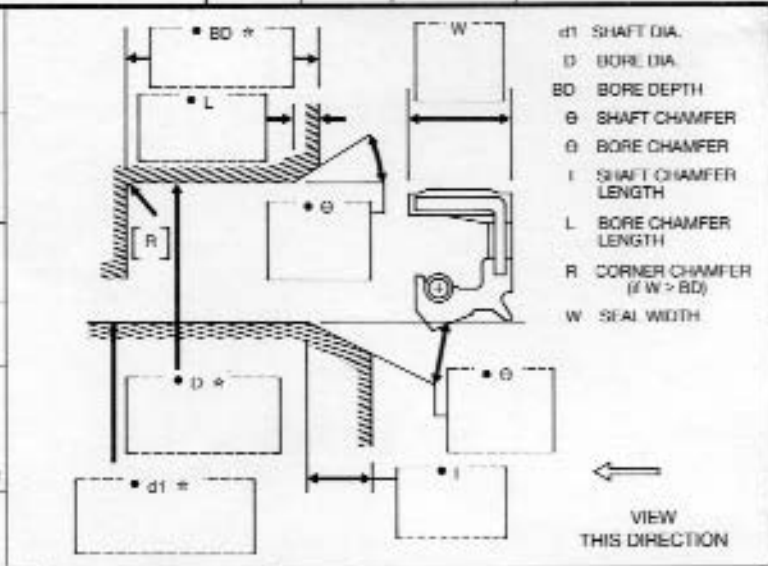

<input type="checkbox"/> OEM <input type="checkbox"/> REPL	<b>PRODUCTION DATE</b>	<b>ANNUAL USAGE</b>	<b>PEAK MO. USAGE</b>	● <b>SHAFT INSTALLATION DIRECTION</b>

<b>SHAFT</b>	<input type="checkbox"/> HORIZONTAL <input type="checkbox"/> VERTICAL	<b>MATERIAL</b>	● <b>ROUGHNESS</b>	● <b>FINISHING METHOD</b>	● <b>HARDNESS</b>
--------------	--	-----------------	--------------------	---------------------------	-------------------

<b>BORE</b>	● <b>MATERIAL</b>	<b>FINISH</b>	<b>HARDNESS</b>	● <b>INSTALLATION DIRECTION INTO BORE</b>

<b>MOTION</b>	<b>ROTATING</b>	● <b>NORMAL RPM</b> _____ ● <b>MAX RPM</b> _____	<b>DIRECTION (VIEWED FROM DUST LIP SIDE)</b> <input type="checkbox"/> C.W. <input type="checkbox"/> C.C.W. <input type="checkbox"/> BI-ROTATIONAL		
	<input type="checkbox"/>	● <b>RUNOUT</b> _____ ● <b>OFFSET</b> _____ ● <b>ENDPLAY</b> _____	<b>FREQUENCY OF ROTATION</b> CONTINUOUS    INTERMITTENT    CYC/DAY		
	<input type="checkbox"/>	● <b>STROKE LENGTH</b> _____ ● <b>DEGREES OF ARC</b> _____ ● <b>CYC/MIN</b> _____	<b>SPECIAL OPERATING CONDITIONS</b>		

<b>MEDIUM TO BE SEALED</b>	<b>IN</b>	● <b>TYPE</b> _____	● <b>LEVEL</b> <input type="checkbox"/> FLOODED <input type="checkbox"/> MIST <input type="checkbox"/> DRY
	<b>OUT</b>	● <b>TYPE</b> _____	

<b>TEMP.</b>	<input type="checkbox"/> °F <input type="checkbox"/> °C	● <b>MINIMUM</b> _____	● <b>NORMAL</b> _____	● <b>MAX</b> _____
--------------	--	------------------------	-----------------------	--------------------

<b>PRESS.</b>	<input type="checkbox"/> PSI <input type="checkbox"/> kPa <input type="checkbox"/> other	● <b>NORMAL</b> _____	● <b>MAX</b> _____	<input type="checkbox"/> CONTIN. PULSAT. <input type="checkbox"/> SPIKE	<b>VALIDATION / IN PROCESS TEST</b> <input type="checkbox"/> YES <input type="checkbox"/> NO
---------------	--	-----------------------	--------------------	--	---

<b>KIND OF BEARING</b>	<input type="checkbox"/> BALL OR ROLLER	<input type="checkbox"/> BUSHING	<b>AUTOMATED ASSBLY</b> <input type="checkbox"/> YES <input type="checkbox"/> NO
------------------------	---	----------------------------------	---















